



**SUBMITTAL
POWER GENERATION EQUIPMENT**

PROJECT NAME: CSDG -4357-4359

MODEL(s): C3000D6EB / 3000kW

CUSTOMER: TBD

SUPPLIER: Cummins Sales and Service

DATE: 12/13/2023

Serving Cummins Customers
in the
Northern Region

NOTICE

A COPY OF THIS SUBMITTAL MUST BE RETURNED TO OUR OFFICE, APPROVED IN ITS ENTIRETY AND BEARING THE DATE OF APPROVAL, STAMP OR SIGNATURE AND TITLE OF THE APPROVING AUTHORITY, BEFORE ANY ITEM WILL BE RELEASED FOR MANUFACTURE OR SHIPMENT. WE ASSUME NO RESPONSIBILITY FOR DELAYS IN OUR FORECASTED SHIPPING SCHEDULES ON ANY ITEM ON WHICH SUBMITTAL APPROVAL IS BEYOND THIRTY (30) DAYS FROM THE SUBMISSION DATE ON THE COVER PAGE.

THIS SUBMITTAL IS BASED UPON OUR INTERPRETATION OF THE PROJECT REQUIREMENTS AND/OR SPECIFICATIONS AND IS IN ACCORDANCE WITH YOUR ORDER AND PRODUCT AVAILABILITY. PLEASE REVIEW THE ENCLOSED DATA COMPLETELY AND CAREFULLY. SHOULD ADDITIONAL INFORMATION OR CLARIFICATION BE REQUIRED, PLEASE FORWARD A SUBMITTAL COPY, COMPLETE WITH YOUR NOTATIONS, TO OUR OFFICE WITHIN THIRTY (30) DAYS FOR A PROMPT RESPONSE AND/OR RESUBMITTAL.

CONSIDERABLE ATTENTION IS GIVEN TO THE PREPARATION OF THIS SUBMITTAL TO ENSURE IT IS COMPLETE, CONCISE AND CORRECT AS POSSIBLE. PLEASE REVIEW IT CAREFULLY AND THOROUGHLY.

For questions or comments regarding this submittal, please contact your Cummins Sales Representative listed on the Cover Page.



Sales and
Service

TABLE OF CONTENTS

Section 1 - Project Information

Project Bill of Material

Section 2 - GENERATOR SPEC SHEETS Generator

Specification Sheet

Generator Data Sheet

PowerCommand Control (PCC) Specification

Sheet Alternator Data Sheet

Section 3 - GENERATOR DRAWINGS

Generator Outline Drawing

Foundation Drawing

Section 4 - STARTUP & WARRANTY

Generator Warranty Statement

Section 5 - INTERCONNECT DRAWINGS

Interconnection Wiring Diagram

Section 1 – Project Information

Generator Bill of Materials

Three (3) new Cummins generator sets, model C3000D6EB, rated at 3000 kW, 277/480-volt, 3 phase, 4 wire, 60 hertz, 1800 RPM, for operation on diesel fuel. Package to include our standard accessories plus the following:

- EPA certified
- UL 2200
- Engine starting batteries - lead acid type
 - Battery rack and cables
 - Battery charger, float type, 20 amps, 24 VDC
 - Battery charging alternator
- Engine jacket water heater
- Alternator heater
- Engine mounted radiator and fan
- Structural steel base rails
- Critical exhaust silencer, set mounted inside enclosure
- Vibration isolators, spring type
- Generator annunciator, ships loose for installation by others
- AmpSentry UL listed protective relay

Cummins UL 508 listed PowerCommand 3.3 Control Panel featuring a microprocessor based digital control system with the following:

- 320 x 240 pixels graphic LED backlight LCD
- Multi language support
- Paralleling capable
- AmpSentry protection to provide true alternator overcurrent protection
- Droop KW and KVAR Control
- Real time clock for fault and event time stamping
- Exerciser clock and time of day start/stop initiate a test with or without load
- Digital voltage regulation
- Modbus interfacing for interconnection to customer equipment
- Configurable inputs and outputs –four (4) discrete inputs and four dry contact relay outputs (3A, 30VDC)
- Data logging to include: engine run time, controller on time, number of start attempts, total kilowatt hours, and load profile.
- Fault history to provide record of the most recent fault conditions with control date and time stamp.
 - Load shed



- LED Indicating lights for the following:
 - Generator running
 - Remote start
 - Not in auto
 - Shutdown
 - Warning
 - Auto
 - Manual and stop
- Alternator Data:
 - Voltage (single or three phase line-to-line and line-to- neutral)
 - Current (single or 3 phase)
 - KW, KVAR, power factor, KVA (three phase and total)
 - Frequency
- Engine Data:
 - Starting battery voltage
 - Engine speed
 - Engine temperature
 - Engine oil pressure
 - Engine oil temperature
 - Intake manifold temperature
 - Comprehensive full authority engine data
- Protective Functions:
 - Battle short mode
 - Derate function
 - Emergency stop
 - Low and high battery voltage warnings
 - Weak battery warning
 - Fail to start (overcrank) shutdown
 - Fail to crank shutdown
 - Cranking lockout
 - Fault simulation
 - Off load running (protection)
 - High AC voltage shutdown
 - Low AC voltage shutdown
 - Under frequency shutdown
 - Over frequency shutdown/warning
 - Overcurrent warning/ shutdown
 - Loss of sensing voltage shutdown



- Field overload shutdown
 - Over load (KW) warning
 - Reverse power shutdown
 - Reverse VAR shutdown
 - Short circuit protection
 - Single and three phase fault regulation
 - Low oil pressure warning and shutdown
 - High coolant temperature warning and shutdown
 - Low coolant level warning and shutdown
 - Low coolant temperature warning
 - Sensor failure indicator
-
- Left facing control
 - Configurable output relays
 - Analog meters – AC output
 - PMG exciter
 - Isochronous electronic governor
 - 125 degree C rise alternator over 40 degree C ambient
 - Two (2) year warranty
 - Lube oil and antifreeze

Section 2 – Generator Spec Sheets



Centum™ Series Generators QSK78

3000 kW 60 Hz

Emissions Regulated

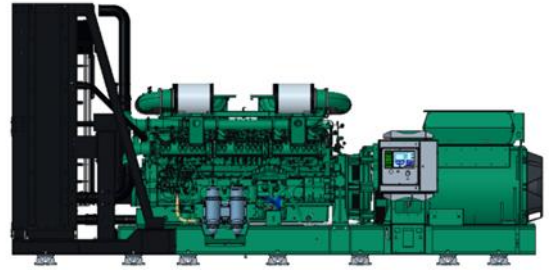

Note: This document is preliminary. Not all stated specifications, features and options may be immediately available, and some details will be subject to change. Please check for latest information and revision.

Description

Cummins® commercial generator sets are fully integrated power generation systems providing optimum performance, reliability, and versatility for stationary Standby, ¹Prime Power and Data Center applications.

Features

Cummins heavy-duty engine - Rugged 4-cycle, industrial diesel delivers reliable power, low emissions and fast response to load changes.

HVO Fuel Compatible – Approved for use with paraffinic fuels (EN15940), including Hydrotreated vegetable oil which has a very low life cycle carbon emission.

Alternator - Several alternator sizes offer selectable motor starting capability with low reactance 2/3 pitch windings, low waveform distortion with non-linear loads and fault clearing short-circuit capability.

Permanent Magnet Generator (PMG) - Offers enhanced motor starting and fault clearing short circuit capability.

Control system - The PowerCommand® electronic control is standard equipment and provides total genset system integration including automatic remote starting/stopping, precise frequency and voltage regulation, alarm and status message display, AmpSentry™ protection, output metering, auto-shutdown at fault detection and NFPA 110 Level 1 compliance.

Cooling system - Standard and enhanced integral set-mounted radiator systems, designed and tested for rated ambient temperatures to simplify the facility design requirements for rejected heat.

Warranty and service - Backed by a standard standby two-year warranty and worldwide distributor network.

NFPA - The generator set accepts full rated load in a single step in accordance with NFPA 110 Level 1 systems.

	Standby rating	¹ Prime rating	Data Centre Continuous rating	Emissions Compliance
Model	60 Hz kW (kVA)	60 Hz kW (kVA)	60 Hz kW (kVA)	
C3000D6EB	3000 (3750)	2725 (3406)	2725 (3406)	EPA Tier 2

Notes:
All ratings include radiator fan losses.
¹Prime rating data provided for reference only.

Generator set specifications

Performance class	Genset models have been tested in accordance with ISO 8528-5. Consult factory for transient performance information
Steady state voltage regulation, no load to full load	± 1.0% (TBC)
Random voltage variation	± 1.0% (TBC)
Frequency regulation	Isochronous
Steady state frequency band	± 0.5% (TBC)
Electromagnetic Compatibility Performance	Emissions to EN 61000-6-2:2005 Immunity to EN 61000-6-4:2007+A1:2011 FCC PART 15 subpart B; ICES-002

Engine specifications

Bore	170.0 mm (6.69 in)
Stroke	190.0 mm (7.48 in)
Displacement	77.6 litres (4735 in ³)
Configuration	Cast iron, V 18 cylinder
Battery capacity	2200 amps minimum at ambient temperature of -18 °C to 0 °C (0 °F to 32 °F)
Battery charging alternator	55 amps
Starting voltage	24 volt, negative ground
Fuel system	Cummins' modular common rail system
Fuel filter	Two stage fuel filtration system with remote mounted stage 1 unit including water separation.
Air cleaner type	Unhoused dry replaceable element as standard; heavy duty optional
Lube oil filter type(s)	Six spin-on, combination full flow filter and bypass filters
Standard cooling system	High ambient cooling system (Ship Loose)

Alternator specifications

Design	Brushless, 4 pole, drip proof, revolving field
Stator	2/3 pitch
Rotor	Two bearing, flexible coupling
Insulation system	Class H
Standard temperature rise	150 °C Standby at 40 °C ambient
Exciter type	Permanent Magnet Generator (PMG)
Phase rotation	A (U), B (V), C (W)

Available voltages

60 Hz Line-Neutral/Line-Line

- | | | | |
|------------------|-----------|--------------|--------------|
| • 240/416 | • 347/600 | • 2400/4160 | • 7621/13200 |
| • 277/480 | | • 7200/12470 | • 7976/13800 |

Note: Consult factory for other voltages.

Generator set options and accessories

Engine

- **480V, 3P, 12kW forced type coolant heaters.**
- Heavy-duty air cleaners
- **Oil Sampling Valve**
- **Redundant Starting**
- **Closed Crankcase Ventilation**

Cooling system

- **High ambient air temperature (ship loose)**
- Enhanced high ambient air temperature (ship loose)

Control panel

- Multiple language support
- **left facing mounting**
- Masterless load demand
- **Warning high bearing temperature**

Generator set options and accessories (continued)

Control panel

- Alternator temperature monitoring
- Exhaust gas temperature monitoring
- 6x user-configurable relays
- 120/240 V Heater control cabinet
- Mechanical hour meter
- 2x digital input/output

Exhaust system

- Residential grade exhaust silencer
- Critical grade exhaust silencer

Generator set

- Battery
- Battery rack with hold-down - floor standing
- PowerCommand network
- Remote annunciator panel
- Vibration isolators
- Standby 2,3,4 & 5YR limited hour warranties available.
- DCC 2,3,5 & 10YR unlimited hour warranties available.

Alternator

- 80 °C rise
- 105 °C rise
- 125 °C rise
- 150 °C rise
- 120/240 V 300 W anti-condensation heater
- Temperature sensor - RTDs, 2/phase
- Temperature sensor – alternator bearing RTD
- Differential current transformers

Note: Some options may not be available on all models - consult factory for availability.

PowerCommand 3.3 – control system



The PowerCommand control system is an integrated microprocessor based generator set control system providing voltage regulation, engine protection, alternator protection, operator interface and isochronous governing.

AmpSentry – Includes integral AmpSentry protection, which provides a full range of alternator protection functions that are matched to the alternator provided.

Power management – Control function provides battery monitoring and testing features and smart starting control system.

Advanced control methodology – Three phase sensing, full wave rectified voltage regulation, with a PWM output for stable operation with all load types.

Communications interface – Control comes standard with PCCNet and Modbus interface.

Service - InPower™ PC-based service tool available for detailed diagnostics, setup, data logging and fault simulation.

Reliable design – The control system is designed for reliable operation in harsh environment.

Multi-language support

Operator panel features

Operator panel features – The operator panel, in addition to the alternator, displays the Utility/AC bus data.

Operator/display functions

- 320 x 240 pixels graphic LED backlight LCD
- Auto, manual, start, stop, fault reset and lamp test/panel lamp switches
- Alpha-numeric display with pushbuttons
- LED lamps indicating genset running, remote start, not in auto, common shutdown, common warning, manual run mode, auto mode and stop.

Paralleling control functions

- Digital frequency synchronization and voltage matching
- Isochronous kW and kVar load sharing controls
- Droop kW and kVar control
- Sync check
- Extended paralleling (peak shave/base load)
- Digital power transfer control (AMF) provides load transfer operation in open or closed transition or soft (ramping) transfer mode

Alternator data

- Line-to-Neutral and Line-to-Line AC volts
- 3-phase AC current
- Frequency
- kW, kVar, power factor kVA (three phase and total)

Engine data

- DC voltage
- Engine speed
- Lube oil pressure and temperature
- Coolant temperature
- Comprehensive FAE data (where applicable)

Other data

- Genset model data
- Start attempts, starts, running hours, kW hours
- Load profile (operating hours at % load in 5% increments)
- Fault history
- Data logging and fault simulation (requires InPower)

Standard control functions

Digital governing (optional)

- Integrated digital electronic isochronous governor
- Temperature dynamic governing

Digital voltage regulation

- Integrated digital electronic voltage regulator
- 3-phase, 4-wire Line-to-Line sensing
- Configurable torque matching

Standard control functions (continued)

AmpSentry AC protection

- AmpSentry protective relay
- Over current and short circuit shutdown
- Over current warning
- Single and three phase fault regulation
- Over and under voltage shutdown
- Over and under frequency shutdown
- Overload warning with alarm contact
- Reverse power and reverse Var shutdown
- Field overload

Engine protection

- Battery voltage monitoring, protection and testing
- Overspeed shutdown
- Low oil pressure warning and shutdown
- High coolant temperature warning and shutdown
- Low coolant level warning or shutdown
- Low coolant temperature warning
- Fail to start (overcrank) shutdown
- Fail to crank shutdown

- Cranking lockout
- Sensor failure indication
- Low fuel level warning or shutdown
- Fuel-in-rupture-basin warning or shutdown
- Full authority electronic engine protection

Control functions

- Time delay start and cool down
- Real time clock for fault and event time stamping
- Exerciser clock and time of day start/stop
- Data logging
- Cycle cranking
- Load shed
- Configurable inputs and outputs (4)
- Remote emergency stop

Options

- Auxiliary output relays (2)

Ratings definitions

Emergency Standby Power (ESP):

Applicable for supplying power continuously to varying electrical loads for the duration of power interruption of a reliable utility source. Emergency Standby Power (ESP) is in accordance with ISO 8528 and ISO 3046-1, obtained and corrected in accordance with ISO 15550).

Prime Power (PRP):

Applicable for supplying power to varying electrical loads for unlimited hours. Prime Power (PRP) is in accordance with ISO 8528. Ten percent overload capability is available in accordance with ISO 3046, Data shown above represents gross engine performance and capabilities as per ISO 3046-1, obtained and corrected in accordance with ISO 15550

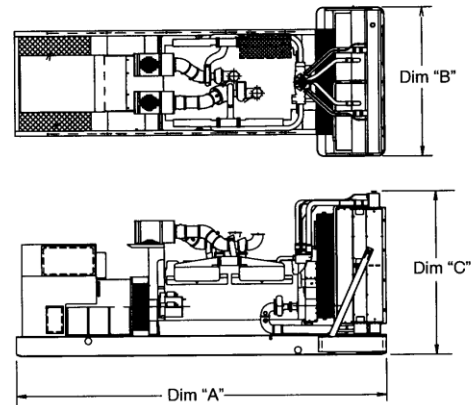

This outline drawing is for reference only. See respective model data sheet for specific model outline drawing number.

Notes

¹Rating definitions provided for reference only.



Do not use for installation design

Model	Dim "A" mm (in.)	Dim "B" mm (in.)	Dim "C" mm (in.)	Set weight* dry kg (lbs)	Set weight* wet kg (lbs)
C3000D6EB	7075 (278.5)	2610 (102.75)	3500 (137.79)	TBC	TBC

Notes: * With standard features and S9 alternator. See outline drawings for other configurations.

Codes and standards

Codes or standards compliance may not be available with all model configurations – consult factory for availability.

<p>ISO 9001 ISO 14001 ISO 45001</p>	<p>This product was manufactured in a facility whose quality management system is certified to ISO 9001 and its Health Safety Environmental Management Systems certified to ISO 14001 and ISO 45001.</p>	<p>U.S. EPA</p>	<p>Engine certified to Stationary Emergency U.S. EPA New Source Performance Standards, 40 CFR 60 subpart IIII Tier 2 exhaust emission levels. U.S. applications must be applied per this EPA regulation.</p>
	<p>All genset models are available as CSA certified to CSA C22.2 No.100</p>	<p>International Building Code</p>	<p>The generator set package is available certified for seismic application in accordance with International Building Code</p>
	<p>The generator set is available listed to UL 2200 for all 60 Hz low voltage models, Stationary Engine Generator Assemblies. The PowerCommand control is Listed to UL 508 - Category NITW7 for U.S. and Canadian usage.</p>		<p>The Prototype Test Support (PTS) program verifies the performance integrity of the generator set design. Cummins products bearing the PTS symbol meet the prototype test requirements of NFPA 110 for Level 1 systems.</p>

For more information contact your local Cummins distributor or visit [cummins.com](https://www.cummins.com)

Our energy working for you.™



Generator Set Data Sheet



Model: C3000D6EB
Frequency: 60 Hz
Fuel Type: Diesel
kW Rating: 3000 Standby
Emissions level: Pending PEPA NSPS Stationary Emergency Tier 2

Exhaust emission data sheet:	TBC
Exhaust emission compliance sheet:	TBC
Sound performance data sheet:	TBC
Cooling performance data sheet:	TBC
Prototype test summary data sheet:	TBC
Remote radiator cooling outline:	N/A
High ambient cooling system outline (ship loose):	TBC
Enhanced high ambient cooling system outline (ship loose):	TBC

Fuel Consumption*	Standby			
	kW (kVA)			
Ratings	3000 (3750)			
Load	1/4	1/2	3/4	Full
US gph	61	109	159	210
L/hr	230	413	602	796

* Tolerance within +/- 10%

Engine*	Standby rating
Engine manufacturer	Cummins Inc.
Engine model	QSK78-G37
Configuration	Cast Iron, V 18 cylinder
Aspiration	Turbocharged and charge air cooled (air to air)
Gross engine power output, kWm (bhp)	3312 (4441)
BMEP at set rated load, kPa (psi)	2848 (413)
Bore, mm (in.)	170.0 (6.69)
Stroke, mm (in.)	190.0 (7.48)
Rated speed, rpm	1800
Piston speed, m/s (ft/min)	11.4 (2243)
Compression ratio	15.5:1
Lube oil capacity, L (qt)	413 (436)
Overspeed limit, rpm	1980
Regenerative power, kW	256

* Tolerance within +/- 10%

Fuel Flow*	Standby rating
Maximum fuel flow, L/hr (US gph)	1733 (458)
Maximum fuel inlet restriction with clean filters, kPa (in Hg)	20 (6)
Maximum fuel inlet restriction with dirty filters, kPa (in Hg)	34 (10)
Maximum fuel return restriction, kPa (in Hg)	15 (4.5)
Maximum fuel inlet temperature, °C (°F)	70 (158)

* Tolerance within +/- 10%

Air*

Combustion air, m ³ /min (scfm) – Normal Duty	267 (9434)
Maximum air cleaner restriction, kPa (in H ₂ O)	6 (25)
Alternator cooling air, m ³ /min (cfm)	3.3 (118)

* Tolerance within +/- 10%

Exhaust*

Exhaust flow at set rated load, m ³ /min (cfm)	671 (23680)
Exhaust temperature, °C (°F)	479 (894)
Maximum back pressure, kPa (in H ₂ O)	6.8 (27.3)

* Tolerance within +/- 10%

High Ambient Cooling System*† (ship loose)

Ambient design, °C (°F)	40 (104)
Coolant capacity (with radiator), L (US gal)	450 (119)
Cooling system air flow, m ³ /min (scfm)	2700 (83400)
Maximum cooling air flow static restriction, kPa (in H ₂ O)	0.25 (1.0)

* Tolerance within +/- 10%

† Values subject to change

Enhanced High Ambient Cooling System (ship loose)

Ambient design, °C (°F)	50 (122)
Coolant capacity (with radiator), L (US gal)	TBC
Cooling system air flow, m ³ /min (scfm)	TBC
Maximum cooling air flow static restriction, kPa (in H ₂ O)	TBC

Weights¹

Unit dry weight kgs (lbs)	24700 (54454)
Unit wet weight kgs (lbs)	25500 (56218)

¹ Weights represent a set with standard features with cooling system assembled.

Connection ¹	Temp rise °C	Duty	Alternator	Voltage
Wye	80, 105, 125, 150	ESP, DCC	S9 D, E, F, G	416, 480, 600
Wye	80, 105, 125, 150	ESP, DCC	S9 E, F, G, H	4160
Wye	80, 105, 125, 150	ESP, DCC	S9 E, F, G, H	12470, 13200, 13800

Notes:

¹ Single phase power can be taken from three phase generator sets at up to the value listed in the single phase factor column for the generator set nameplate kW rating at unity power factor.

Ratings Definitions

Emergency Standby Power (ESP):
Applicable for supplying power to varying electrical load for the duration of power interruption of a reliable utility source. Emergency Standby Power (ESP) is in accordance with ISO 8528. Fuel stop power in accordance with ISO 3046, AS 2789, DIN 6271 and BS 5514.

Data Center Continuous (DCC):
Applicable for supplying power continuously to a constant or varying electrical load for unlimited hours in a data center application.

Notes:

Rating definitions provided for reference only

Formulas for Calculating Full Load Currents:

Three phase output	Single phase output
$\frac{\text{kW} \times 1000}{\text{Voltage} \times 1.73 \times 0.8}$	$\frac{\text{kW} \times \text{SinglePhaseFactor} \times 1000}{\text{Voltage}}$

Warning: Back feed to a utility system can cause electrocution and/or property damage. Do not connect to any building's electrical system except through an approved device or after building main switch is open.

	Engine Performance Data Cummins Inc. Columbus, Indiana 47202-3005 http://www.cummins.com		CPG		Date 31-Aug-23		
			QSK78-G37 FR60719		Configuration D773005GX03	CPL 5909	Revision -
Compression Ratio	15.5:1		Displacement		77.6 L (4737 in ³)		
Fuel System	Cummins MCRS		Aspiration		Turbocharged and Charge Air Cooled		
Aftertreatment	None		Emission Compliance		EPA Tier 2 (NSPS)		

Engine Speed		Standby Power		Prime Power		Continuous Power	
rpm	kWm	bhp	kWm	bhp	kWm	bhp	
1800	3312	4441	N/A	N/A	N/A	N/A	

Nominal Exhaust Emissions Data @ 1800 rpm

Component	STANDBY			PRIME			CONTINUOUS		
	g/bhp-hr	mg/m3	PPM	g/bhp-hr	mg/m3	PPM	g/bhp-hr	mg/m3	PPM
HC (Total Unburned Hydrocarbons)	0.07	36	57	N/A	N/A	N/A	N/A	N/A	N/A
NOx (Oxides of Nitrogen as NO ₂)	6.12	2948	1437	N/A	N/A	N/A	N/A	N/A	N/A
CO (Carbon Monoxide)	0.06	30	24	N/A	N/A	N/A	N/A	N/A	N/A
PM (Particulate Matter)	0.01	3	N/A	N/A	N/A	N/A	N/A	N/A	N/A
SO ₂ (Sulfur Dioxide)	0.004	2	1	N/A	N/A	N/A	N/A	N/A	N/A

ATTENTION: This data was taken from a single engine test according to the Test Methods and Conditions specified below. This data is subject to instrumentation, measurement, and engine-to-engine variability. Field emissions test data is not guaranteed to these levels. For air permit programs, please contact Application Engineering for potential site variation.

CO₂ emissions can be calculated using the EPA recommended conversion factor of 10.18 kg of CO₂ emissions per gallon of Ultra-Low Sulfur Diesel #2 fuel consumed.

Note: mg/m³ and PPM numbers are measured dry and corrected to 5% O₂ content. mg/m³ values are normalized to standard temperature and pressure (0°C, 101.325 kPa).

Test Methods and Conditions:

Steady-State emissions recorded per ISO8178-1 during operation at rated engine speed (+/- 2%) and stated constant load (+/-2%) with engine temperatures, pressures, and emission rates stabilized.

Fuel Specification:

52-54 Cetane Number (EU), 42-48 Cetane Number (EPA), 0.0015 Max. Wt. % Sulfur.

Reference:

25 °C (77°F) Air inlet Temperature, 40 °C (104°F) Fuel inlet Temperature, 100 kPa (29.53 in Hg) Barometric Pressure; 10.7 g/kg (75 grains H₂O/lb) of dry air Humidity (required for NOx correction); Intake Restriction set to Max allowable limit for clean filter; Exhaust Back Pressure set to Max allowable limit.

Data subject to change without notice.



September 14th, 2023

To Whom It May Concern:

The transient test data shown below was conducted at a Cummins factory for the C3000D6EB generator set with the following configuration:

- Rated 3000 kW
- 480 V 60Hz (S9G) alternator
- Centum QSK78 diesel engine

This electrical performance may vary slightly for each generator set of this model due to performance in other applications that may be impacted by product installation, test methodology, variables during tests, environmental/site conditions and/or other factors.

C3000D6EB Generator Set Load Transient Test Data at 0.8 PF

Load Step Profile	Voltage Excursion as % of rated load	Voltage Excursion Recovery Time (sec)	Frequency Excursion as % of rated load	Frequency Excursion Recovery Time (sec)
ISO8528 BMEP (0-25%-42%-56%-71%-85%-100%) (100%-0)	G3	G3	G3	G3
0 – 50%	16.37	3.16	6.10	4.29
50% – 0	9.14	1.54	3.52	2.14

This test results were captured at test cell conditions at nominal temperature and altitude. This letter does not supersede any of the commercial terms of sale, including, but not limited to, warranty coverage and compliance with law obligations. THE INFORMATION IN THIS LETTER IS PROVIDED “AS IS” AND WITH ALL FAULTS AND DEFECTS. CUMMINS DOES NOT WARRANT THE ACCURACY OF THE INFORMATION PROVIDED AND THIS LETTER SHOULD NOT BE SHARED WITH THIRD PARTIES WITHOUT CUMMINS PRIOR WRITTEN CONSENT. For further questions on this product or application, please contact the local Cummins Sales and Service representative.

Best Regards,

Rina Pineda Alvarado
Application Engineer – Strategic Accounts (Data Center)
Cummins Power Generation

STAMFORD®

S9L1D-E4 Wdg.312 - Technical Data Sheet

Standards

STAMFORD industrial alternators meet the requirements of the relevant parts of the IEC 60034 and the relevant sections of other international standards such as BS5000-3, ISO 8528-3, VDE 0530, NEMA MG1-32, CSA C22.2-100 and AS 60034. Other standards and certifications can be considered on request.

Quality Assurance

Alternators are manufactured using production procedures having a quality assurance level to BS EN ISO 9001.

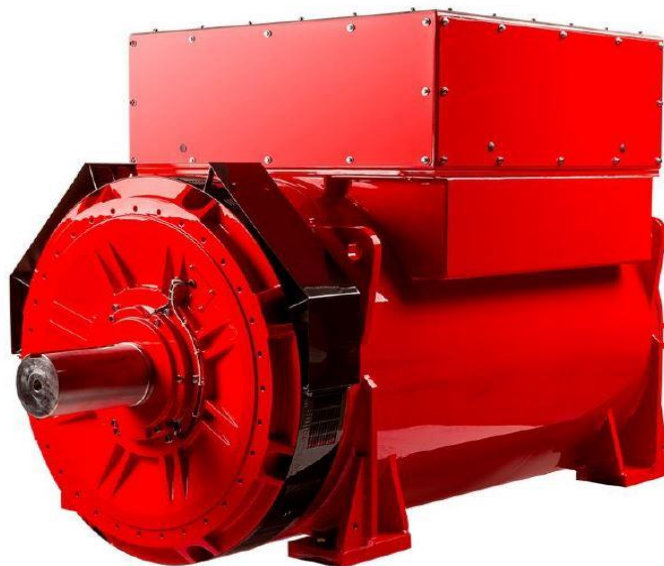

Excitation and Voltage Regulators

Excitation System					
AVR Type	DM110	DECS100	DECS150		
Voltage Regulation	± 0.25%	± 0.25%	± 0.25%		with 4% Engine Governing
AVR Power	PMG	PMG	PMG		

No Load Excitation Voltage (V)	17.1 - 15.8
No Load Excitation Current (A)	1 - 0.9
Full Load Excitation Voltage (V)	71
Full Load Excitation Current (A)	4
Exciter Time Constant (seconds)	0.194

STAMFORD®

S9L1D-E4 Wdg.312

Electrical Data								
Insulation System	H							
Stator Winding	Double Layer Concentric							
Winding Pitch	2/3							
Winding Leads	6							
Winding Number	312							
Number of Poles	4							
IP Rating	IP23							
RFI Suppression	BS EN 61000-6-2 & BS EN 61000-6-4, VDE 0875G, VDE 0875N. Refer to factory for others							
Waveform Distortion	NON-DISTORTING BALANCED LINEAR LOAD < 5.0%							
Short Circuit Ratio	1/Xd							
Steady State X/R Ratio	27.85							
50 Hz				60 Hz				
Telephone Interference	THF<2%				TIF<50			
Cooling Air Flow	2.78 m³/sec				3.33 m³/sec			
Voltage Star (V)	300	400	415	430	416	440	460	480
Voltage Parallel Star (V)	-	-	-	-	-	-	-	-
Voltage Delta (V)	-	-	-	-	-	-	-	-
kVA Base Rating (Class H) for Reactance Values (kVA)	3375	3555	3555	3340	3390	3800	3939	4142
Saturated Values in Per Unit at Base Ratings and Voltages								
Xd Dir. Axis Synchronous	2.304	2.190	2.075	1.700	2.454	2.322	2.219	2.126
X'd Dir. Axis Transient	0.217	0.216	0.192	0.160	0.231	0.219	0.209	0.200
X''d Dir. Axis Subtransient	0.115	0.109	0.101	0.085	0.122	0.115	0.110	0.106
Xq Quad. Axis Reactance	1.220	1.160	1.078	0.901	1.300	1.230	1.175	1.126
X''q Quad. Axis Subtransient	0.126	0.120	0.111	0.093	0.134	0.127	0.122	0.117
XL Stator Leakage Reactance	0.074	0.070	0.065	0.054	0.078	0.074	0.071	0.068
X2 Negative Sequence Reactance	0.205	0.195	0.181	0.151	0.218	0.207	0.198	0.189
X0 Zero Sequence Reactance	0.083	0.079	0.073	0.061	0.089	0.084	0.080	0.077
Unsaturated Values in Per Unit at Base Ratings and Voltages								
Xd Dir. Axis Synchronous	2.764	2.628	2.441	2.041	2.944	2.786	2.662	2.552
X'd Dir. Axis Transient	0.249	0.237	0.220	0.184	0.266	0.251	0.240	0.230
X''d Dir. Axis Subtransient	0.134	0.127	0.118	0.099	0.143	0.135	0.129	0.124
Xq Quad. Axis Reactance	1.257	1.195	1.110	0.928	1.339	1.267	1.210	1.160
X''q Quad. Axis Subtransient	0.151	0.144	0.134	0.112	0.161	0.153	0.146	0.140
XL Stator Leakage Reactance	0.083	0.079	0.073	0.061	0.089	0.084	0.080	0.077
Xlr Rotor Leakage Reactance	0.095	0.090	0.084	0.071	0.101	0.095	0.091	0.087
X2 Negative Sequence Reactance	0.246	0.234	0.217	0.182	0.262	0.248	0.237	0.227
X0 Zero Sequence Reactance	0.097	0.092	0.086	0.072	0.104	0.098	0.094	0.090

STAMFORD

S9L1D-E4 Wdg.312

Time Constants (Seconds)		
T'd Transient Time Const.	0.24	
T''d Sub-Transient Time Const.	0.0163	
T'do O.C. Field Time Const.	4.16	
Ta Armature Time Const.	0.034	
T''q Sub-Transient Time Const.	0.01	
Resistances in Ohms (Ω) at 22°C		
Stator Winding Resistance (Ra), per phase for series connected	0.0003292	
Rotor Winding Resistance (Rf)	1.56	
Exciter Stator Winding Resistance	16.1	
Exciter Rotor Winding Resistance per phase	0.03415	
PMG Phase Resistance (Rpmg) per phase	1.91	
Positive Sequence Resistance (R1)	0.00041	
Negative Sequence Resistance (R2)	0.00047	
Zero Sequence Resistance (R0)	0.00041	
Saturation Factors	400V	480V
SG1.0	0.191	0.19
SG1.2	0.892	0.902
Mechanical Data		
Shaft and Keys	All alternator rotors are dynamically balanced to better than ISO 21940-11 Grade 2.5 for minimum vibration in operation. Two bearing generators are balanced with a half key.	
	1 Bearing	2 Bearing
SAE Adaptor		0, 00, None
Moment of Inertia	-	102.5 kgm ²
Weight Wound Stator	-	2763kg
Weight Wound Rotor	-	2384kg
Weight Complete Alternator	-	7149kg
Shipping weight in a Crate	-	7549kg
Packing Crate Size	-	280 x 200 x 220(cm)
Maximum Over Speed	2250 RPM for two minutes	
Bearing Drive End	-	6236
Bearing Non-Drive End	-	6324

STAMFORD®

S9L1D-E4 Wdg.312

THREE PHASE EFFICIENCY CURVES

50Hz

60Hz

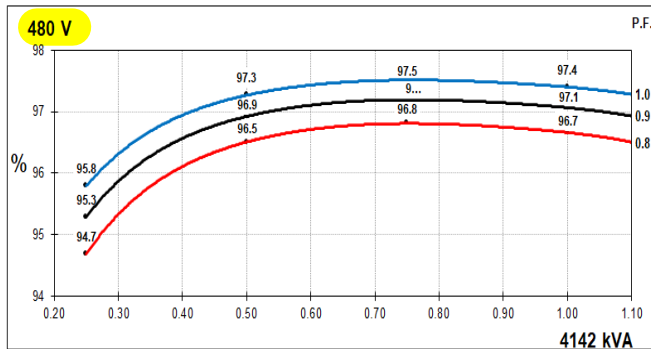
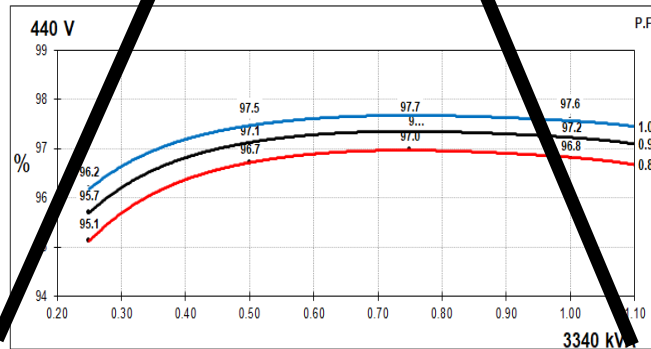
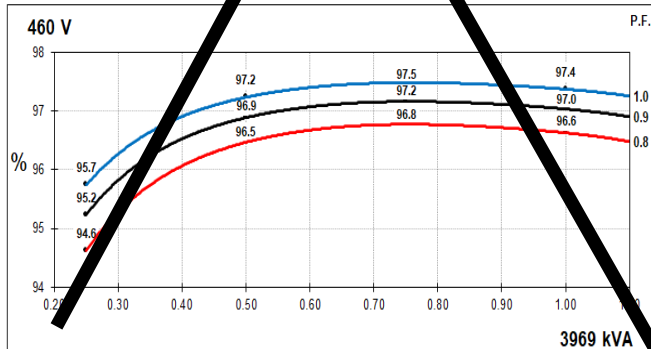
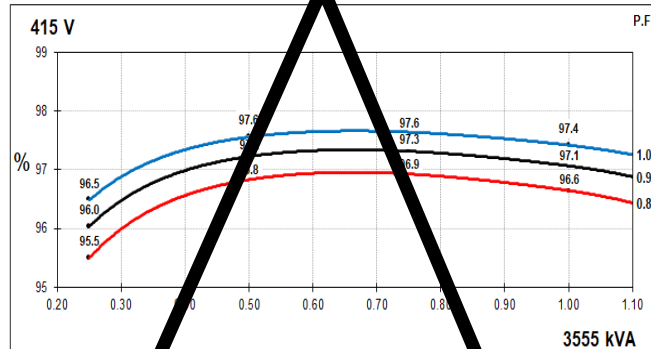
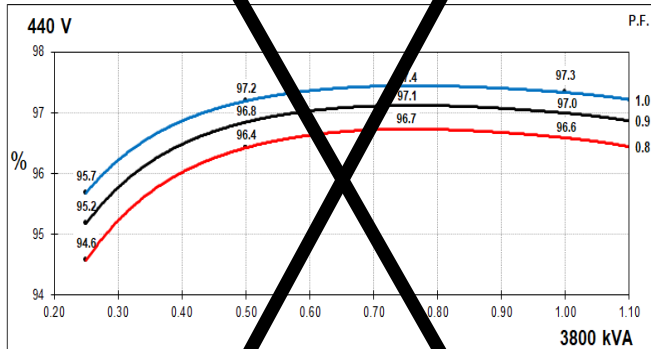
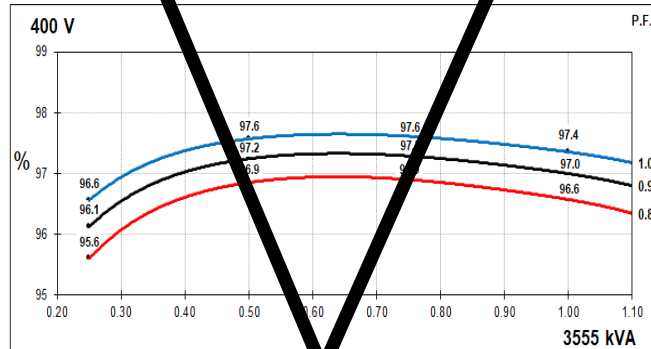
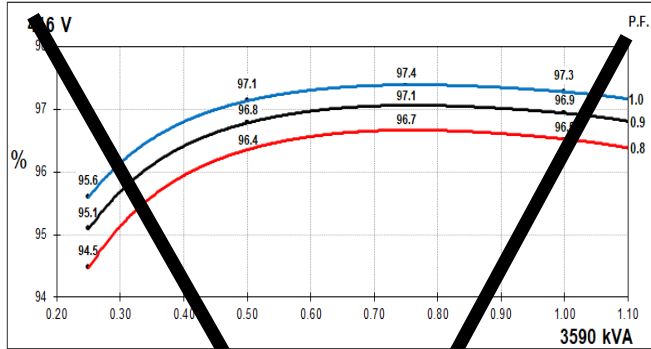
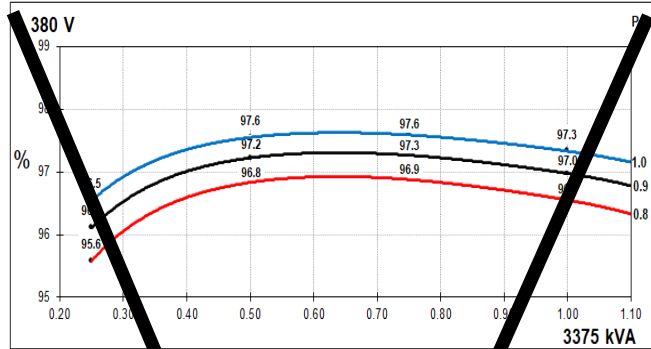

STAMFORD

S9L1D-E4 Wdg.312

Locked Rotor Motor Starting Curves - Separately Excited

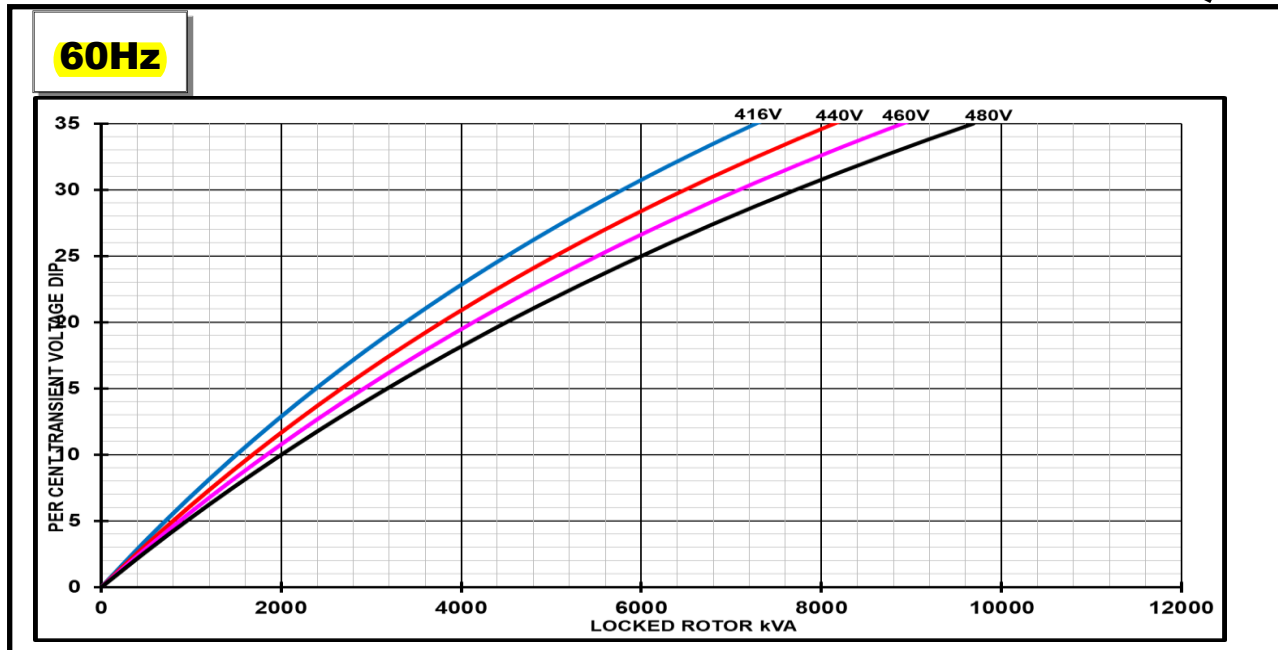
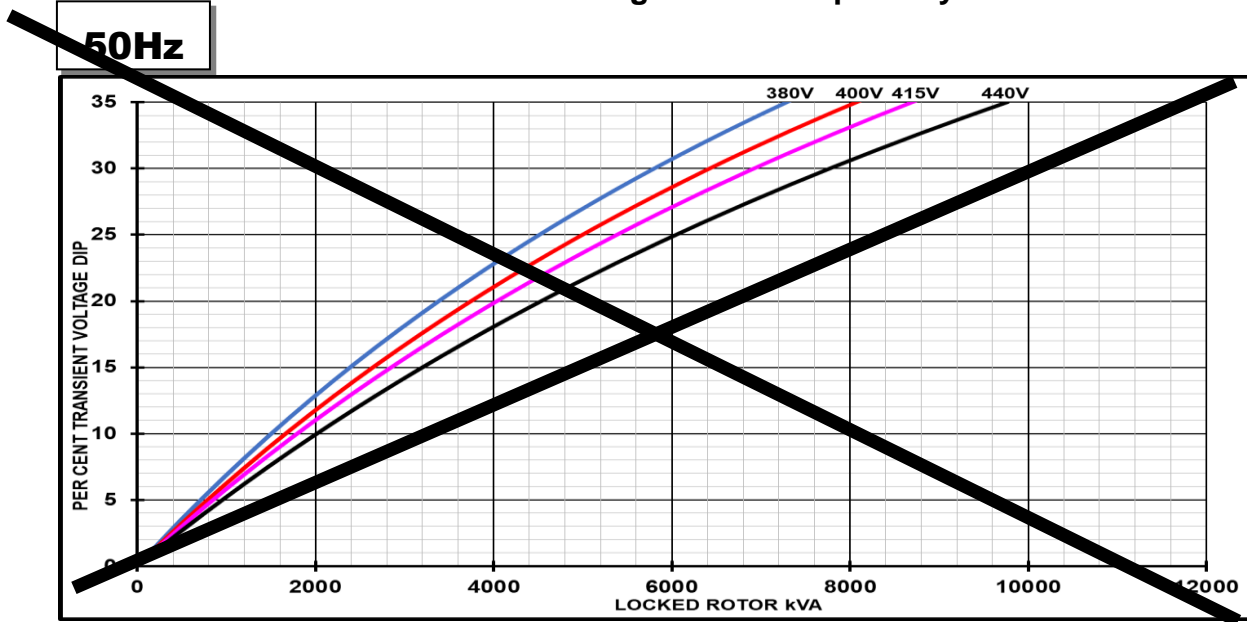

Transient Voltage Dip Scaling Factor		Transient Voltage Rise Scaling Factor	
Lagging PF	Scaling Factor	Lagging PF	Scaling Factor
<= 0.4	1.00	<= 0.4	1.25
0.5	0.95	0.5	1.20
0.6	0.90	0.6	1.15
0.7	0.86	0.7	1.10
0.8	0.83	> 0.7	1.00
0.9	0.75		
0.95	0.70		
1	0.65		

Note: To determine % Transient Voltage Dip or Voltage Rise at various PF, multiply the % Voltage Dip from the curve directly by the Scaling Factor.

STAMFORD®

S9L1D-E4 Wdg.312

Three-phase Short Circuit Decrement Curve - Separately Excited

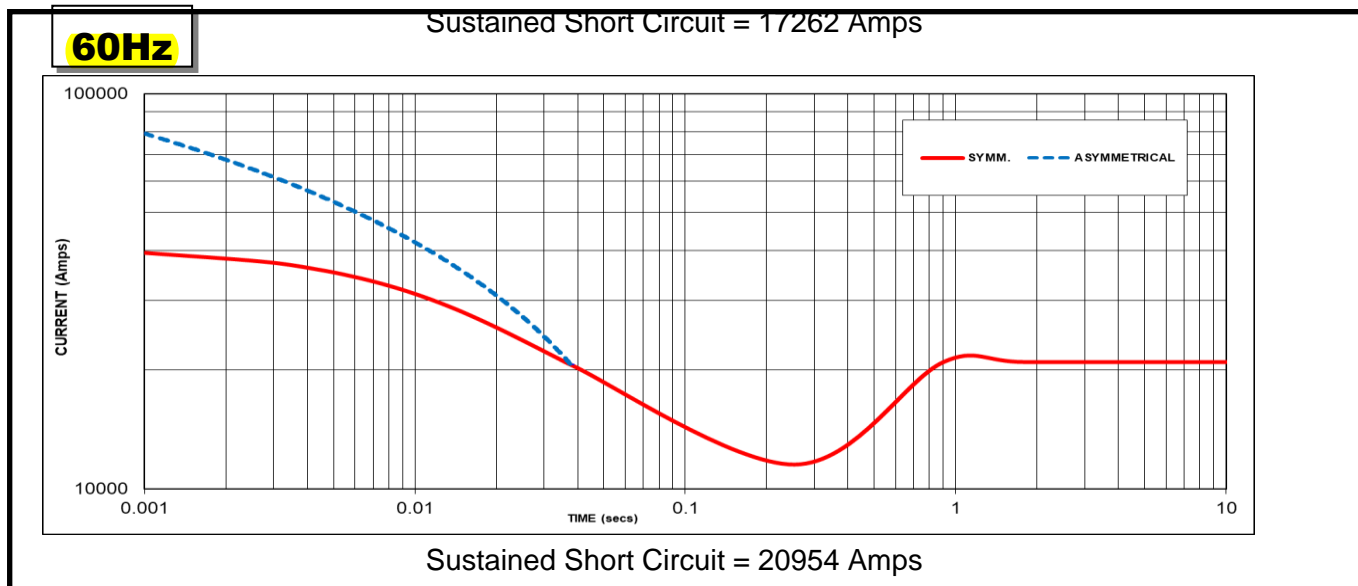
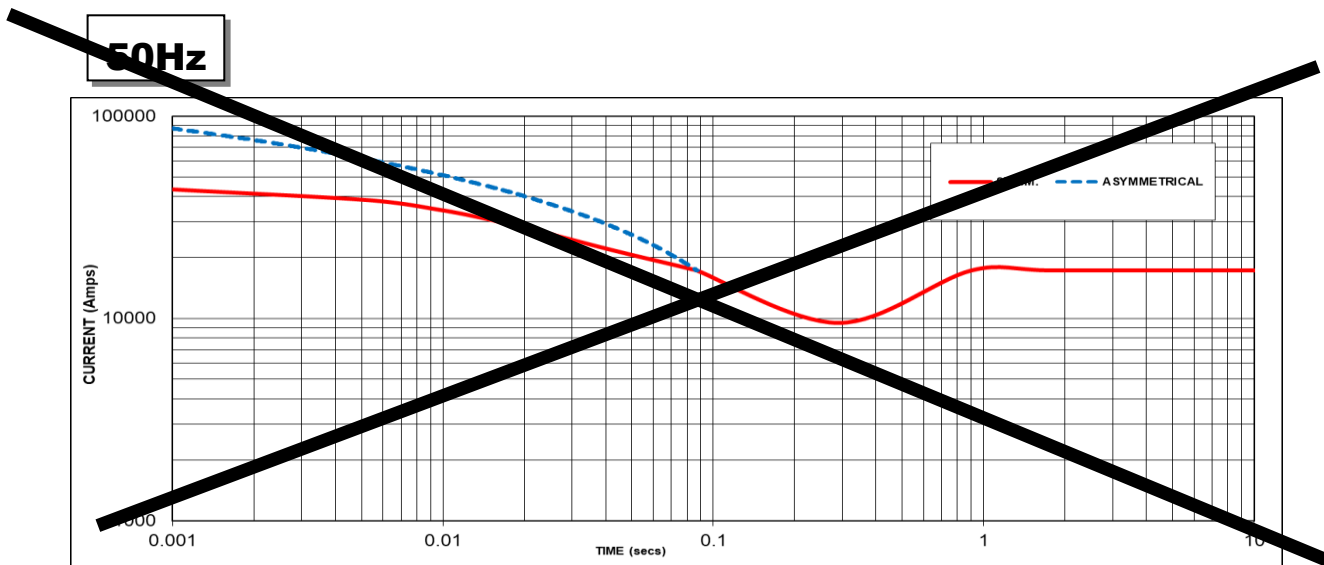

Note 1

The following multiplication factors should be used to adjust the values from curve between time 0.001 seconds and the minimum current point in respect of nominal operating voltage :

50Hz		60Hz	
Voltage	Factor	Voltage	Factor
380V	X 1.00	416V	X 1.00
400V	X 1.05	440V	X 1.06
415V	X 1.09	460V	X 1.11
440V	X 1.16	480V	X 1.15

The sustained current value is constant irrespective of voltage level

Note 2

The following multiplication factor should be used to convert the values calculated in accordance with NOTE 1 to those applicable to the various types of short circuit :

	3-phase	2-phase L-L	1-phase L-N
Instantaneous	x 1.00	x 0.87	x 1.30
Minimum	x 1.00	x 1.80	x 3.20
Sustained	x 1.00	x 1.50	x 2.50
Max. sustained duration	10 sec.	5 sec.	2 sec.

Note 3

All other times are unchanged

Curves are drawn for Star connections under no-load excitation at rated speeds. For other connection (where applicable) the following multipliers should be applied to current values as shown :

Parallel Star = Curve current value X 2

Series Delta = Curve current value X 1.732

STAMFORD

S9L1D-E4 Wdg.312

Typical Alternator Operating Charts

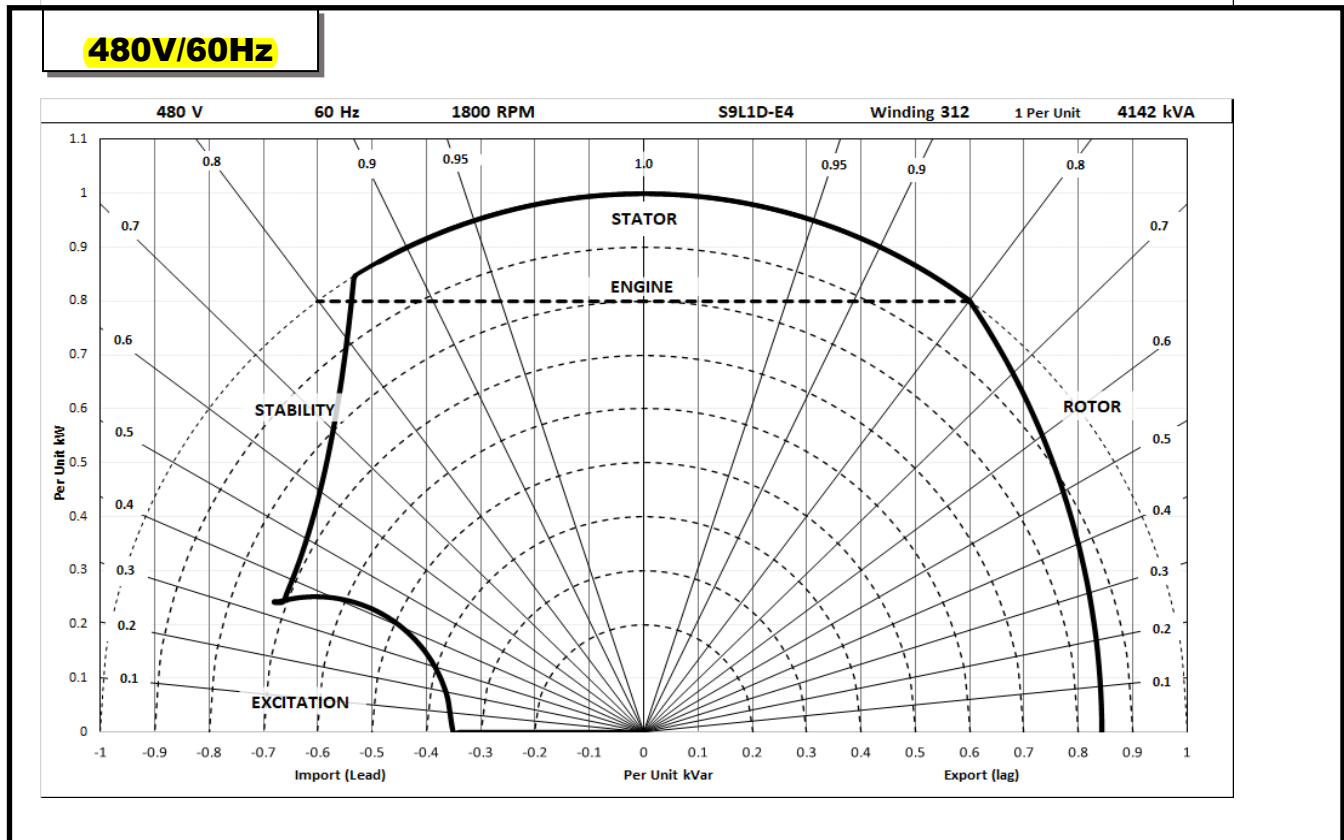
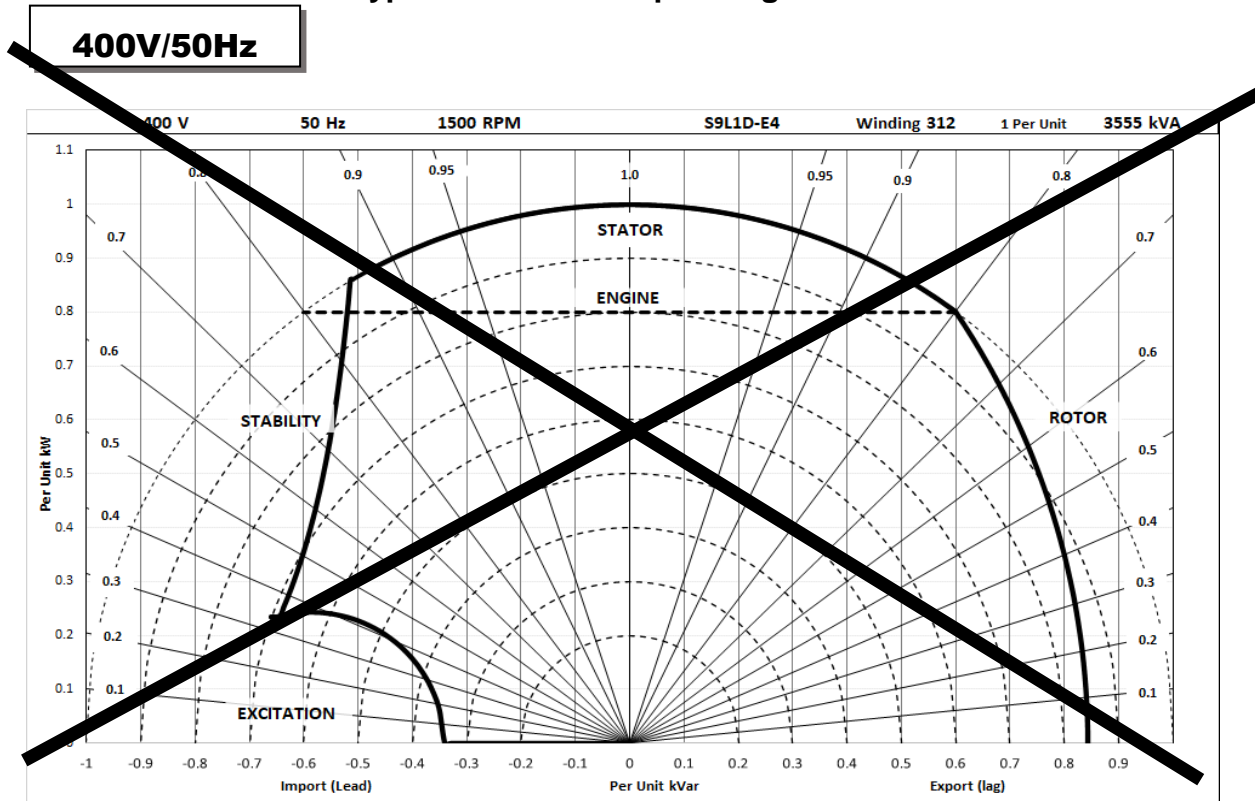

STAMFORD®

S9L1D-E4 Wdg.312

RATINGS AT 0.8 POWER FACTOR

Class - Temp Rise		Standby - 150/40°C				Cont. H - 125/40°C				Cont. F - 105/40°C				Cont. B - 80/40°C			
50 Hz	Star (V)	380	400	415	440	380	400	415	440	380	400	415	440	380	400	415	440
	Parallel Star (V)	N/A	N/A	N/A	N/A	N/A	N/A	N/A	N/A	N/A	N/A	N/A	N/A	N/A	N/A	N/A	N/A
	Delta (V)	N/A	N/A	N/A	N/A	N/A	N/A	N/A	N/A	N/A	N/A	N/A	N/A	N/A	N/A	N/A	N/A
	kVA	3610	3800	3800	3570	3375	3555	3555	3340	3155	3322	3322	3122	2740	2887	2887	2715
	kW	2888	3040	3040	2856	2700	2844	2844	2672	2524	2658	2658	2498	2192	2310	2310	2172
	Efficiency (%)	96.4	96.4	96.5	96.7	96.6	96.6	96.6	96.8	96.7	96.7	96.8	96.9	96.8	96.9	96.9	97.0
	kW Input	2995	3152	3150	2952	2796	2945	2943	2760	2611	2749	2747	2578	2264	2385	2384	2240

60 Hz	Star (V)	416	440	460	480	416	440	460	480	416	440	460	480	416	440	460	480
	Parallel Star (V)	N/A	N/A	N/A	N/A	N/A	N/A	N/A	N/A	N/A	N/A	N/A	N/A	N/A	N/A	N/A	N/A
	Delta (V)	N/A	N/A	N/A	N/A	N/A	N/A	N/A	N/A	N/A	N/A	N/A	N/A	N/A	N/A	N/A	N/A
	kVA	3840	4060	4245	4430	3590	3800	3969	4142	3350	3550	3710	3871	2915	3085	3224	3364
	kW	3072	3248	3396	3544	2872	3040	3175	3314	2680	2840	2968	3097	2332	2468	2579	2691
	Efficiency (%)	96.4	96.5	96.5	96.6	96.5	96.6	96.6	96.7	96.6	96.7	96.7	96.7	96.7	96.7	96.8	96.8
	kW Input	3186	3366	3518	3670	2975	3147	3286	3428	2775	2938	3069	3201	2413	2551	2665	2780

De-rates

All values tabulated above are subject to the following reductions:

- 5% when air inlet filters are fitted
- 3% for every 500 meters by which the operating altitude exceeds 1000 meters above mean sea level
- 3% for every 5°C by which the operational ambient temperature exceeds 40°C @ Class H temperature rise (please refer to applications for ambient temperature de-rates at other temperature rise classes)
- For marine alternators, 3% for every 5°C by which the operational ambient temperature exceeds 50°C
- For any other operating conditions impacting the cooling circuit please refer to applications

Note: Requirement for operating in an ambient exceeding 60°C and altitude exceeding 4000 meters (for <690V) or 1500 meters (for >690V) must be referred to applications.

Dimensional and Torsional Drawing

For dimensional and torsional information please refer to the alternator General Arrangement and rotor drawings available on our website (<http://stamford-avk.com/>)

Note: Continuous development of our products means that the information contained in our data sheets can change without notice, and specifications should always be confirmed with Cummins Generator Technologies prior to purchase.

Section 3 – Generator Drawings

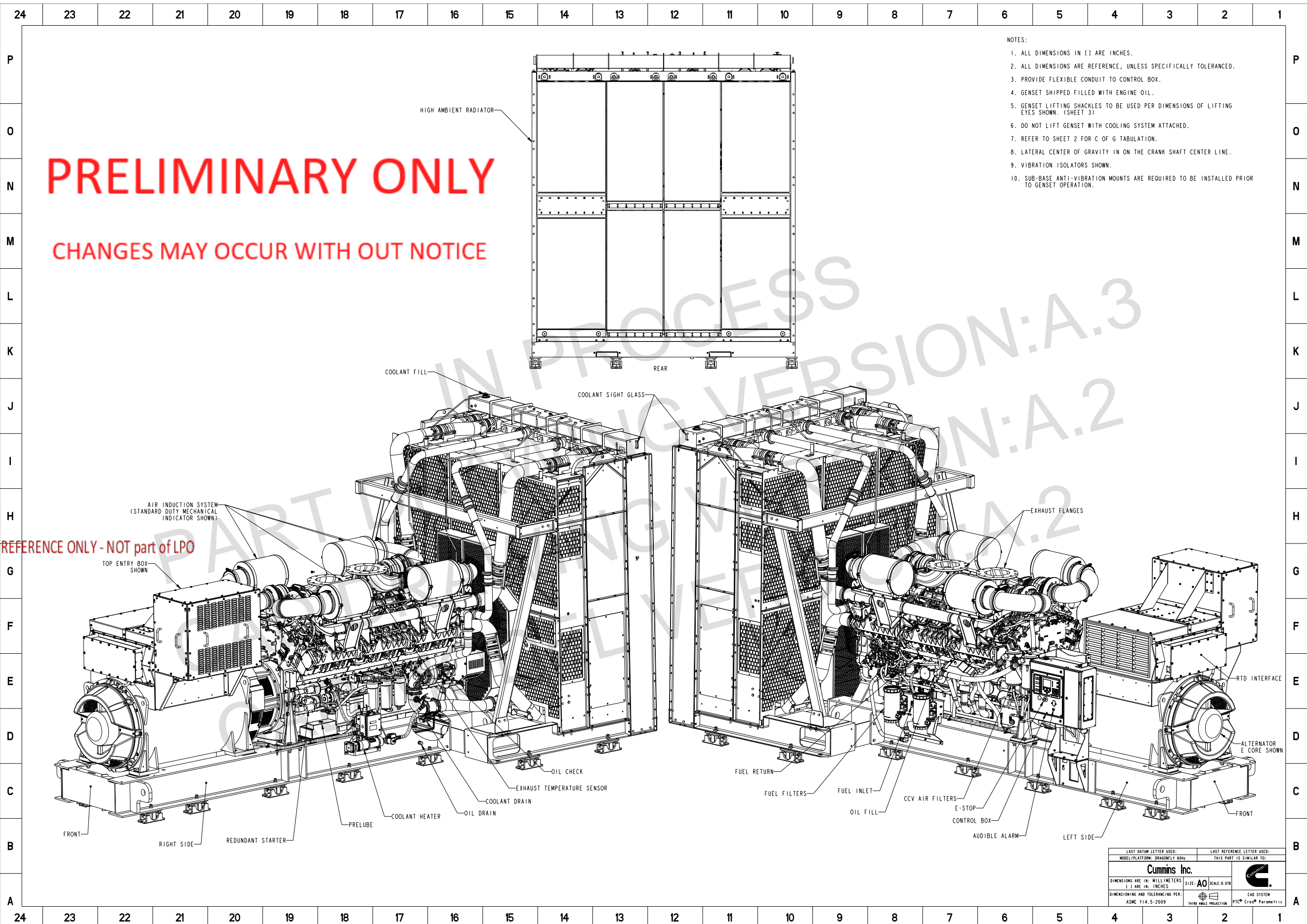

Entrance Box shown for REFERENCE ONLY - NOT part of LPO

PRELIMINARY ONLY

CHANGES MAY OCCUR WITH OUT NOTICE

GENERATOR DESIGNATION	DIM."A"	NO COOLING SYSTEM						WITH COOLING SYSTEM									
		GENSET WEIGHT (DRY)		DIM."B" CENTER OF GRAVITY	DIM."C" CENTER OF GRAVITY	GENSET WEIGHT (WET)		DIM."B" CENTER OF GRAVITY	DIM."C" CENTER OF GRAVITY	GENSET WEIGHT (WET)		DIM."B" CENTER OF GRAVITY	DIM."C" CENTER OF GRAVITY				
		KGS	LBS			KGS	LBS			KGS	LBS						
S9LID-E42	537 [21.1]	19727	43491	416 [16.4]	3166 [124.6]	20239	44619	420 [16.5]	3195 [125.8]	23644	52126	494 [19.4]	3763 [148.1]	24451	53905	500 [19.7]	3810 [150]

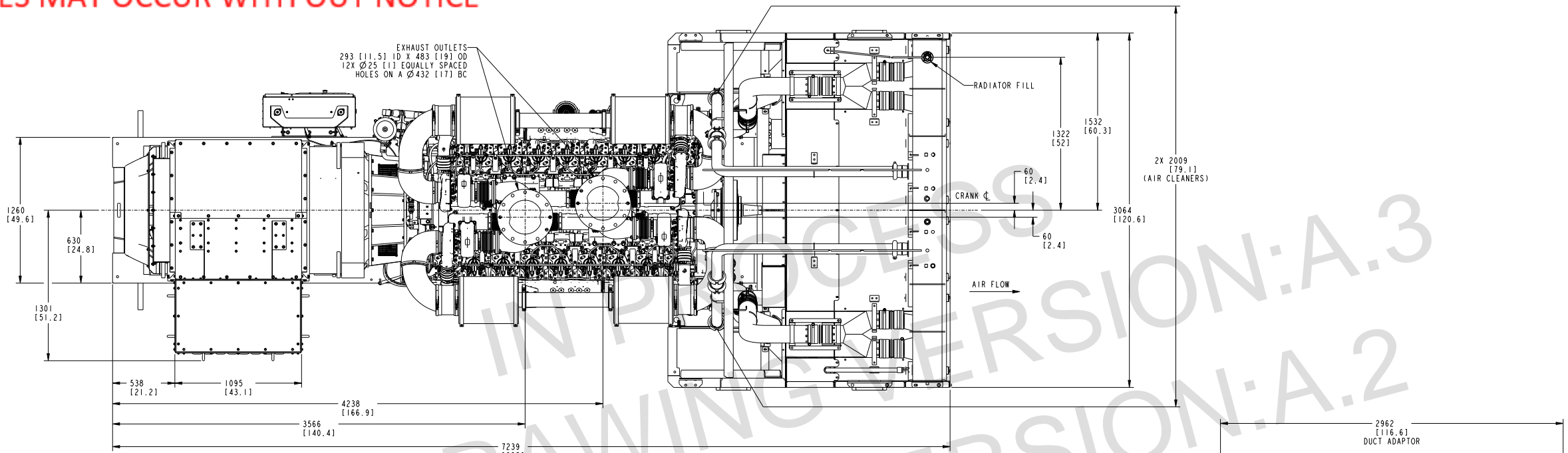

Entrance Box shown for REFERENCE ONLY - NOT part of LPO

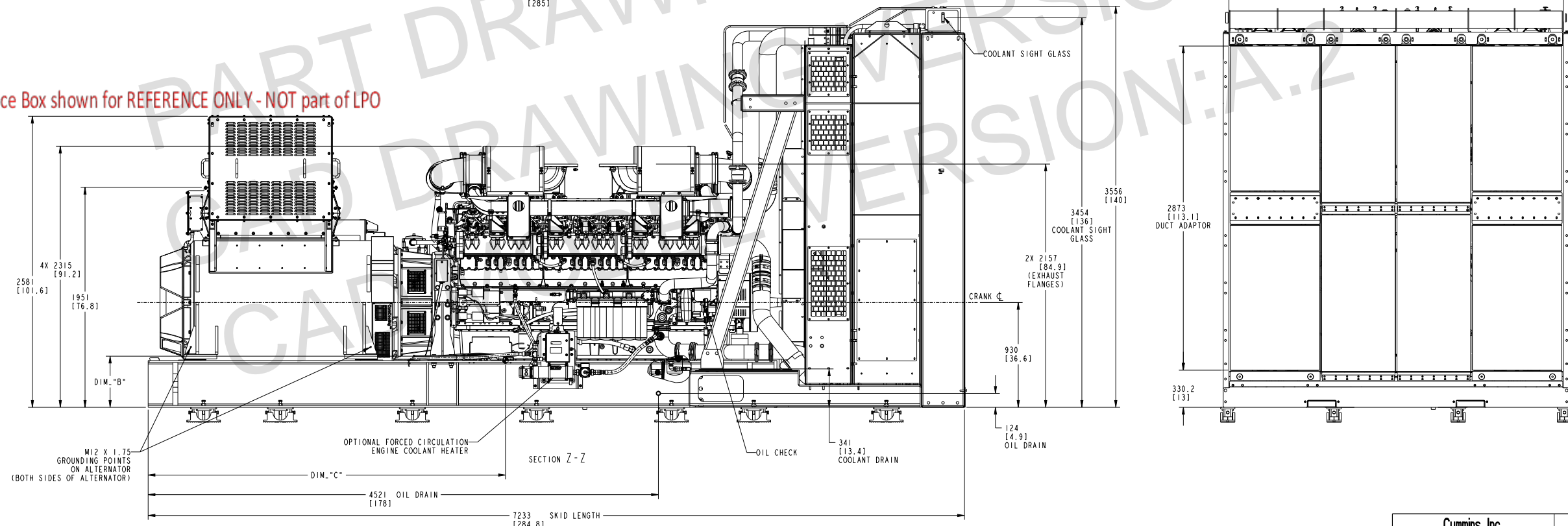

Cummins Inc.		
<small>DIMENSIONS ARE IN: MILLIMETERS</small> <small>() ARE IN: INCHES</small>	<small>SIZE: A0</small> <small>SCALE: 1:10</small>	
<small>DIMENSIONING AND TOLERANCING PER:</small> <small>ASME Y14.5-2009</small>	<small>THIRD ANGLE PROJECTION</small>	<small>CAD SYSTEM</small> <small>PTC® Creo® Parametric</small>

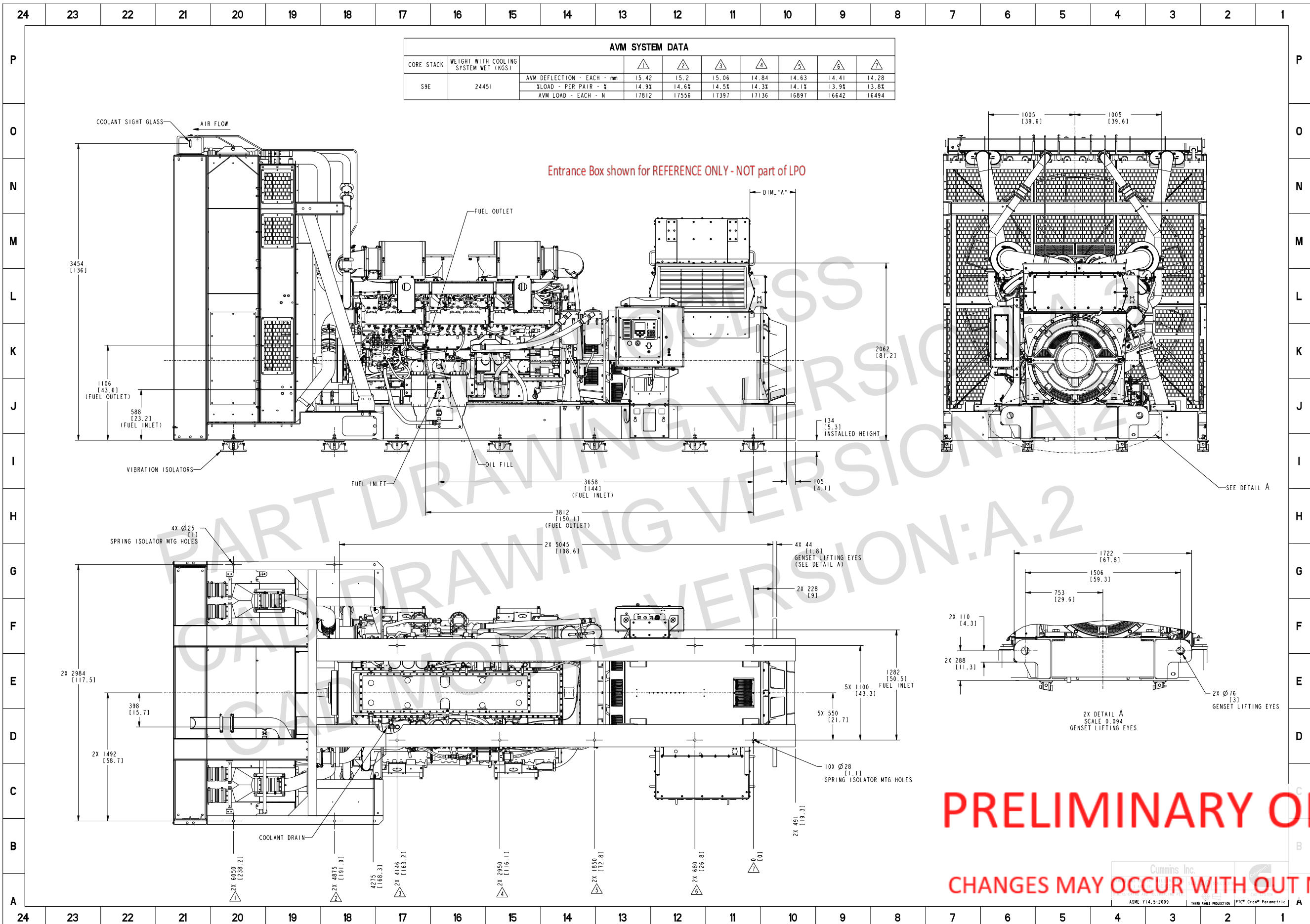

AVM SYSTEM DATA									
CORE STACK	WEIGHT WITH COOLING SYSTEM WET (KGS)	AVM DEFLECTION - EACH - mm	△1	△2	△3	△4	△5	△6	△7
S9E	24451	XLOAD - PER PAIR - %	14.9%	14.6%	14.5%	14.3%	14.1%	13.9%	13.8%
		AVM LOAD - EACH - N	17812	17556	17397	17136	16897	16642	16494

Entrance Box shown for REFERENCE ONLY - NOT part of LPO

PRELIMINARY ONLY

CHANGES MAY OCCUR WITH OUT NOTICE

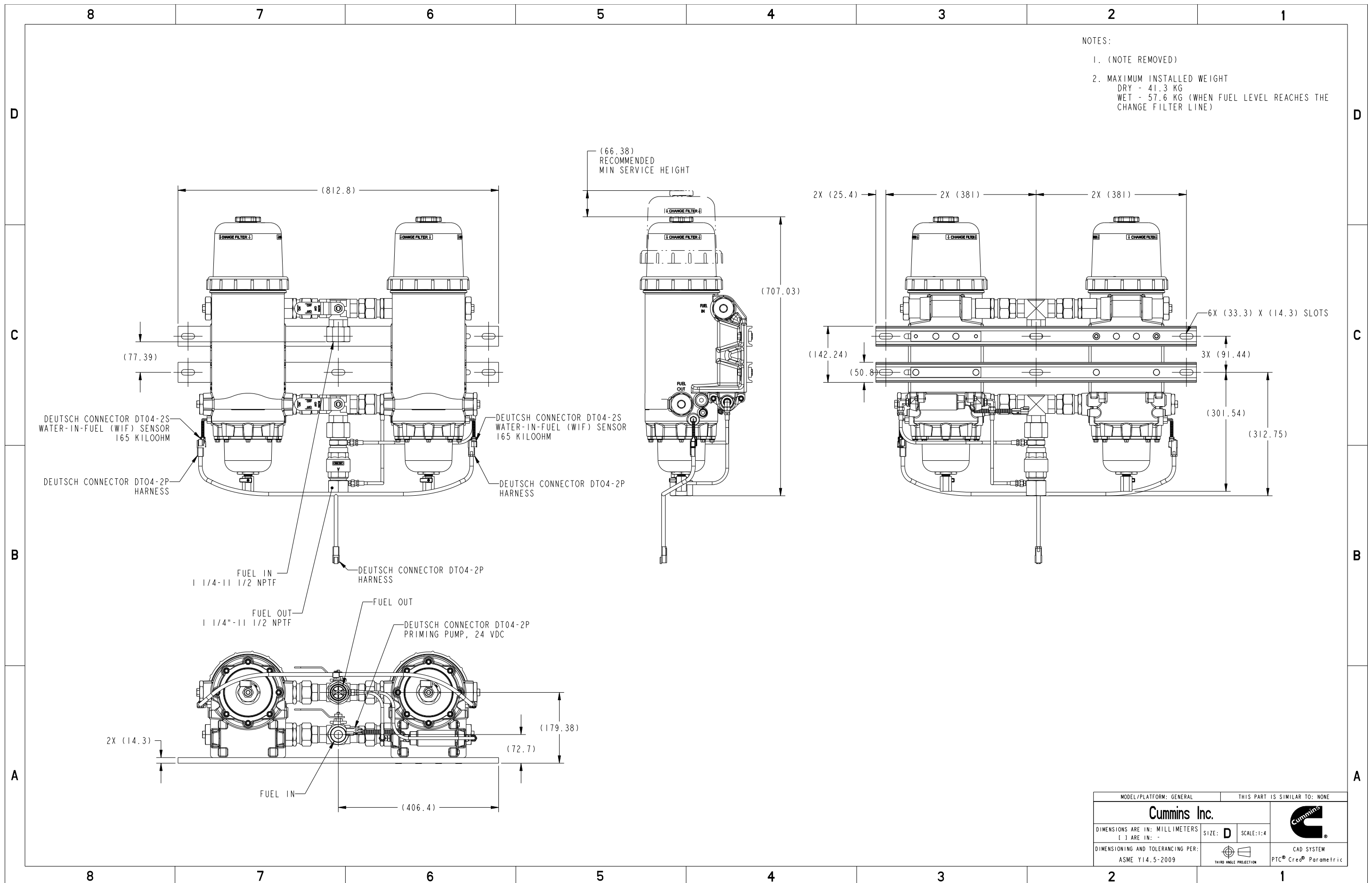

Document Generated: 02MAR2021 20:34 GMT

Cummins Data Classification:
Cummins Confidential

This document (and the information shown thereon) is **Confidential and Proprietary** and shall not be disclosed to others in hard copy or electronic form, reproduced by any means, or used for any purpose without written consent of Cummins Inc.

Part Number: **A055Y798** Part Revision: **B**

Part Name: **FILTER,FUEL**

Drawing Category: **Detail** State: **Released** Sheet 1 of 2

Section 4 – Warranty



Warranty Statement

Generator Sets

Commercial Standby Extended Warranty

Limited Standby 3 Year or 1,500 Hour Parts + Labor + Travel Extended Warranty – L188

Commercial Generating Set

When purchased, this limited extended warranty applies to all Cummins Power Generation® branded commercial generating sets and associated accessories (hereinafter referred to as "Product").

This warranty covers any failures of the Product, under normal use and service, which result from a defect in material or factory workmanship.

Warranty Period:

The warranty start date is the date of initial start up, first rental, demonstration or 18 months after factory ship date, whichever is sooner. The coverage duration is 3 years from warranty start date or 1,500 hours, whichever occurs first.

Emergency Standby Power (ESP) is defined as the maximum power available during a variable electrical power sequence, under the stated operating conditions, for which a generating set is capable of delivering in the event of a utility power outage. The permissible average power output over 24 hours of operation shall not exceed 70% of the ESP.

Cummins Power Generation® Responsibilities:

In the event of a failure of the Product during the extended warranty period due to defects in material or workmanship, Cummins Power Generation® will only be responsible for the following costs:

- All parts and labor required to repair the Product.
- Reasonable travel expenses to and from the Product site location.
- Maintenance items that are contaminated or damaged by a warrantable failure.

Owner Responsibilities:

The owner will be responsible for the following:

- Notifying Cummins Power Generation® distributor or dealer within 30 days of the discovery of failure.
- Installing, operating, commissioning and maintaining the Product in accordance with Cummins Power Generation®'s published policies and guidelines.
- Providing evidence for date of commissioning.
- Providing sufficient access to and reasonable ability to remove the Product from the installation in the event of a warrantable failure.

In addition, the owner will be responsible for:

- Incremental costs and expenses associated with Product removal and reinstallation resulting from non-standard installations.
- Costs associated with rental of generating sets used to replace the Product being repaired.
- Costs associated with labor overtime and premium shipping requested by the owner.
- All downtime expenses, fines, all applicable taxes, and other losses resulting from a warrantable failure.

Limitations:

This limited extended warranty does not cover Product failures resulting from:

- Inappropriate use relative to designated power rating.
- Inappropriate use relative to application guidelines.
- Failures due to normal wear, corrosion, varnished fuel system parts, lack of reasonable and necessary maintenance, unauthorized modifications and/or repair, and use of add-on or modified parts.
- Improper and/or unauthorized installation.
- Owner's or operator's negligence, accidents or misuse.
- Noncompliance with any Cummins Power Generation® published guideline or policy.
- Use of improper or contaminated fuels, coolants or lubricants.
- Improper storage before and after commissioning.
- Owner's delay in making Product available after notification of potential Product problem.
- Replacement parts and accessories not authorized by Cummins Power Generation®.
- Use of Battle Short Mode

Limitations Continued:

- Owner or operator abuse or neglect such as: operation without adequate coolant or lubricants; overfueling; overspeeding; lack of maintenance to lubricating, cooling or air intake systems; late servicing and maintenance; improper storage, starting, warm-up, run-in or shutdown practices, or for progressive damage resulting from a defective shutdown or warning device.
- Damage to parts, fixtures, housings, attachments and accessory items that are not part of the generating set.

This limited extended warranty does not cover costs resulting from:

- Difficulty in gaining access to the Product.
- Damage to customer property.
- Repair of cosmetic damage to enclosures.

Items not covered by this limited extended warranty:

- Batteries
- Enclosures
- Coolant heaters
- Exhaust systems and aftertreatment components
- Maintenance items

www.power.cummins.com

CUMMINS POWER GENERATION® RIGHT TO FAILED COMPONENTS:

Failed components claimed under warranty remain the property of Cummins Power Generation®. Cummins Power Generation® has the right to reclaim any failed component that has been replaced under warranty.

THE WARRANTIES SET FORTH HEREIN ARE THE SOLE WARRANTIES MADE BY CUMMINS POWER GENERATION ® IN REGARD TO THE PRODUCT. CUMMINS POWER GENERATION® MAKES NO OTHER WARRANTIES, EXPRESS OR IMPLIED, OR OF MERCHANTABILITY OR FITNESS FOR A PARTICULAR PURPOSE.

IN NO EVENT IS CUMMINS POWER GENERATION® LIABLE FOR INCIDENTAL OR CONSEQUENTIAL DAMAGES.

This limited extended warranty shall be enforced to the maximum extent permitted by applicable law. This limited extended warranty gives the owner specific rights that may vary from state to state or from jurisdiction to jurisdiction.

Product Model Number: _____

Product Serial Number: _____

Date in Service: _____

Section 5 – Interconnect Drawings

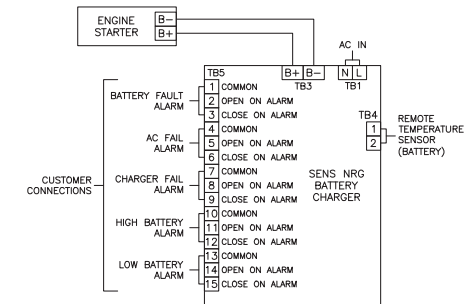
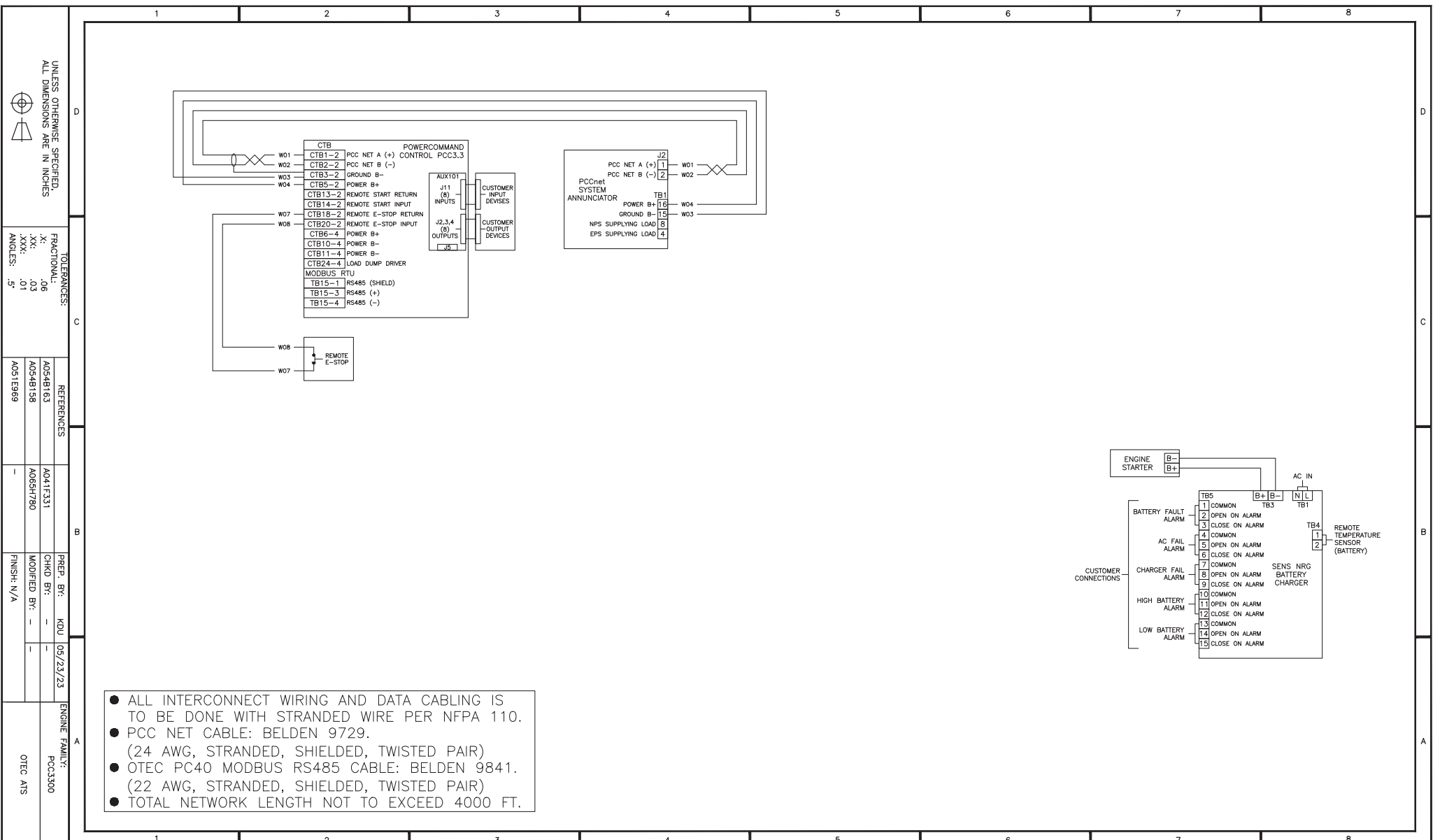

- ALL INTERCONNECT WIRING AND DATA CABLING IS TO BE DONE WITH STRANDED WIRE PER NFPA 110.
- PCC NET CABLE: BELDEN 9729. (24 AWG, STRANDED, SHIELDED, TWISTED PAIR)
- OTEC PC40 MODBUS RS485 CABLE: BELDEN 9841. (22 AWG, STRANDED, SHIELDED, TWISTED PAIR)
- TOTAL NETWORK LENGTH NOT TO EXCEED 4000 FT.

CSSNA POWER GEN	SITE NAME:	---	CONTACT NAME:	---	CUSTOMER PROJECT NO.:	---	TITLE:	PCC3.3 CONTROL / OTEC ATS QSL9L..QX15L..QSK23L..QST30L	
	CONTRACTOR NAME:	---	CONTACT NO.:	---	CSSNA PROJECT NO.:	---	SCALE:	NONE	DO NOT SCALE PRINT