

# OPERATION AND PARTS MANUAL





## **WHISPERWATT™ SERIES MODEL DCA180SSJU 60HZ GENERATOR (JOHN DEERE 6068HF485 DIESEL ENGINE)**

(PARTS LIST NO. M3870301004)

Revision #3 (02/01/10)

To find the latest revision of this  
publication, visit our website at:  
[www.mqpower.com](http://www.mqpower.com)



**WARNING**

**CALIFORNIA — Proposition 65 Warning**

Gasoline engine exhaust and some of its constituents are known to the State of California to cause cancer, birth defects and other reproductive harm.

## REPORTING SAFETY DEFECTS

---

If you believe that your vehicle has a defect that could cause a crash or could cause injury or death, you should immediately inform the National Highway Traffic Safety Administration (NHTSA) in addition to notifying Multiquip at 1-800-421-1244.

If NHTSA receives similar complaints, it may open an investigation, and if it finds that a safety defect exists in a group of vehicles, it may order a recall and remedy campaign. However, NHTSA cannot become involved in individual problems between you, your dealer, or Multiquip.

To contact NHTSA, you may either call the Vehicle Safety Hotline toll-free at 1-888-327-4236 (TTY: 1-800-424-9153), go to <http://www.nhtsa.dot.gov>; or write to:

Administrator  
NHTSA  
1200 New Jersey Avenue S.E.  
Washington, DC 20590

You can also obtain information about motor vehicle safety from  
<http://www.safecar.gov>.

# TABLE OF CONTENTS

## **MQ POWER DCA-180SSJU WHISPERWATT™ GENERATOR**

Proposition 65 Warning .....	2
Reporting Safety Defects .....	3
Table Of Contents .....	4
Parts Ordering Procedures .....	5
Specifications .....	6
Dimensions (Top, Side And Front) .....	7
Safety Message Alert Symbols .....	8-9
Rules For Safe Operation .....	10-13
Generator Decals .....	14-15
Installation .....	16-17
General Information .....	18
Major Components .....	19
Diagnostic Display .....	20-36
Generator Control Panel .....	37
Engine Operating Panel .....	38-39
Output Terminal Panel Familiarization .....	40-42
Load Application .....	43
Generator Outputs .....	44-45
Gauge Reading .....	45
Output Terminal Panel Connections .....	46-47
Setup .....	48-51
Generator Start-Up Procedure (Manual) .....	52-54
Generator Start-Up Procedure (Auto Mode) .....	55
Generator Shut-Down Procedures .....	56
Maintenance (Engine) .....	57-58
Maintenance (Heater/Charger) .....	59
Maintenance (Trailer) .....	60-63
Trailer Wiring Diagram .....	64
Generator Wiring Diagram .....	65
Engine Wiring Diagram .....	66
Troubleshooting (Generator) .....	67
Troubleshooting (Engine Controller) .....	68
Explanation Of Code In Remarks Column .....	70
Suggested Spare Parts .....	71

## **COMPONENT DRAWINGS**

Generator Assembly .....	72-73
Control Panel Assembly .....	74-75
Control Box Assembly .....	76-79
Engine And Radiator Assembly .....	80-83
Output Terminal Assembly .....	84-87
Battery Assembly .....	88-89
Muffler Assembly .....	90-91
Fuel Tank Assembly .....	92-93
Enclosure Assembly .....	94-99
Rubber Seals Assembly .....	100-101
Nameplate And Decals Assembly .....	102-103
Terms And Conditions Of Sale — Parts .....	104



# PARTS ORDERING PROCEDURES

www.mqpower.com

## Ordering parts has never been easier! Choose from three easy options:

Effective:  
January 1<sup>st</sup>, 2006



### Order via Internet (Dealers Only):

Order parts on-line using Multiquip's SmartEquip website!

- View Parts Diagrams
- Order Parts
- Print Specification Information



If you have an MQ Account, to obtain a Username and Password, E-mail us at: [parts@multiquip.com](mailto:parts@multiquip.com).

To obtain an MQ Account, contact your District Sales Manager for more information.

Goto [www.multiquip.com](http://www.multiquip.com) and click on **Order Parts** to log in and save!

Use the **internet** and qualify for a **5% Discount** on *Standard orders* for all orders which include complete part numbers.\*

Note: Discounts Are Subject To Change



### Order via Fax (Dealers Only):

All customers are welcome to order parts via Fax.

**Domestic (US) Customers dial:**  
1-800-6-PARTS-7 (800-672-7877)

**Fax** your order in and qualify for a **2% Discount** on *Standard orders* for all orders which include complete part numbers.\*

Note: Discounts Are Subject To Change



**Order via Phone: Domestic (US) Dealers Call:**  
1-800-427-1244

### Non-Dealer Customers:

Contact your local Multiquip Dealer for parts or call 800-427-1244 for help in locating a dealer near you.



**International Customers** should contact their local Multiquip Representatives for Parts Ordering information.

## When ordering parts, please supply:

- |   |  |
|---|--|
| <input type="checkbox"/> Dealer Account Number                                | <input type="checkbox"/> Specify Preferred Method of Shipment:                         |
| <input type="checkbox"/> Dealer Name and Address                              | <input checked="" type="checkbox"/> UPS/Fed Ex <input checked="" type="checkbox"/> DHL |
| <input type="checkbox"/> Shipping Address (if different than billing address) | <input type="checkbox"/> Priority One <input checked="" type="checkbox"/> Truck        |
| <input type="checkbox"/> Return Fax Number                                    | <input type="checkbox"/> Ground  |
| <input type="checkbox"/> Applicable Model Number                              | <input type="checkbox"/> Next Day  |
| <input type="checkbox"/> Quantity, Part Number and Description of Each Part   | <input type="checkbox"/> Second/Third Day  |

### NOTICE

All orders are treated as *Standard Orders* and will ship the same day if received prior to 3PM PST.

WE ACCEPT ALL MAJOR CREDIT CARDS!



# SPECIFICATIONS

Table 1. Generator Specifications		
<b>Model</b>	<b>DCA-180SSJU</b>	
<b>Type</b>	Revolving field, self ventilated, open protected type synchronous generator	
<b>Armature Connection</b>	Star with Nutreal	
<b>Phase</b>	3	
<b>Standby Output</b>	198 KVA (158 KW)	
<b>Prime Output</b>	180 KVA (144 KW)	
<b>Voltage</b>	240V or 480V	
<b>Frequency</b>	60 Hz	
<b>Speed</b>	1800 rpm	
<b>Power Factor</b>	0.8	
<b>Aux. AC Power</b>	Single Phase, 60 Hz	
<b>Voltage</b>	120 V	
<b>Output</b>	4.8 KW (2.4 KW x 2)	
<b>Weight (No Fuel)</b>	6,571 lbs. (2,980 kg.)	
<b>Weight (With Fuel)</b>	7,489 lbs. (3,400 kg.)	
Engine Specifications		
<b>Model</b>	<b>JOHN DEERE 6068HF485</b>	
<b>Type</b>	4 Cycle, water-cooled, direct injection, turbo-charged, air to air intercooled	
<b>No. of Cylinders</b>	6 cylinders	
<b>Bore x Stroke</b>	4.17 in. x 5 in. (106 mm x 127 mm)	
<b>Rated Output</b>	286 HP/1800 rpm	
<b>Displacement</b>	415 cu. in. (6.8 liters)	
<b>Starting</b>	Electric	
<b>Fuel Tank Capacity</b>	100 gal. (380 liters)	
<b>Coolant Capacity</b>	6.34 gal. (24 liters)	
<b>Lube Oil Capacity</b>	8.69 gal. (32.9 liters)	
<b>Fuel Consumption</b>	11.4 gal. (43 L)/hr at <b>full load</b>	9.0 gal. (34.1 L)/hr at <b>3/4 load</b>
	6.6 gal. (25.1 L)/hr at <b>1/2 load</b>	4.3 gal. (16.2 L)/hr at <b>1/4 load</b>
<b>Battery</b>	12V 128 Ah	
<b>Fuel</b>	#2 Diesel Fuel	

# DIMENSIONS (TOP, SIDE AND FRONT)

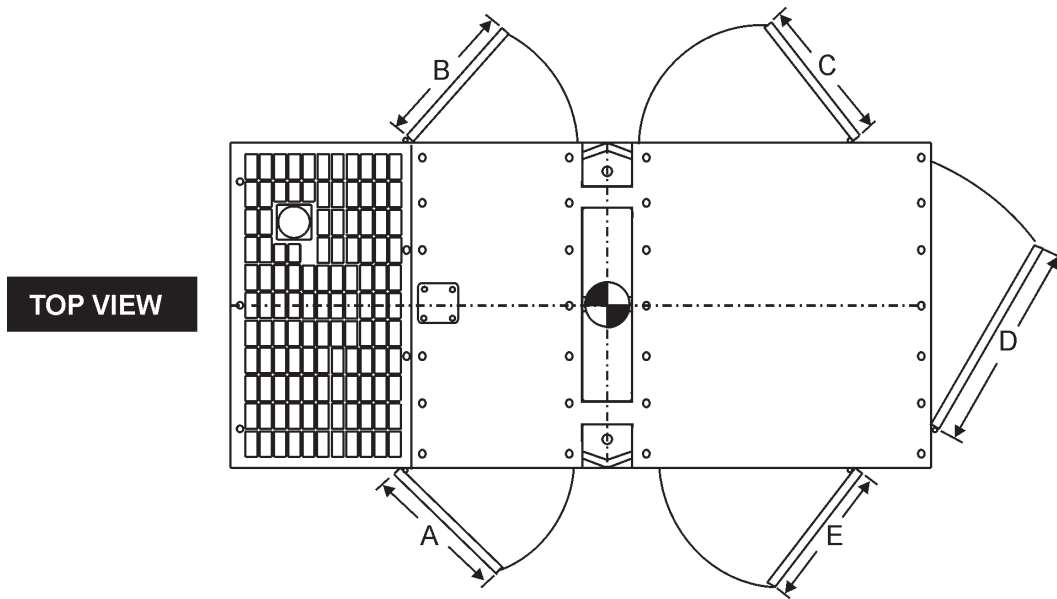

Figure 1. Dimensions

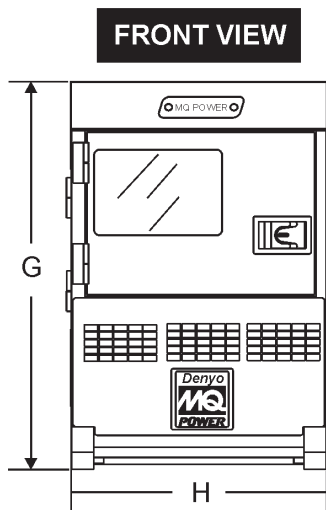
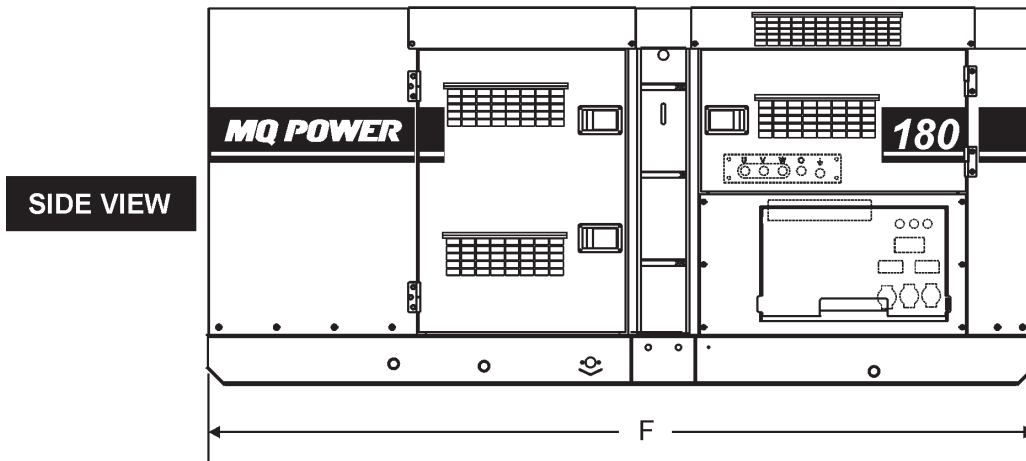
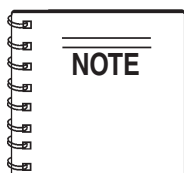

TABLE 3. DIMENSIONS			
Reference Letter	Dimension ft. (mm.)	Reference Letter	Dimension ft. (mm.)
A	37.00 in. (940 mm.)	F	137.80 in. (3,500 mm.)
B	37.00 in. (940 mm.)	G	67.00 in. (1,700 mm.)
C	41.33 in. (1,050 mm.)	H	48.80 in. (1,240 mm.)
D	41.33 in. (1,050 mm.)		
E	41.33 in. (1,050 mm.)		

# SAFETY MESSAGE ALERT SYMBOLS

## FOR YOUR SAFETY AND THE SAFETY OF OTHERS!

Safety precautions should be followed at all times when operating this equipment. Failure to read and understand the Safety Messages and Operating Instructions could result in injury to yourself and others.



This Owner's Manual has been developed to provide complete instructions for the safe and efficient operation of the MQ Power

**Before using this generator, ensure that the operating individual has read and understands all instructions in this manual.**

## SAFETY MESSAGE ALERT SYMBOLS

The three (3) Safety Messages shown below will inform you about potential hazards that could injure you or others. The Safety Messages specifically address the level of exposure to the operator, and are preceded by one of three words: **DANGER**, **WARNING**, or **CAUTION**.

### **DANGER**

You **WILL** be **KILLED** or **SERIOUSLY** injured if you do not follow directions.

### **WARNING**

You **COULD** be **KILLED** or **SERIOUSLY** injured if you do not follow directions.

### **CAUTION**

You **CAN** be injured if you do not follow directions

## HAZARD SYMBOLS

Potential hazards associated with the operation of this equipment will be referenced with " " which appear throughout this manual, and will be referenced in conjunction with Safety " " .

### **WARNING - LETHAL EXHAUST GASES**



Gasoline engine exhaust gases contain poisonous carbon monoxide. This gas is colorless and odorless, and can cause if inhaled. **NEVER** operate this equipment in a confined area or enclosed structure that does not provide ample free flow air.

### **WARNING - EXPLOSIVE FUEL**



is extremely flammable, and its vapors can cause an explosion if ignited. **DO NOT** start the engine near spilled fuel or combustible fluids. **DO NOT** fill the fuel tank while the engine is running or hot.

**DO NOT** overfill tank, since spilled fuel could ignite if it comes into contact with hot engine parts or sparks from the ignition system. Store fuel in approved containers, in well-ventilated areas and away from sparks and flames. **NEVER** use fuel as a cleaning agent.

### **WARNING - BURN HAZARDS**



Engine components can generate extreme heat. To prevent burns, **DO NOT** touch these areas while the engine is running or immediately after operations. **NEVER** operate the engine with heat shields or heat guards removed.

### **DANGER - ELECTROCUTION HAZARDS**

During operation of this generator, there exists the possibility of which can cause or even





# SAFETY MESSAGE ALERT SYMBOLS

**! WARNING - ROTATING PARTS**



**NEVER** operate equipment with covers, or guards removed. Keep , and clothing away from all moving parts to prevent injury.

**! CAUTION - RESPIRATORY HAZARDS**



**ALWAYS** wear approved protection.

**! CAUTION - ACCIDENTAL STARTING**



**ALWAYS** place the **MPEC** control switch in the **OFF/RESET** position when the generator is not in use.

**! CAUTION - SIGHT AND HEARING HAZARDS**



**ALWAYS** wear approved and protection.

**! CAUTION - OVER-SPEED CONDITIONS**



**NEVER** tamper with the factory settings of the engine governor or settings. Personal injury and damage to the engine or equipment can result if operating in speed ranges above maximum allowable.

**! CAUTION - EQUIPMENT DAMAGE MESSAGES**

Other important messages are provided throughout this manual to help prevent damage to your generator, other property, or the surrounding environment.

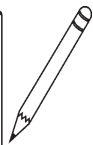
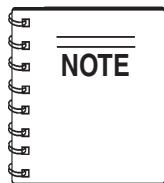

This generator, other property, or the surrounding environment could be damaged if you do not follow instructions.

# RULES FOR SAFE OPERATION

## DANGER - READ THIS MANUAL!

Failure to follow instructions in this manual may lead to or even ! This equipment is to be operated by trained and qualified personnel only! This equipment is for industrial use only.

The following safety guidelines should always be used when operating the

### General Safety:

- **DO NOT** operate or service this equipment before reading this entire manual.



The operator **MUST BE** familiar with proper safety precautions and operations techniques before using generator.

- This equipment should not be operated by persons under 18 years of age.
- **NEVER** operate this equipment without proper protective clothing, shatterproof glasses, steel-toed boots and other



protective devices required by the job.

- **NEVER** operate this equipment when not feeling well due to fatigue, illness or taking medicine.
- **NEVER** operate this equipment under the influence or drugs or alcohol.



- **NEVER** use accessories or attachments, which are not recommended by MQ Power for this equipment. Damage to the equipment and/or injury to user may result.
- Manufacturer does not assume responsibility for any accident due to equipment modifications. Unauthorized equipment modification will void all warranties.
- Whenever necessary, replace nameplate, operation and safety decals when they become difficult read.

- **ALWAYS** check the machine for loosened threads or bolts before starting.
- **NEVER** operate the generator in an explosive atmosphere or near combustible materials. An explosion or fire could result causing severe
- **NEVER** touch the hot exhaust manifold, muffler or cylinder. Allow these parts to cool before servicing engine or generator.
- **High Temperatures** – Allow the engine to cool before performing service and maintenance functions. Contact with components can cause serious burns.



- The engine of this generator requires an adequate free flow of cooling air. operate the generator in any enclosed or narrow area where free flow of the air is restricted. If the air flow is restricted it will cause serious damage to the generator or engine and may cause injury to people. The generator engine gives off **DEADLY** carbon monoxide gas.

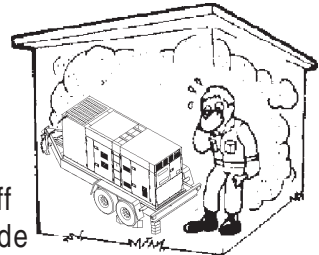

- **DO NOT** place hands or fingers inside generator engine compartment when engine is running.
- **NEVER** run engine without air filter. Severe engine damage may occur.
- **DO NOT** leave the generator running in the unattended.
- Refer to the for engine technical questions or information.
- **ALWAYS** store equipment properly when it is not being used. Equipment should be stored in a clean, dry location out of the reach of children.

# RULES FOR SAFE OPERATION

## Generator Grounding

To guard against electrical shock and possible damage to the equipment, it is important to provide a good **EARTH** ground.

Article 250 (Grounding) of the (NEC) provides guide lines for proper grounding and specifies that the cable ground shall be connected to the grounding system of the building as close to the point of cable entry as practical.

The following safety recommendations should also be followed:

- **ALWAYS** make sure generator is properly grounded.
- **NEVER** use gas piping as an electrical ground.
- **ALWAYS** make sure that electrical circuits are properly per the (NEC) and local codes before operating generator. Severe or by electrocution can result from operating an ungrounded generator.
- **ALWAYS** be sure to use the ground terminal (green wire) when connecting a load to the U,V, and W output terminal lugs.

## Electrical Safety

- **ALWAYS** have a qualified electrician perform the generator wiring installation.
- **ALWAYS** make sure generator installation is accordance with the (NEC) and local codes before operating generator.
- **NEVER** use a defective or frayed power cable. Check the cable for cuts in the insulation.
- **NEVER** use a extension cord that is frayed or damaged where the insulation has been cut.
- **ALWAYS** make certain that proper extension cord has been selected for the job. See Table 6.
- **NEVER** power cables or cords r.
- **NEVER** while AC power from the generator is being transfer to a load.

## DANGER - ELECTROCUTION HAZARDS

During operation of this generator, there exists the possibility of

which can cause or even



To avoid these hazards:

**NEVER** use damaged or worn cables when connecting equipment to the generator. Make sure power connecting cables are securely connected to the generator's output terminals, insufficient tightening of the terminal connections may cause damage to the generator and electrical shock.

**NEVER** grab or touch a live power cord with wet hands.

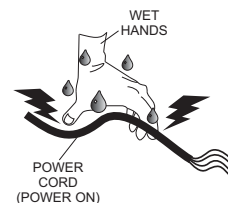

**NEVER** touch output terminals during operation. This is extremely dangerous. **ALWAYS** stop the machine and place the circuit breaker in the **OFF** position when contact with the output terminals is required.

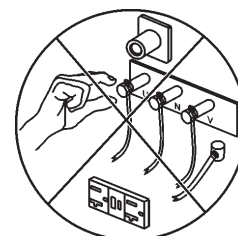

Backfeed to a utility system can cause and or property damage. **DO NOT** connect to any building's electrical system except through an approved device or after building main switch is opened. **ALWAYS** have a licensed electrician perform the installation

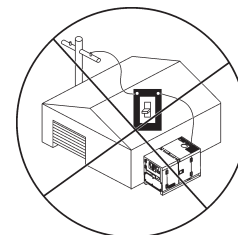

# RULES FOR SAFE OPERATION

## Maintenance Safety

- The electrical voltage required to operate the generator can cause severe injury or even death through physical contact with live circuits. Turn all circuit breakers **OFF** before performing maintenance on the generator.
- **NEVER** lubricate components or attempt service on a running machine.
- **ALWAYS** disconnect the before performing service on the generator.
- Follow all Battery Safety Guidelines listed in this manual when handling or servicing the generator.
- **ALWAYS** allow the machine a proper amount of time to cool before servicing.
- Keep the machinery in proper running condition.
- Fix damage to the machine immediately and always replace broken parts.
- **ALWAYS** service air cleaner frequently to prevent engine malfunction.

## WARNING - BURN HAZARDS

To prevent burns, **DO NOT** touch or open any of the below mentioned components while the engine is running or immediately after operations. Always allow sufficient time for the engine and generator to cool before performing maintenance.



- **Radiator Cap** - Removing the radiator cap while the engine is hot will result in high pressurized, boiling water to gush out of the radiator, causing severe scalding to any persons in the general area of the generator.
- **Coolant Drain Plug** - Removing the coolant drain plug while the engine is hot will result in hot coolant gushing out of the coolant drain plug, therefore causing severe scalding to any persons in the general area of the generator.
- **Engine Oil Drain Plug** - Removing the engine oil drain plug while the engine is hot will result in hot oil gushing out of the oil drain plug, therefore causing severe scalding to any persons in the general area of the generator.

## Battery Safety

Use the following guidelines when handling the battery:

- The battery contains acids that can cause injury to the eyes and skin. To avoid eye irritation, wear safety glasses.
- Use well insulated gloves when picking up the battery.

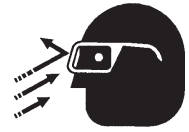

## DANGER - EXPLOSION HAZARDS

The risk of an explosion exists when performing service on the battery. To avoid or :

- **DO NOT** drop the battery. There is the possibility of risk that the battery may explode.
- **DO NOT** expose the battery to open flames, sparks, cigarettes etc. The battery contains combustible gases and liquids. If these gases and liquids come in contact with a flame or spark, an explosion could occur.

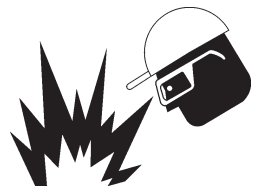

- **ALWAYS** keep the battery charged. If the battery is not charged a buildup of combustible gas will occur.
- **ALWAYS** keep battery charging and cables in good working condition. Repair or replace all worn cables.
- **ALWAYS** recharge the battery in an vented air environment, to avoid risk of a dangerous concentration of combustible gases.
- In case the battery liquid (dilute sulfuric acid) comes in contact with , rinse skin or clothing immediately with plenty of water.
- In case the battery liquid (dilute sulfuric acid) comes in contact with your , rinse eyes immediately with plenty of water and contact the nearest doctor or hospital to seek medical attention.

# RULES FOR SAFE OPERATION

## Towing & Transporting Safety

To reduce the possibility of an accident while transporting the generator on public roads, always make sure the trailer that supports the generator and the towing vehicle are in good operating condition and both units are mechanically sound.

The following list of safety precautions should be followed when towing your generator:

 **CAUTION - FOLLOW TOWING REGULATIONS**

Check with your local county or state safety towing regulations, in addition to meeting (DOT), before towing your generator.

- **ALWAYS** shutdown engine before transporting.
- Tighten both fuel tank caps securely.
- If generator is mounted on a trailer, make sure trailer complies with all local and state safety transportation laws. Follow the listed guidelines for basic towing techniques.
- Make sure the hitch and coupling of the towing vehicle are rated equal to, or greater than the trailer "gross vehicle weight rating."
- **ALWAYS** inspect the hitch and coupling for wear. **NEVER** tow a trailer with defective hitches, couplings, chains etc.
- Check the tire air pressure on both towing vehicle and trailer. Also check the tire tread wear on both vehicles.
- **ALWAYS** make sure the trailer is equipped with a "Safety Chain".
- **ALWAYS** attach trailer's safety chains to towing vehicle properly.
- **ALWAYS** make sure the vehicle and trailer directional, backup, brake, and trailer lights are connected and working properly.
- DOT Requirements include the following:
  - Connect and test electric brake operation.
  - Secure portable power cables in cable tray with tie wraps.

- The maximum speed for highway towing is **55 MPH** unless posted otherwise. Recommended off-road towing is not to exceed **15 MPH** or less depending on type of terrain.
- Place \_\_\_\_\_ underneath wheel to prevent **rolling**, while parked.
- Use the trailer's swivel jack to adjust the trailer height to a level position while parked.
- Avoid sudden stops and starts. This can cause skidding, or jack-knifing. Smooth, gradual starts and stops will improve towing.
- Avoid sharp turns.
- Trailer should be adjusted to a level position at all times when towing.
- Raise and lock trailer wheel stand in up position when transporting.
- The maximum speed for highway towing is **55 MPH** unless posted otherwise. Recommended off-road towing is not to exceed **15 MPH** or less depending on type of terrain.
- Place *support blocks* underneath the trailer's bumper to prevent **tipping**, while parked.
- Avoid sharp turns to prevent rolling.
- **DO NOT** transport generator with fuel in tank.

## Emergencies

- **ALWAYS** know the location of the nearest \_\_\_\_\_.
- **ALWAYS** know the location of the nearest \_\_\_\_\_ and \_\_\_\_\_.
- **ALWAYS** know the location of the nearest phone or \_\_\_\_\_ in case of emergencies.
- **ALWAYS** have easy access to the phone numbers of the nearest \_\_\_\_\_, \_\_\_\_\_, and \_\_\_\_\_. This information will be invaluable in the case of an emergency.



# GENERATOR DECALS

The DCA-180SSJU generator is equipped with a number of safety decals (Figures 2 & 3). These decals are provided for operator safety and maintenance information. The illustration below and on the preceding page show the decals as they appear on the machine. Should any of these decals become unreadable, replacements can be obtained from your dealer.

**OPERATING PROCEDURES**

**Manual Starting**

1. Check the engine oil, coolant, and fuel levels. Replenish if necessary.
2. Place all Generator Circuit Breakers in the "OFF" position and close all doors.
3. Check that the Voltage select switch (or the Voltage change-over board) is present at desired voltage.  
(In case of generator having multiple voltage ratings.)
4. Set the Engine speed switch to the "LOW" position.
5. Turn the Auto-Off/Reset-Manual switch to the "Manual" position to start the engine. If the engine fails to start in the specified number of attempts, the overcrank lamp will indicate and the Auto-Off/Reset-Manual switch must be returned to the "Off/Reset" position before proceeding.
6. When the engine is ready for starting during cold weather operating conditions, push the water heater button for approximately 30 seconds. Start engine using the Auto-Off/Reset-Manual switch to the "Manual" position. As soon as the engine starts, release the button.  
If the engine still does not start, utilize the water heater until water is warm. (If additional water heater is supplied.)
7. After starting, allow the engine to run for 1 or 2 minutes to warm-up. At temperatures below freezing, this time period must be extended to 2 to 4 minutes.
8. When the engine starts, immediately check for abnormal noise, vibration, fluid leakage or any indication of a problem. Check the control panel gauges. If all is normal, let the engine remain at the "Low" position for a short time, depending on the ambient conditions, warm up.
9. After sufficient warm-up time has elapsed, set the Engine speed switch to the "High" position and the unit is ready for operation.
10. Check the NO-Load speed as shown in the table below.  
60Hz operation—Approx. 60.0Hz (1800rpm)
11. Adjust the Voltage Regulator to the specified voltage.

**Manual Stopping**

1. Place the Generator Circuit Breakers in the "OFF" position.
2. Set the Engine speed switch to the "LOW" position, and allow the unit to cool for a few minutes.
3. Turn the Auto-Off/Reset-Manual switch, to the "Off/Reset" position.

**Auto Starting/Stopping**

1. With the Auto/Manual switch in the Auto position, the Auto Starting/Stopping controller monitors remote start contacts. Closure of the remote start contacts will begin engine cranking. When the contacts are opened cranking will stop. If cranking the engine will stop. All functions for the Automatic shutdown System work as in Manual Starting/stopping.
2. For cold weather conditions utilize the water heater until water is warm. If the engine still does not start, please operate as in Manual Starting.

**Emergency Stopping**

1. Place the Generator Circuit Breakers in the "OFF" position.
2. Turn the Auto-Off/Reset-Manual switch to the "Off/Reset" position.

M35200010

P/N M3552000103

**SAFETY INSTRUCTIONS**

Improper operation of this machine can cause severe injury or death.

- Read the instruction manual carefully before operating or servicing. This machine should only be operated by a person with sufficient knowledge and skill to ensure safe operation. High voltage circuits are located inside the output terminal cover and control panel.
- Close the cover and control panel before operating. Moving parts and hot surfaces are contained within the enclosure.
- Close all doors and lock them before operating.

M92010030

P/N M9520100304

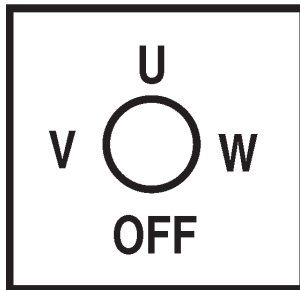

P/N M9520000104

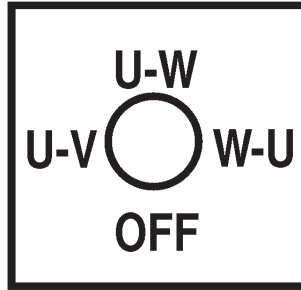

P/N M9520000204



P/N M950000004



P/N M9510200002

**OVER CURRENT RELAY**

If it is Impossible to reset the CIRCUIT BREAKER, open the control panel and push the RESET BUTTON as below.

M92020010

P/N M9520200104



P/N M9500300104



P/N M9500300004



P/N M9500500004



P/N M9503000103

Figure 2. Generator Decals



# GENERATOR DECALS

	<b>⚠ WARNING</b>	<b>⚠ WARNING</b>	<b>⚠ WARNING</b>
	<b>ELECTRIC SHOCK HAZARD</b> <ul style="list-style-type: none"> <li>Do not touch output terminals when this machine is operating.</li> <li>Turn power off before servicing</li> </ul>	<b>ELECTRIC SHOCK HAZARD</b> <ul style="list-style-type: none"> <li>Always complete the grounding path from the ground terminal on this genset to an external grounding source. See instruction manual for details.</li> </ul>	<ul style="list-style-type: none"> <li>Before connecting this generator to any building's electrical system, a licensed electrician must install an isolation (transfer) switch.</li> <li>Serious injury or death may result without this transfer switch</li> </ul>

M9520 100503

P/N M9520100503

	<b>⚠ WARNING</b>
	<b>HOT COOLANT can cause severe burns.</b> <ul style="list-style-type: none"> <li>Do not remove cap if radiator is hot.</li> </ul>

M90310000

P/N M9503100004

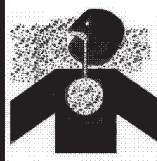
	<b>⚠ WARNING</b>
	<b>ENGINE EXHAUST can cause severe injury or death.</b> <ul style="list-style-type: none"> <li>Use only in open, well ventilated areas or vent exhaust outside.</li> </ul>

M90320000

P/N M9503200004

<b>DANGER</b>
<b>HIGH VOLTAGE</b>

M9520100401

P/N M9520100404

<b>⚠ CAUTION</b>
Stop engine before switching

M9520100204

P/N M9520100204

	<b>⚠ CAUTION</b>
	<b>MOVING PARTS can cause severe injury.</b> <ul style="list-style-type: none"> <li>Do not operate with doors open.</li> <li>Stop engine before servicing.</li> </ul>

M90300000

P/N M9503000004

<b>NOTE</b>
To use 50 amp receptacles, adjust the voltage selector switch to the single phase position and the main line circuit breaker to the on position.

P/N M1500020

P/N M1550000204

	<b>⚠ CAUTION</b>
	<ul style="list-style-type: none"> <li>HOT PARTS can burn skin.</li> <li>Do not touch until the machine has sufficiently cooled.</li> </ul>

M91010000

P/N M9510100004

	<b>⚠ WARNING</b>
	<b>ELECTRIC SHOCK HAZARD</b> <ul style="list-style-type: none"> <li>Do not touch output terminals while this machine is operating.</li> <li>Turn power off before servicing.</li> </ul>

P/N M9520100503

	<b>⚠ WARNING</b>
	<b>ELECTRIC SHOCK HAZARD</b> <ul style="list-style-type: none"> <li>Do not touch internal wiring or connections while this machine is operating.</li> <li>Turn power off before servicing.</li> </ul>

M92010000

P/N M9520100004

<b>⚠ CAUTION</b>
This machine stops and starts Automatically and without notice.

P/N B15200010

P/N B15200010

Figure 3. Generator Decals (Cont inued)

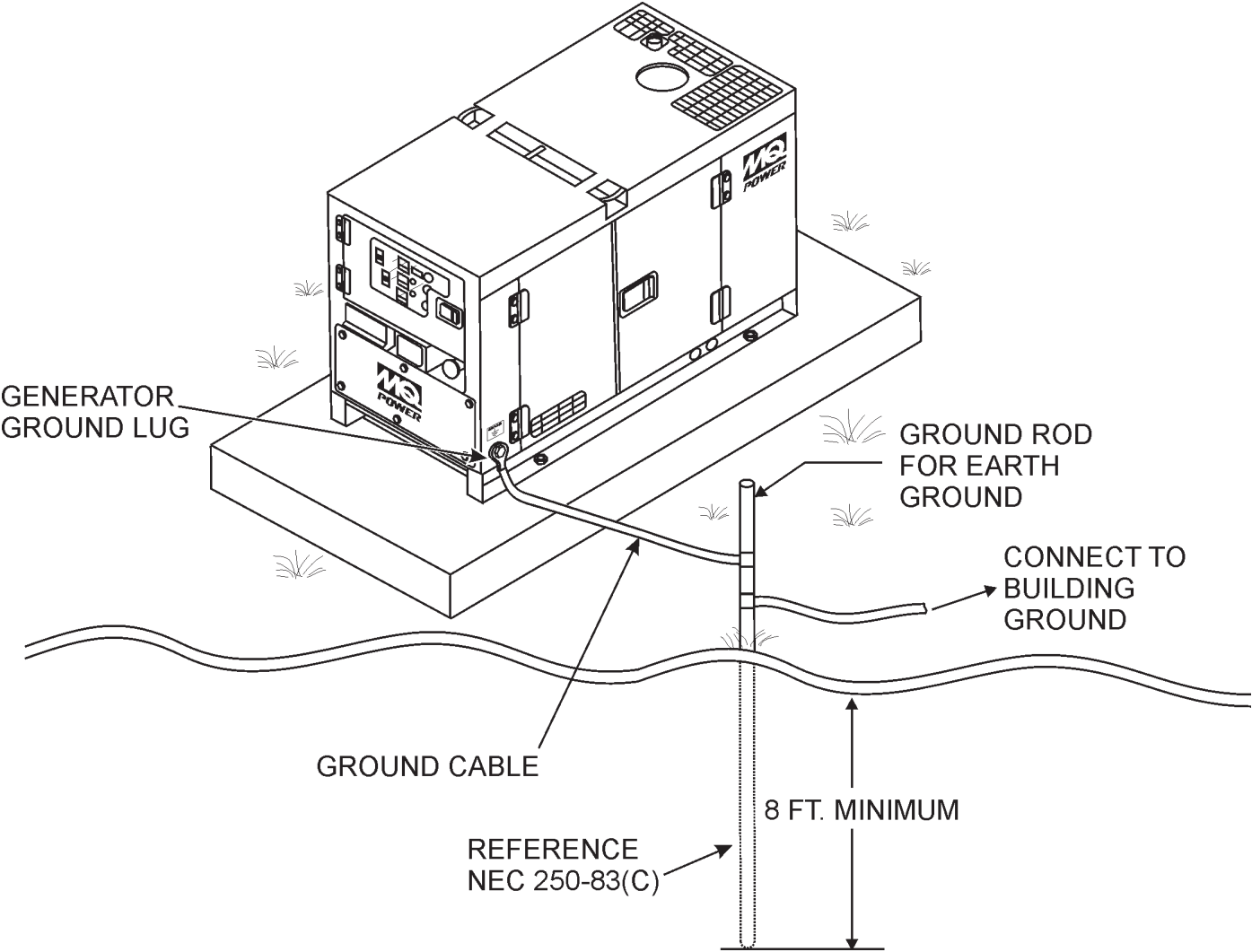

**Figure 4. Typical Generator Grounding Application**



## Outdoor Installation

Install the generator in a area that is free of debris, bystanders, and overhead obstructions. Make sure the generator is on secure level ground so that it cannot slide or shift around. Also install the generator in a manner so that the exhaust will not be discharged in the direction of nearby homes.

The installation site must be relatively free from moisture and dust. All electrical equipment should be protected from excessive moisture. Failure to do will result in deterioration of the insulation and will result in short circuits and grounding.

Foreign materials such as dust, sand, lint and abrasive materials have a tendency to cause excessive wear to engine and alternator parts.

### CAUTION - EXHAUST HAZARD

Pay close attention to ventilation when operating the generator inside tunnels and caves. The engine exhaust contains noxious elements. Engine exhaust must be routed to a ventilated area.

## Indoor Installation

Exhaust gases from diesel engines are extremely poisonous. Whenever an engine is installed indoors the exhaust fumes must be vented to the outside. The engine should be installed at least two feet from any outside wall. Using an exhaust pipe which is too long or too small can cause excessive back pressure which will cause the engine to heat excessively and possibly burn the valves.

## Mounting

The generator must be mounted on a solid foundation (such as concrete) and set firmly on the foundation to isolate vibration of the generator when it is running. The generator must set at least 6 inches above the floor or grade level (in accordance to NFPA 110, Chapter 5-4.1). **DO NOT** remove the metal skids on the bottom of the generator. They are to resist damage to the bottom of the generator and to maintain alignment.

## Generator Grounding

To guard against electrical shock and possible damage to the equipment, it is important to provide a good **EARTH** ground.

Article 250 (Grounding) of the National Electrical Code (NEC) provides guide lines for proper grounding and specifies that the cable ground shall be connected to the grounding system of the building as close to the point of cable entry as practical.

NEC articles 250-64(b) and 250-66 set the following grounding requirements:

1. Use one of the following wire types to connect the generator to earth ground.
  - a. Copper - 10 AWG (5.3 mm<sup>2</sup>) or larger.
  - b. Aluminum - 8 AWG (8.4 mm<sup>2</sup>) or larger.
2. When grounding the generator (Figure 4) connect the ground cable between the lock washer and the nut on the generator and tighten the nut fully. Connect the other end of the ground cable to earth ground.
3. NEC article 250-52(c) specifies that the earth ground rod should be buried a minimum of 8 ft. into the ground.

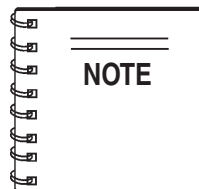

When connecting the generator to any buildings electrical system **ALWAYS** consult with a licensed electrician.

## DCA-180SSJU Whisperwatt™ Series Familiarization

### Generator

The MQ Power Model DCA-180SSJU is a 180 kW (Figure 5) that is designed as a high quality portable (requires a trailer for transport) power source for telecom sites, lighting facilities, power tools, submersible pumps and other industrial and construction machinery.

### Engine Operating Panel

The "Engine Operating Panel" is provided with the following:

- Tachometer
- Water Temperature Gauge
- Oil Pressure Gauge
- Charging Ammeter Gauge
- Fuel Level Gauge
- Engine Speed Switch
- Auto ON/OFF Engine Controller (MPEC)
- Preheat Lamp
- Warning Lamp
- Emergency Stop Lamp
- Emergency Stop Button
- Diagnostic Gauge
- Panel Light/Panel Light Switch

### Generator Control Panel

The "Generator Control Panel" is provided with the following:

- Frequency Meter (Hz)
- AC Ammeter (Amps)
- AC Voltmeter (Volts)
- Ammeter Change-Over Switch
- Voltmeter Change-Over Switch
- Voltage Regulator
- 3-Pole, 500 amp Main Circuit Breaker
- "Control Box" (located behind the Gen. Control Panel)
  - Automatic Voltage Regulator
  - Diagnostic Display
  - Current Transformer
  - Over-Current Relay
  - Voltage Rectifier
  - Starter Relay
  - Engine Controller (Computer Controlled)
  - Voltage Change-over Board

### Output Terminal Panel

The "Output Terminal Panel" is provided with the following:

- Three 120/240V output receptacles (CS-6369), 50A
- Three auxilliary circuit breakers, 50A
- Two 120V output receptacles (GFCI), 20A
- Two GFCI circuit breakers, 20A
- Five output terminal lugs (3Ø power)
- Battery Charger (Optional)
- Water Heater (Optional)

### Open Delta Excitation System

The DCA-180SSJU generator is equipped with the state of the art " " excitation system. The open delta system consist of an electrically independent winding wound among stationary windings of the AC output section.

There are four connections of the open delta A, B, C and D. During steady state loads, the power from the voltage regulator is supplied from the parallel connections of A to B, A to D, and C to D. These three phases of the voltage input to the voltage regulator are then rectified and are the excitation current for the exciter section.

When a heavy load, such as a motor starting or a short circuit occurs, the automatic voltage regulator (AVR) switches the configuration of the open delta to the series connection of B to C. This has the effect of adding the voltages of each phase to provide higher excitation to the exciter section and thus better voltage response during the application of heavy loads.

The connections of the AVR to the AC output windings are for sensing only. No power is required from these windings.

The open-delta design provides virtually unlimited excitation current, offering maximum motor starting capabilities. The excitation does not have a " " and responds according the demands of the required load.

### Engine

The **DCA-180SSJU** is powered by a 6 cylinder, water cooled, direct injection, turbocharged

. This engine is designed to meet every performance requirement for the generator. Reference Table 1 for engine specifications.

In keeping with MQ Power's policy of constantly improving its products, the specifications quoted herein are subject to change without prior notice.

### Electric Governor System

The electric governor system controls the RPMs of the engine. When the engine demand increases or decreases, the governor system regulates the frequency variation to  $\pm 0.25\%$ .

### Extension Cables

When electric power is to be provided to various tools or loads at some distance from the generator, extension cords are normally used. Cables should be sized to allow for distance in length and amperage so that the voltage drop between the generator and point of use (load) is held to a minimum. Use the cable selection chart (Table 6) as a guide for selecting proper extension cable size.

# MAJOR COMPONENTS

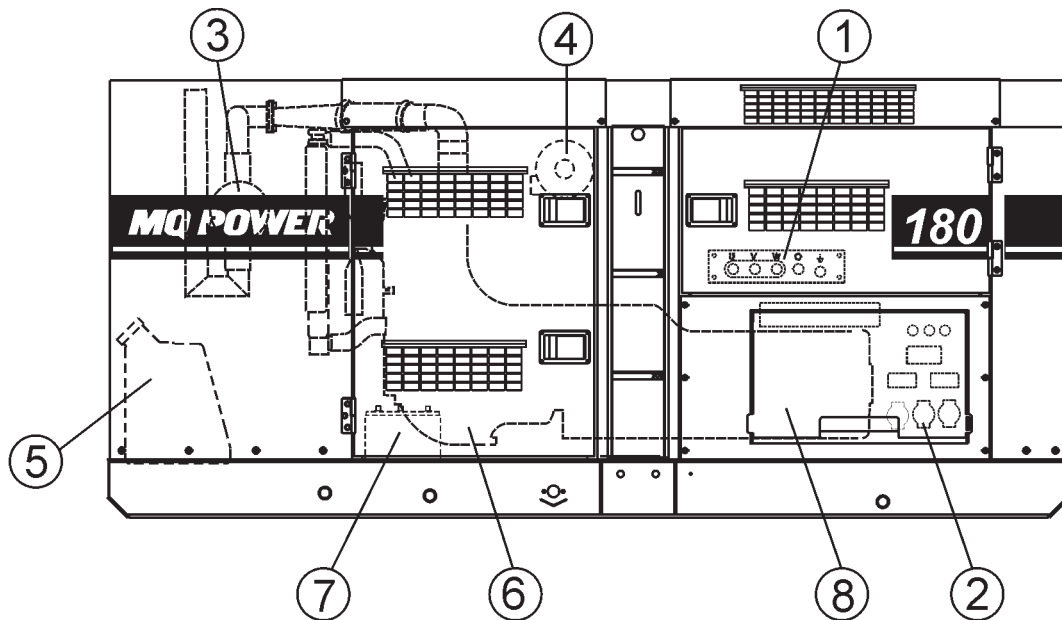

Figure 5. Major Components

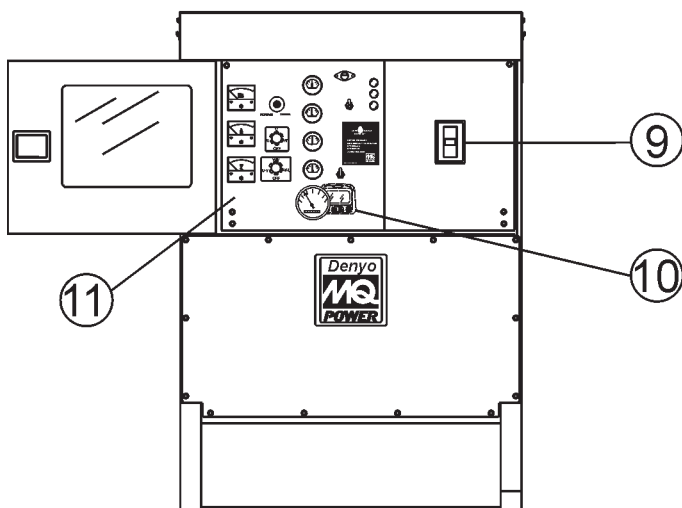

Table 4. Generator Major Components

ITEM NO.	DESCRIPTION
1	Output Terminal Panel Assembly
2	Output Receptacles Assembly
3	Air Filter Assembly
4	Muffler Assembly
5	Fuel Tank Assembly
6	Engine Assembly
7	Battery Assembly
8	Generator Assembly
9	Circuit Breaker Assembly
10	Diagnostic Display Assembly
11	Generator/Engine Control Panel Assembly

## DIAGNOSTIC DISPLAY

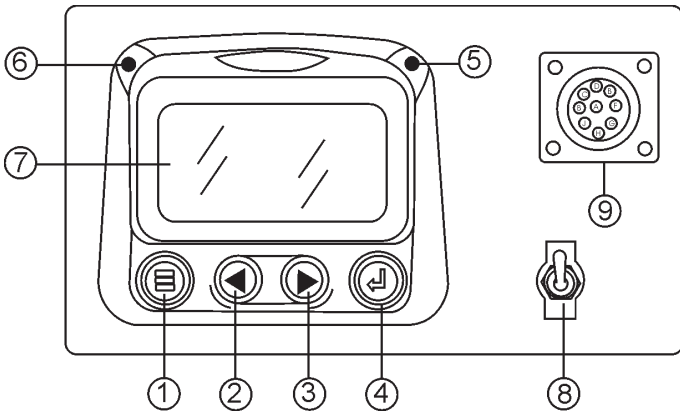

Figure 6. Diagnostic Display Panel

The diagnostic display panel located inside the control box on the generator (Figure 6) is designed to meet the needs for instrumentation and control of electronically controlled engine communication using the SAEJ1939 Controller Area Network (CAN). This diagnostic display is a multifunction tool that enables equipment operators to view many different engine parameters and service codes.

The keypad on the diagnostic display panel is a capacitive touch sensing system. There are no mechanical switches to wear or stick. This keypad (display unit) will operate in extreme hot or cold weather conditions.

Other components in the system are microprocessor-based components for displaying critical engine data broadcast by an electronic engine or transmission's Engine Control Unit (ECU): engine RPM, oil pressure, coolant temperature, system voltage, etc., and a combination audible alarm and relay unit for warning and shutdown annunciation.

The Engine Control Unit (ECU) used with this generator diagnosis engine faults that arise with the the engine control system and the engine itself. Engine faults can be determined by viewing the Diagnostic Trouble Codes (Active Fault Codes) which are displayed on the Diagnostic Display Panel. See the John Deere Engine Operator's Manual for a complete listing of active fault codes and countermeasures.

The following definitions describe the controls and functions of the (Figure 6).

1. **Menu Button** – Press this button to enter or exit menu screens.
2. **Left Arrow Button**– Press this button to scroll through the screen either moving the parameter selection toward the left or upward.

3. **Right Arrow Button** – Press this button to scroll through the screen either moving the parameter selection toward the right or downward.
4. **Enter Key Button** – Press this button to select the parameter that is highlighted on the screen.
5. **Emergency Stop LED** – When lit (**RED**) indicates a major fault has occurred. This condition will shutdown the generator.
6. **Warning LED** – When lit (**AMBER**), indicates a engine parameter has exceeded its limits (minor fault). The generator will still run in this condition.
7. **Display Screen** – Graphical backlight LCD screen. Back lighting is controlled via menu or external dimmer potentiometer. The display can show either a single parameter or a quadrant display showing four parameters simultaneously.
8. **Diagnostic Switch** – When placed in the **ON** position, will activate the diagnostic display panel.
9. **CAN Diagnostic Connector** – Controller Area Network connector. This connector outputs diagnostic error codes. Connect a scanner or similar device into this connector to read error codes.

### Display Parameters

The following are some of the engine and transmission parameters displayed on the diagnostic display panel.

- Engine RPM's
- Engine Hours
- System Voltage
- % Engine Load at current RPM
- Coolant Temperature
- Oil Pressure
- Fuel Economy
- Current Fuel Consumption
- Throttle Position
- Engine Manifold Air Temperature
- Active Service Codes
- Set Units for Display (English or Metric)
- English Configuration Parameters.

# DIAGNOSTIC DISPLAY

## First Time Start Up

1. When power is first applied to the diagnostic display, the "Logo" is displayed.



2. The "Wait to Start" message will be displayed for engines with a pre-startup sequence. Once the "Wait to Start" message is no longer displayed the operator may start the engine. Note: Displays only when SAE J1939 message is supported by engine manufacturer.



3. Once the engine has started the single engine parameter is displayed.



## Main Menu Navigation

1. Starting at the single or four engine parameter display, touch "Menu".

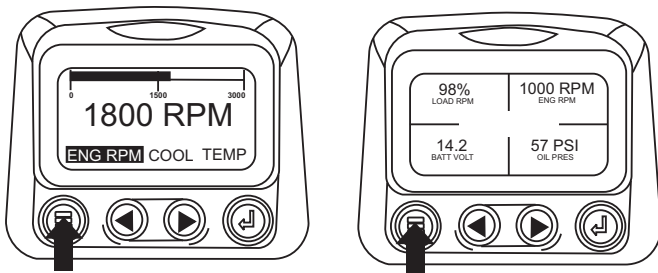

2. The first seven items of the "Main Menu" will be displayed. Touching the "Arrow Buttons" will scroll through the menu selection.

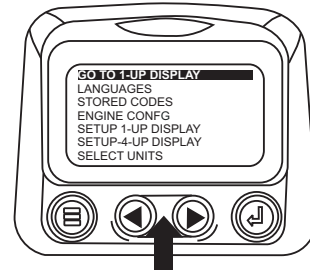

3. Touching the right arrow button will scroll down to reveal the last items of "Main Menu" screen highlighting the next item down.



4. Touch the "Arrows" to scroll to the desired menu item or touch "Menu" to exit the Main menu and return to the engine parameter display.

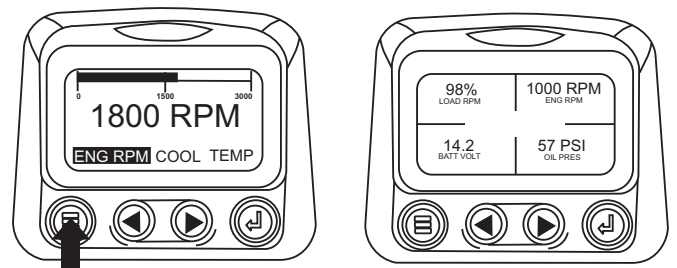

## Selecting a Language

1. Starting at the main menu display use the "Arrows" to scroll to the "Language" menu and once highlighted touch the "Enter" button.

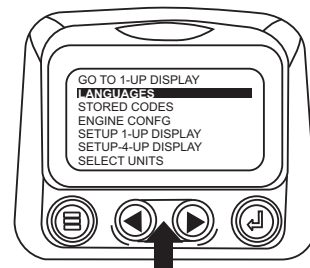



# DIAGNOSTIC DISPLAY

- The language choices will be displayed. Use the “Arrow” buttons to scroll through the selections and touch “Enter” to make a selection.



- Now that you have selected the language, touch the “Menu” button to return to the main menu display.

## Stored Fault Codes

- Starting at the single or the four engine parameter display touch the “Menu button”.

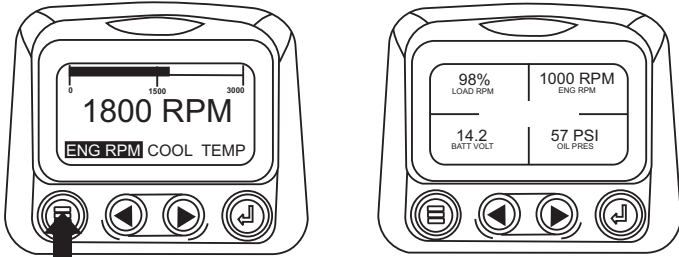

- The main menu will pop up on the display. Use the “Arrow Buttons” to scroll through the menu until the Stored Fault Codes is highlighted.

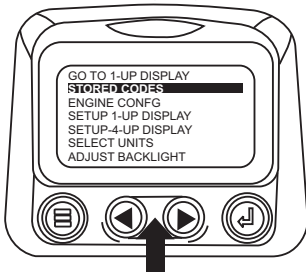

- Once the “Stored Fault Codes” menu item has been highlighted touch the “Enter Button” to view the “Stored Fault Codes” (when applicable, consult engine or transmission manufacturer for SAE J1939 supported parameters).

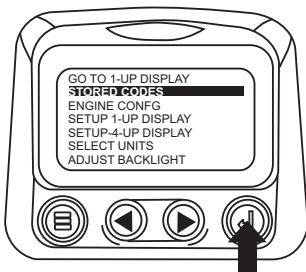

- If the word “MORE” appears above the “Arrow Buttons” there are more stored fault codes that may be viewed. Use the “Arrow Buttons” to scroll to the next Stored Diagnostic Code.



- Touch the “Menu Button” to return to the main menu.



- Touch the “Menu Button” to exit the Main menu and return to the engine parameter display.

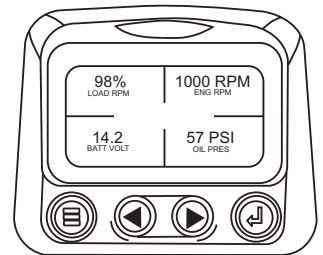
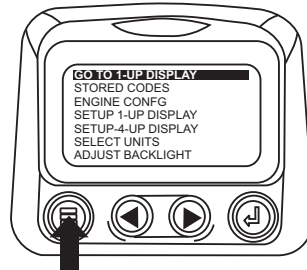

## Engine Configuration Data

- Starting at the single or four engine parameter display touch the “Menu Button”.

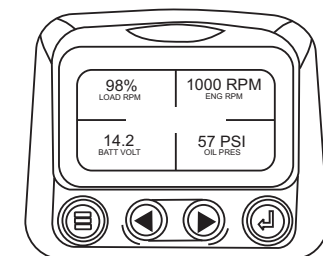
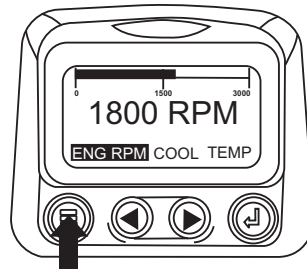

# DIAGNOSTIC DISPLAY

## First Time Start Up

1. When power is first applied to the diagnostic display, the “Logo” is displayed.



2. The “Wait to Start” message will be displayed for engines with a pre-startup sequence. Once the “Wait to Start” message is no longer displayed the operator may start the engine. Note: Displays only when SAE J1939 message is supported by engine manufacturer.



3. Once the engine has started the single engine parameter is displayed.



## Main Menu Navigation

1. Starting at the single or four engine parameter display, touch “Menu”.

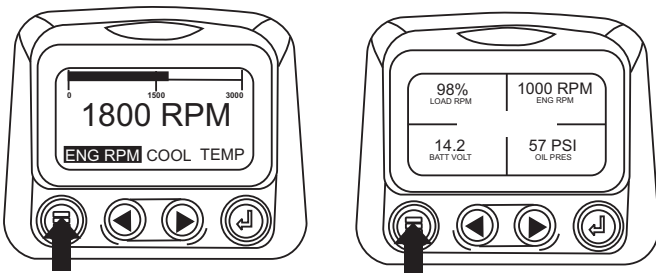

2. The first seven items of the “Main Menu” will be displayed. Touching the “Arrow Buttons” will scroll through the menu selection.

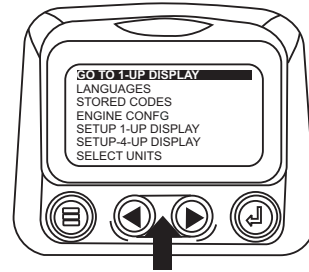

3. Touching the right arrow button will scroll down to reveal the last items of “Main Menu” screen highlighting the next item down.



4. Touch the “Arrows” to scroll to the desired menu item or touch “Menu” to exit the Main menu and return to the engine parameter display.

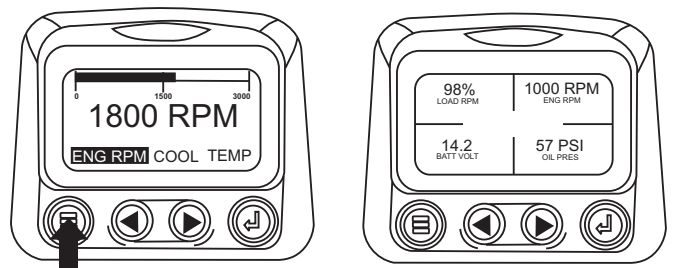

## Selecting a Language

1. Starting at the main menu display use the “Arrows” to scroll to the “Language” menu and once highlighted touch the “Enter” button.

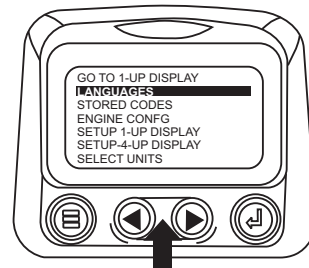

# DIAGNOSTIC DISPLAY

- The language choices will be displayed. Use the “Arrow” buttons to scroll through the selections and touch “Enter” to make a selection.



- Now that you have selected the language, touch the “Menu” button to return to the main menu display.

## Stored Fault Codes

- Starting at the single or the four engine parameter display touch the “Menu button”.

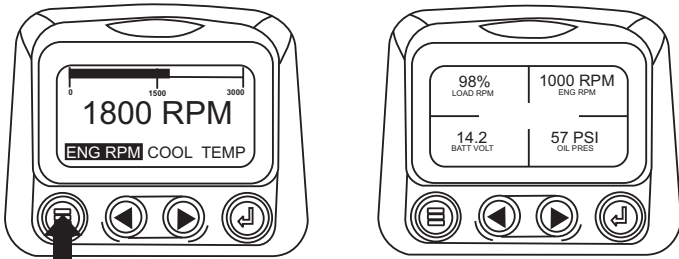

- The main menu will pop up on the display. Use the “Arrow Buttons” to scroll through the menu until the Stored Fault Codes is highlighted.

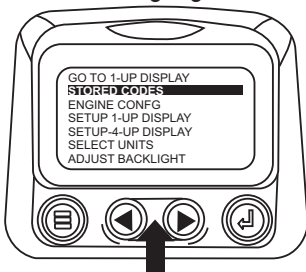

- Once the “Stored Fault Codes” menu item has been highlighted touch the “Enter Button” to view the “Stored Fault Codes” (when applicable, consult engine or transmission manufacturer for SAE J1939 supported parameters).

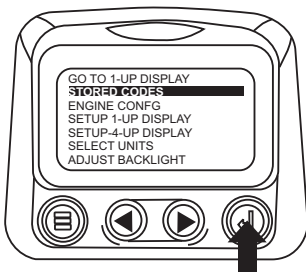

- If the word “MORE” appears above the “Arrow Buttons” there are more stored fault codes that may be viewed. Use the “Arrow Buttons” to scroll to the next Stored Diagnostic Code.

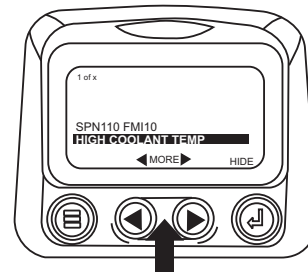

- Touch the “Menu Button” to return to the main menu.



- Touch the “Menu Button” to exit the Main menu and return to the engine parameter display.

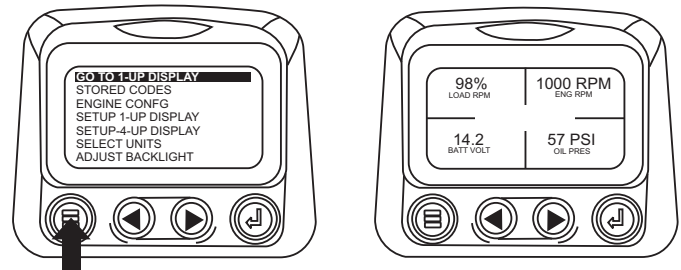

## Engine Configuration Data

- Starting at the single or four engine parameter display touch the “Menu Button”.

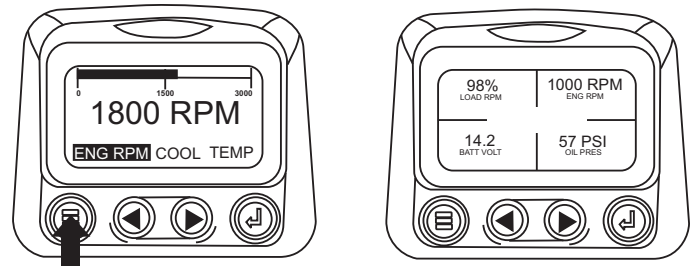



# DIAGNOSTIC DISPLAY

- The main menu will pop up on the display. Use the “Arrow Buttons” to scroll through the menu until the “Engine Configuration” menu item has been highlighted.

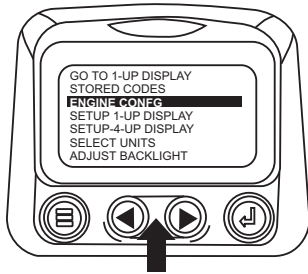

- Once the “Engine Configuration” menu item has been highlighted touch the “Enter Button” to view the engine configuration data.

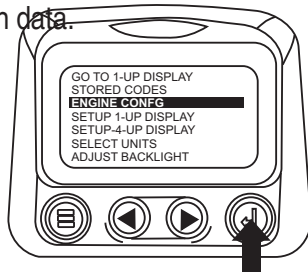

- Use the “Arrow Buttons” to scroll through the engine configuration data.

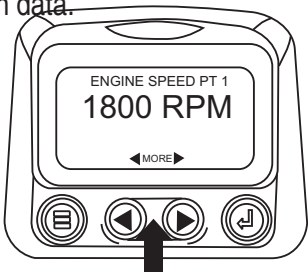

- Touch the “Menu Button” to return to the main menu.

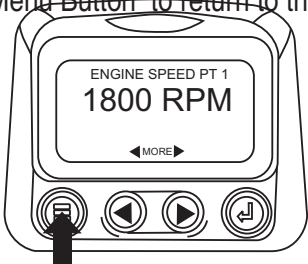

- Touch the “Menu Button” to exit the Main menu and return to the engine parameter display.

## FAULTS AND WARNINGS

### Auxiliary Gage Fault

- During normal operation the single or four parameter screen will be displayed.

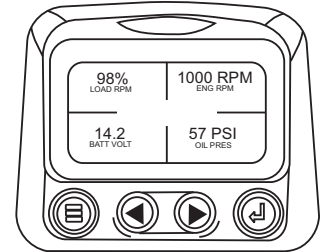
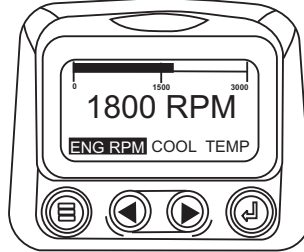

- The PVA Series of auxiliary gages can be attached to the PowerView. These auxiliary gages communicate with the Modbus master PowerView via a daisy-chained RS-485 port. If at any time during system initialization or normal operation an auxiliary gage should fail, the single or four parameter screen will be replaced with the “MLink Gage Fault” message.



- To acknowledge and “Hide” the fault and return to the single or four parameter display, touch the “Enter Button”.



- The display will return to the single or four parameter screen.

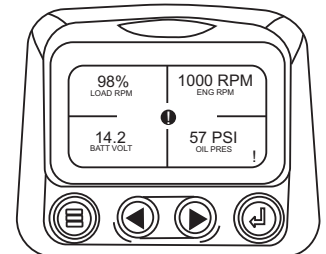
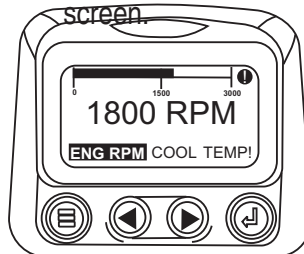

# DIAGNOSTIC DISPLAY

- ⓘ Indicates Auxiliary Gage Fault
- ▲ Indicates Fault Warning
- Ⓜ Indicates Derate or Shutdown Condition Fault

- Touching the “Enter Button” will redisplay the hidden fault. Touching the “Enter Button” once again will hide the fault and return the screen to the single or four parameter display. NOTE: The fault can only be cleared by correcting the cause of the fault condition.



## Active Fault Codes

- During normal operation the single or four parameter screen will be displayed.

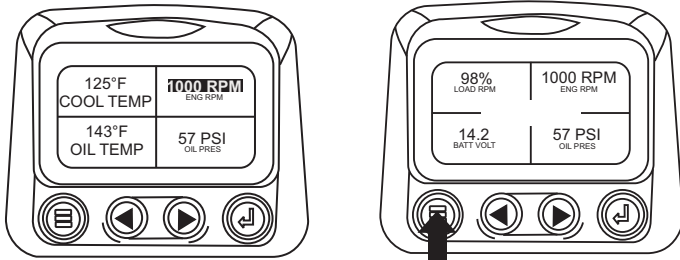

- When the PowerView receives a fault code from an engine control unit the single or four parameter screen will be replaced with the “Active Fault Codes” message.



- If the word “MORE” appears above the “Arrow Buttons”, there are more active fault codes that may be viewed. Use the “Arrow Buttons” to scroll to the next “Active Fault Code”.

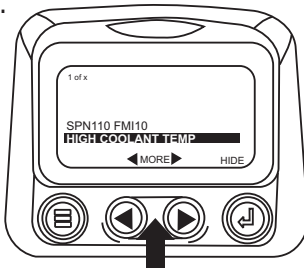

- To acknowledge and “Hide” the fault and return to the single or four parameter display touch the “Enter Button”.



- The display will return to the single or four parameter display but the display will contain the “Active Fault” warning icon. Touching the “Enter Button” will redisplay the hidden fault.

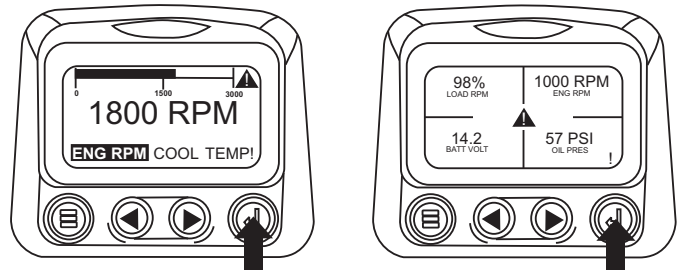

- Touching the “Enter Button” once again will hide the fault and return the screen to the single or four parameter display.



- The Single or Four parameter screen will display the fault icon until the fault condition is corrected. NOTE: Ignoring active fault codes could result in severe engine damage.

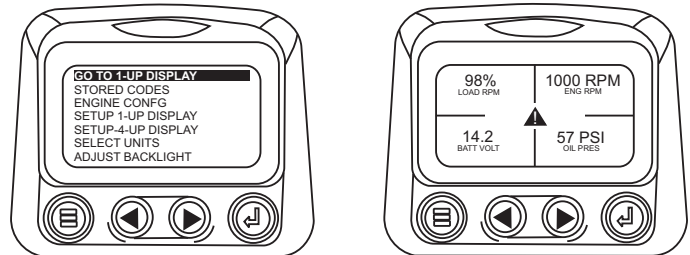

# DIAGNOSTIC DISPLAY

## Shut Down Codes

1. During normal operation the single or four parameter screen will be displayed.

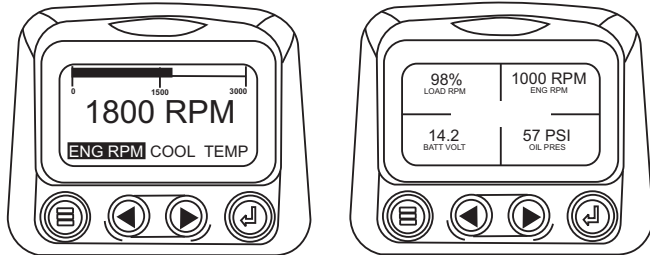

2. When the diagnostic display receives a severe fault code from an engine control unit the single or four parameter screen will be replaced with the "Shutdown" message.



3. To acknowledge and "Hide" the fault and return to the single or four parameter display touch the "Enter Button".

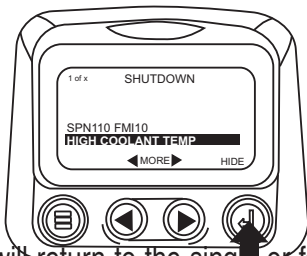

4. The display will return to the single or four parameter display, but the display will contain the "Shut Down" icon. Touching the "Enter Button" will redisplay the hidden fault.

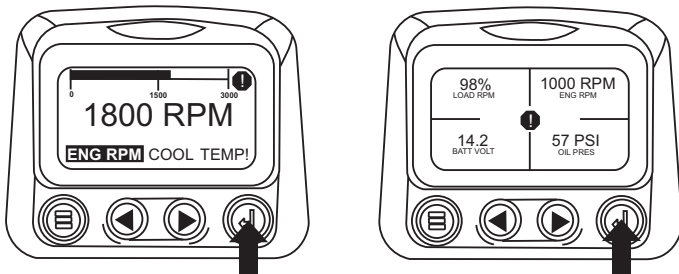

5. Touching the "Enter Button" once again will hide the fault and return the screen to the single or four parameter display.



6. The Single or Four parameter screen will display the fault icon until the fault condition is corrected. NOTE: Ignoring active fault codes could result in severe engine damage.

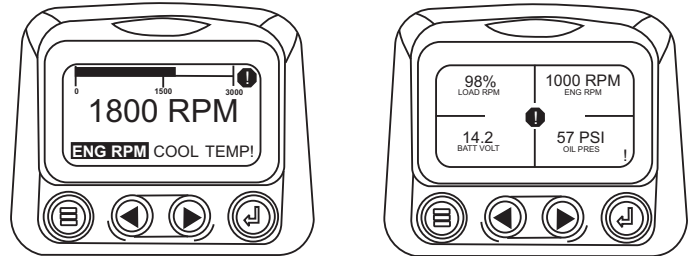

## Backlight Adjustment

1. Starting at the single or four engine parameter display touch the "Menu Button".

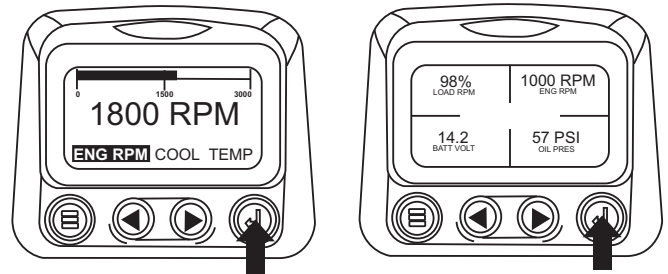

2. The main menu will pop up on the display. Use the "Arrow Buttons" to scroll through the menu until the "Adjust Backlight" is highlighted.

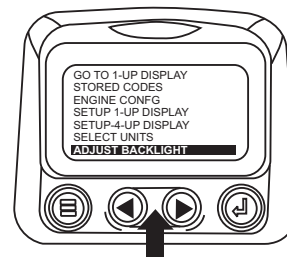

# DIAGNOSTIC DISPLAY

3. Once the "Adjust Backlight" menu item has been highlighted touch the "Enter Button" to activate the "Adjust Backlight" function.

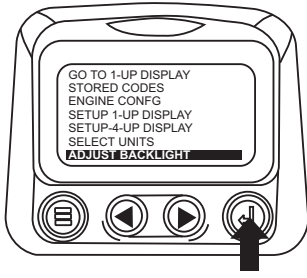

4. Use the "Arrow Buttons" to select the desired backlight intensity.

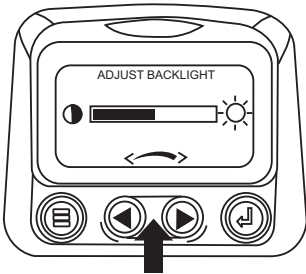

5. Touch the "Menu Button" to return to the main menu.

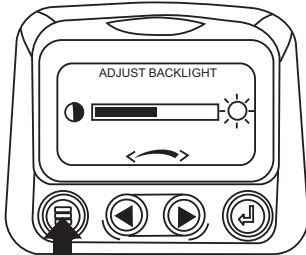

6. Touch the "Menu Button" to exit the Main menu and return to the engine parameter display.

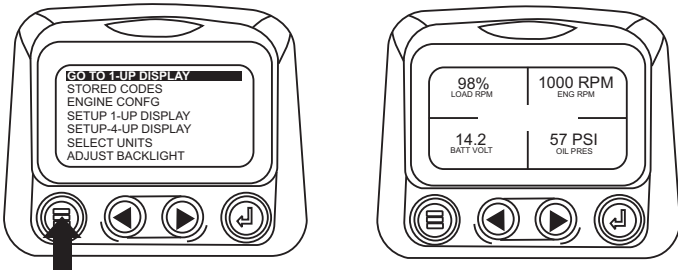

## Contrast Adjustment

1. Starting at the single or four engine parameter display, touch the "Menu Button".

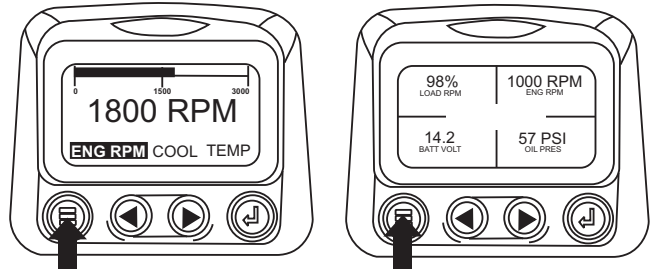

2. The main menu will pop up on the display. Use the "Arrow Buttons" to scroll through the menu until "Adjust Contrast" is highlighted.

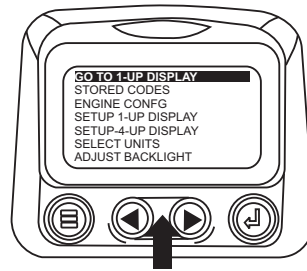

3. Once the "Adjust Contrast" menu item has been highlighted touch the "Enter Button" to activate the "Adjust Contrast" function.

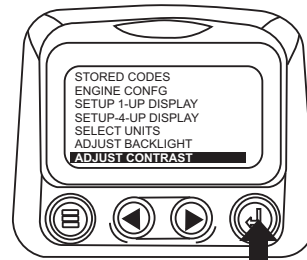

4. Use the "Arrow Buttons" to select the desired contrast intensity.

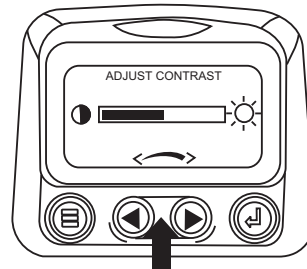

5. Touching the "Menu Button" will take you back through the menus.

# DIAGNOSTIC DISPLAY

## Select Units

1. Starting at the single or four engine parameter display touch the “Menu Button”.

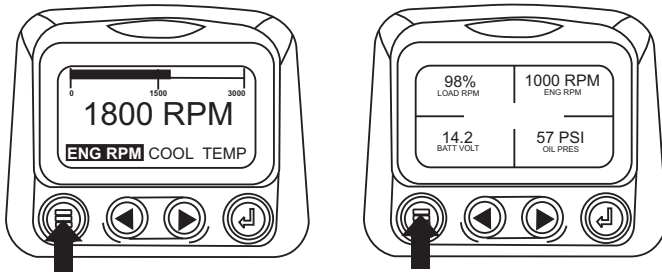

2. The main menu will pop up on the display. Use the arrow buttons to scroll through the menu until the “Select Units” is highlighted.

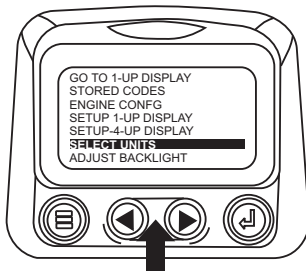

3. Once the “Select Units” menu item has been highlighted touch the “Enter Button” to access the “Select Units” function.

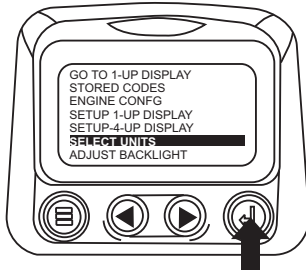

4. Use the arrows to highlight the desired units. “English” for imperial units i.e. PSI, °F or Metric kPa, Metric Bar for IS units i.e. kPa, Bar, °C.



5. Touch the “Enter Button” to select the highlighted units.

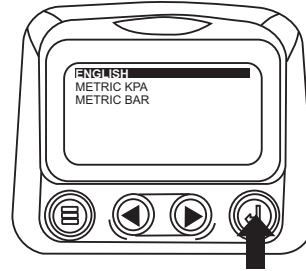

6. Touch the “Menu Button” to return to the “Main Menu”.

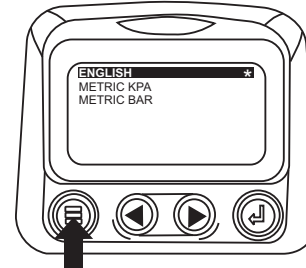

7. Touch the “Menu Button” to exit the Main menu and return to the engine parameter display.

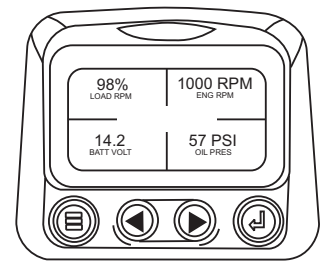
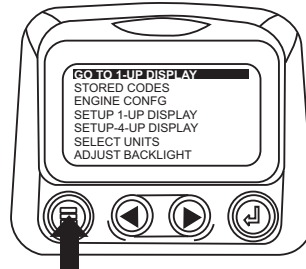

## Setup 1- Up Display

1. Starting at the single engine parameter display, touch the “Menu Button”.

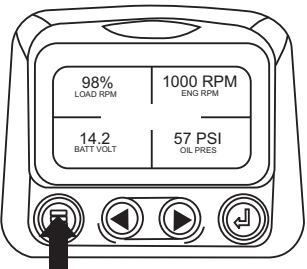
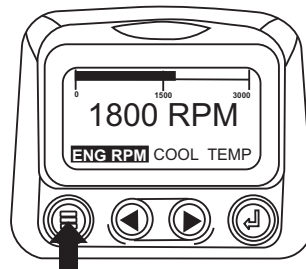

2. The main menu will pop up on the display. Use the “Arrow Buttons” to scroll through the menu until the “Setup 1-up Display” is highlighted.

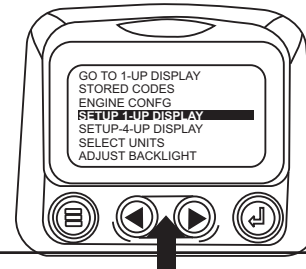



## DIAGNOSTIC DISPLAY

3. Once the “Setup 1-up Display” menu icon has been highlighted touch the “Enter Button” to access the “Setup 1-up display” function.

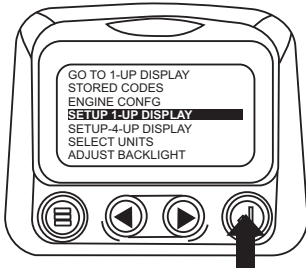

4. Three options are available for modification of the 1-Up display.

- Use defaults**- This option contains a set of engine parameters: Engine Hours, Engine RPM, System Voltage, Battery Voltage, % Engine Load at Current RPM, Coolant Temperature, Oil Pressure.
- Custom Setup**- This option allows for the modification of what parameter, the number of parameters, and the order in which the parameters are being displayed.
- Automatic scan** - Selecting the scan function will cause the 1-Up Display to scroll through the selected set of parameters one at a time, momentarily pausing at each.

5. Use Defaults- To select “Use Defaults” use the arrow buttons to scroll to and highlight “Use Defaults” in the menu display.



6. Touch the “Enter Button” to activate the “Use Defaults” function.



7. A message indicating the “Single Engine” parameter display parameters are reset to the factory defaults will be displayed, then the display will return to the “Custom Setup” menu.

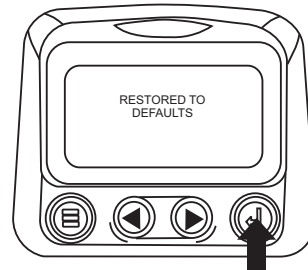

8. Custom Setup- To perform a custom setup of the 1-Up Display, use the arrow buttons to scroll to and highlight “Custom Setup” on the display.

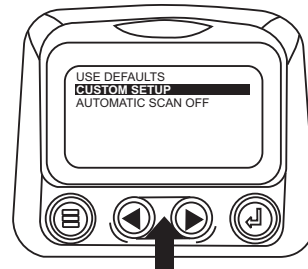

9. Touching the “Enter Button” will display a list of engine parameters.



10. Use the “Arrow Buttons” to scroll to and highlight a selected parameter (parameter with a # symbol to right of it).

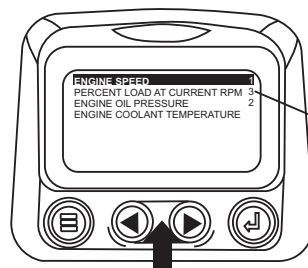

# DIAGNOSTIC DISPLAY

11. Touch the “Enter Button” to deselect the selected parameter removing it from the list of parameters being displayed on the 1-up display.

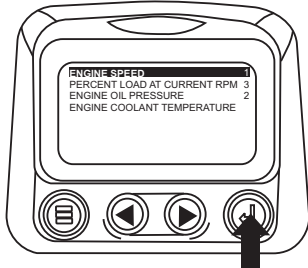

12. Use the “Arrow Button” to scroll and highlight the desired parameter that has not been selected for display.

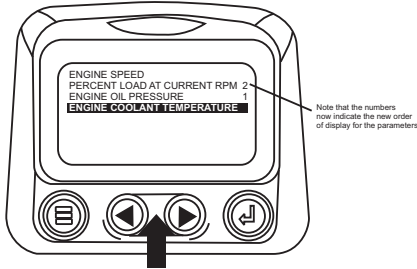

13. Touch the “Enter Button” to select the highlighted parameter for inclusion in the Single Engine Parameter Display.

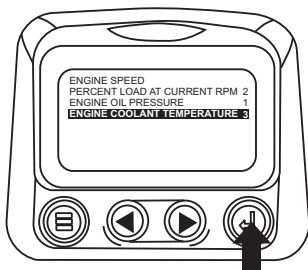

14. Continue to scroll and select additional parameters for the custom 1-up Display. Touch the “Menu Button” at any time to return to the “Custom Setup” menu.

15. Automatic Scan- Selecting the scan function will cause the 1-Up Display to scroll through the selected set of parameters one at a time. Use the “Arrow Buttons” to scroll to the “Automatic Scan” function.

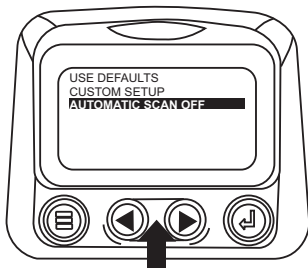

16. Touching the “Enter Button” toggles the “Automatic Scan” function on.



17. Touching the “Enter Button” again toggles the “Automatic Scan” function off.

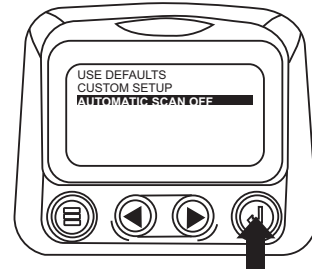

18. Once the “Use Defaults”, “Custom Setup” and “Automatic Scan” functions have been set touch the “Menu Button” to return to the main menu.

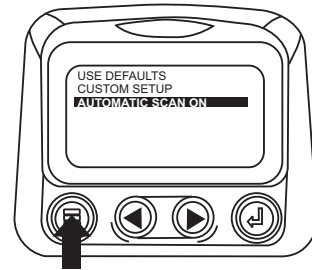

19. Touch the “Menu Button” to exit the Main menu and return to the engine parameter display.

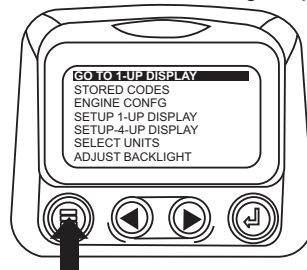

# DIAGNOSTIC DISPLAY

## Setup 4-Up Display

1. From the single or four engine parameter display touch the “Menu Button”.

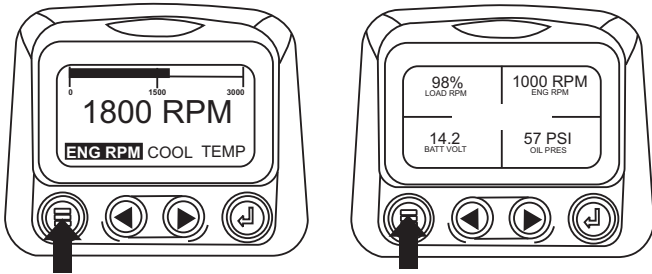

2. The main menu will pop up on the display. Use the “Arrow Buttons” to scroll through the menu until the “Setup 4-Up Display” is highlighted.



3. Once the “Setup 4-Up Display” menu item has been highlighted touch the “Enter Button” to activate the “Setup 4- Up Display” menu.

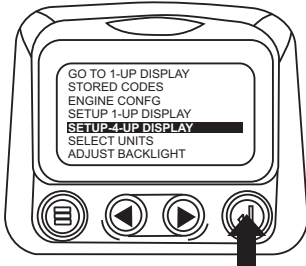

4. Touch the “Enter Button” to activate the “Use Defaults” function. This action will reset the unit to the factory default.



5. The “Use Defaults” screen will be displayed during the resetting period then will automatically return to the “Setup 4- Up Display” menu.

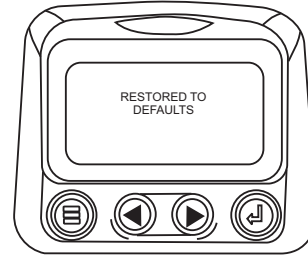

6. Select the “4-Up Custom Setup” from the “4-Up Setup” menu.

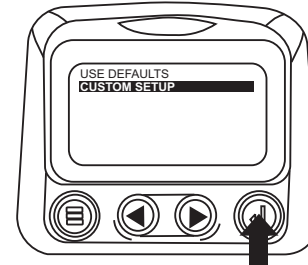

7. The quadrant with the backlit parameter value is the current selected parameter. Use the “Arrow Buttons” to highlight the parameter value in the quadrant you wish to place a new parameter.

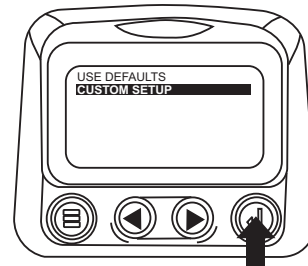

8. Touch the “Enter Button” and a list of parameters will appear.

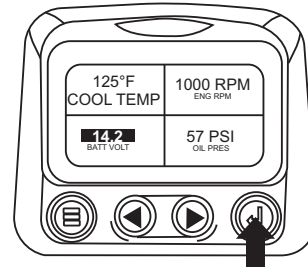



# DIAGNOSTIC DISPLAY

9. The parameter that is highlighted is the selected parameter for the screen. Use the “Arrow Buttons” to highlight the new parameter to be placed in the quadrant selected in the previous screen.

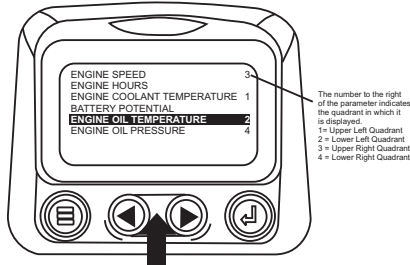

10. Touch the “Enter Button” to change the selected parameter in the quadrant to the new parameter.

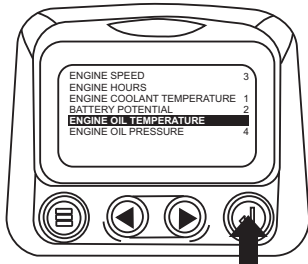

11. Use the “Menu Button” to return to the “4-Up Custom Setup” screen.

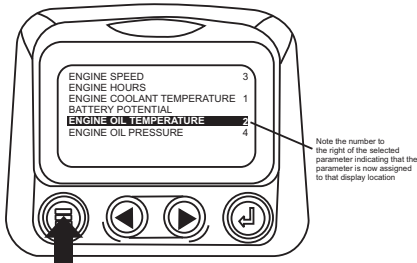

12. The parameter in the selected quadrant has changed to the parameter selected in the previous screen.

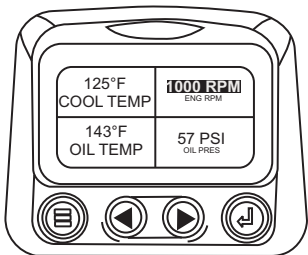

13. Repeat the parameter selection process until all spaces are filled.

14. Touch the “Menu Button” to return to the main menu.

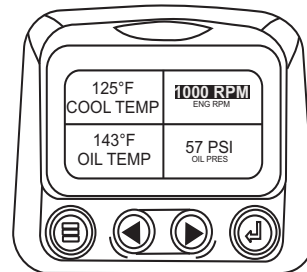

15. Touch the “Menu Button” to exit the Main menu and return to the engine parameter display.

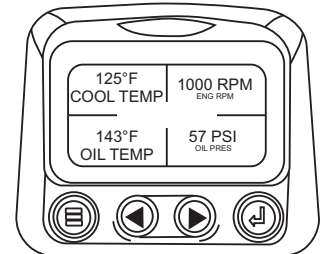

## Utilities

1. Starting at the single or four engine parameter display, touch the “Menu Button”.

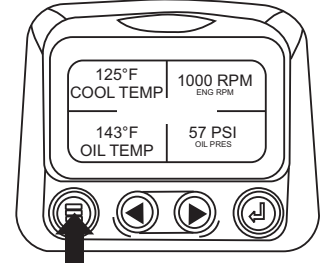
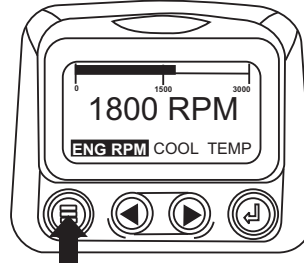

2. The main menu will be displayed. Use the “Arrow Buttons” to scroll through the menu until the “Utilities” is highlighted.

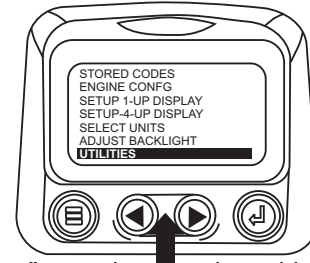

3. Once the “Utilities” menu item has been highlighted, touch the “Enter Button” to activate the “Utilities” functions.

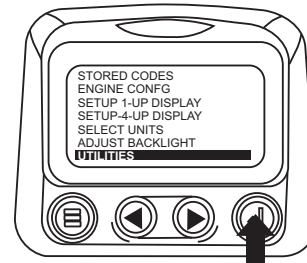

## DIAGNOSTIC DISPLAY

4. Touch "Select" to enter the "Gage Data" display. When "Gage Data" is selected the PowerView will communicate with the analog gages at a fixed rate of 38.4k Band, 8 data bits, no parity check, 1 stop bits, half duplex.

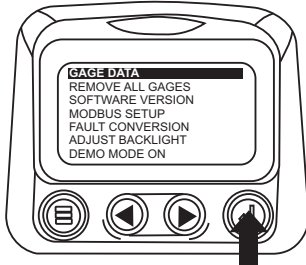

5. Use the "Arrow Buttons" to scroll through the items or touch "Menu" to return to the "Utilities" menu.



6. Touch "Menu Button" to return to the "Utilities" menu.



7. Use the "Arrows" to highlight "Remove All Gages". Touch "Select" to clear gage data from memory. It takes a moment to clear all gages.



8. When the gage data has cleared, the display automatically returns to the "Utilities" menu. Scroll to "Software Version". Touch "Select" to view the software version currently in the diagnostic display.



9. Touch "Menu" to return to "Utilities". Highlight "Fault Conversion" using the "Arrows". Touch "Select" to enter the Fault conversion menu.

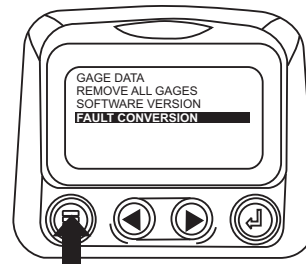

10. Use the "Arrows" to scroll to and highlight the desired version then touch "Select". An asterisk denotes which version is currently selected.

**NOTE:** There are four (4) different methods for converting fault codes. The diagnostic display always looks for J1939 Version 4 and can be set to read the code as one of three (3) other J1939 versions if Version 4 is not being used. Most engine ECU's use Version 4, therefore in most cases adjustment of this menu option will not be required.

Upon receiving an unrecognizable fault, change to a different J1939 Version. If the fault SPN does not change when the version is changed, the ECU generating the fault is using Fault Conversion method 4. If the SPN number does not change but is still unrecognizable, try changing to another J1939 Version not yet used and continue to check the SPN number.



# DIAGNOSTIC DISPLAY

11. Touch the “Menu” button to return to “Utilities” menu. Touch the “Menu button again to return to the “Main” menu.

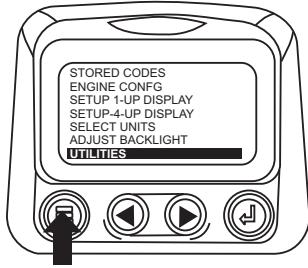

## MODBUS SETUP

1. Starting at the single or four engine parameter display, touch the “Menu Button”.

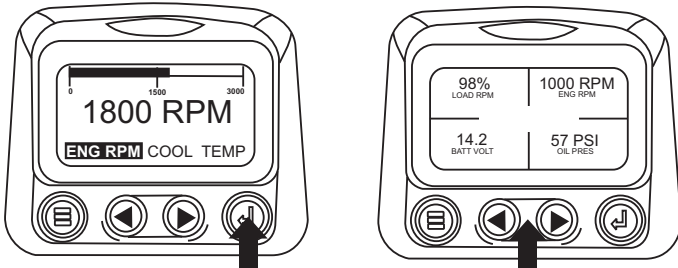

2. The main menu will be displayed. Use the “Arrow Buttons” to scroll through the menu until the “Utilities” menu is highlighted, then touch “Enter”.

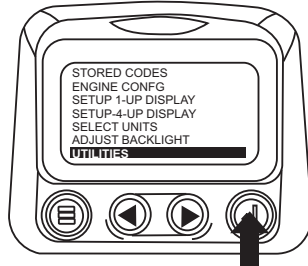

3. Once in the “Utilities” menu use the “Arrows” to scroll through the menu until the “Modbus Setup” menu is highlighted, then touch “Enter”.

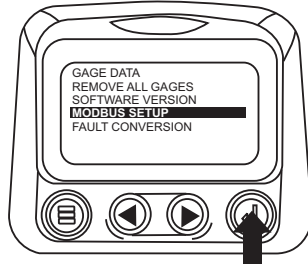

4. Use the “Arrows” to scroll down to and highlight either the “Slave Active or Master Active” modes. Touch the “Enter” button to toggle between master and slave.

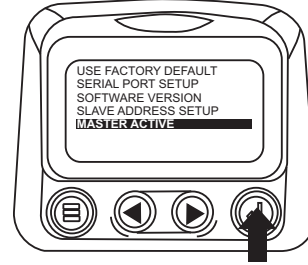

5. Use the “Arrows” to scroll to the “Serial Port” menu to highlight it, then touch “Enter”.

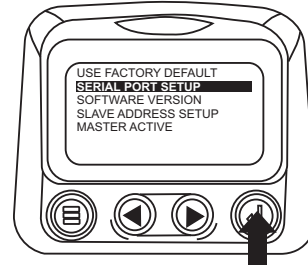

6. Use the “Arrow” button to scroll to each selection to configure the MODBUS values for your application.



7. When finished, touch “Menu” to return to the previous screen.

## GLOSSARY (Troubleshooting information)

### **CANBUS FAILURE**

Diagnostic Display has not received any CAN messages for at least 30 seconds.

### **NO DATA**

Diagnostic Display has not received the particular message being displayed for at least 5 seconds.

### **NOT SUPPORTED**

Diagnostic Display has received a message from the ECU stating the displayed message is not supported

### **DATA ERROR**

Diagnostic Display has received an error message from the ECU for the displayed message.

### **EMPTY**

No parameter selected for this 4- UP quadrant.

### **WAIT TO START PREHEATING**

This is a message from the engine indicating it is in a preheating cycle.

Wait until this message clears before starting the engine.

### **TIMEOUT ECU NOT RESPONDING**

The ECU did not respond to the PowerView request.

### **NO GAGE DATA**

The Diagnostic Display has no record of connected gages to the RS485 bus.

### **DISPLAY NOT VISIBLE**

Press and hold the "Menu" button for approximately 3 seconds.

# GENERATOR CONTROL PANEL

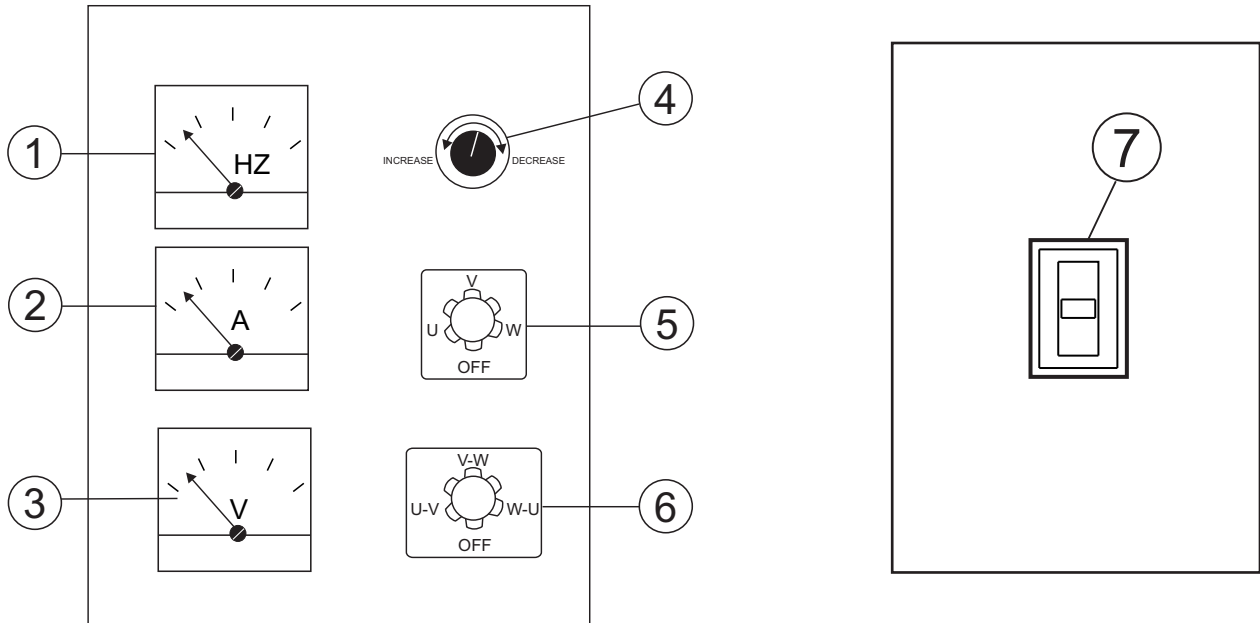

**Figure 7. Generator Control Panel**

The definitions below describe the controls and functions of the DCA-180SSJU (Figure 7).

1. **Frequency Meter** – Indicates the output frequency in hertz (Hz). Normally 60 Hz.
2. **AC Ammeter** – Indicates the amount of current the load is drawing from the generator per leg selected by the ammeter phase-selector switch.
3. **Ammeter Change-Over Switch** – This switch allows the AC ammeter to indicate the current flowing to the load connected to any phase of the output terminals, or to be switched off. This switch does not effect the generator output in any fashion, it is for current reading only.
4. **Voltage Regulator Control** – Allows  $\pm 15\%$  manual adjustment of the generator's output voltage.
5. **AC Voltmeter** – Indicates the output voltage present at the
6. **Voltmeter Change-Over Switch** – This switch allows the AC voltmeter to indicate phase to phase voltage between any two phases of the output terminals or to be switched off.
7. **Main Circuit Breaker** – This three-pole, 500A main breaker is provided to protect the the from overload.

Located behind the generator control panel is the . This box contains some of the necessary electronic components required to make the generator function.

The **Control Box** is equipped with the following major components:

- Over-Current Relay
- Voltage Rectifier (AVR)
- Starter Relay
- Current Transformer
- Voltage Selector Switch
- Three Phase Circuit Breaker

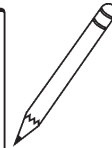
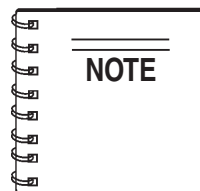

Remember the monitors the current flowing from the to the load.

In the event of a short circuit or over current condition, it will automatically trip the 500 amp main breaker.

To restore power to the , press the button on the overcurrent relay and place the circuit breaker in the position (**ON**).

# ENGINE OPERATING PANEL

The definitions below describe the controls and functions of the DCA-180SSJU (Figure 8).

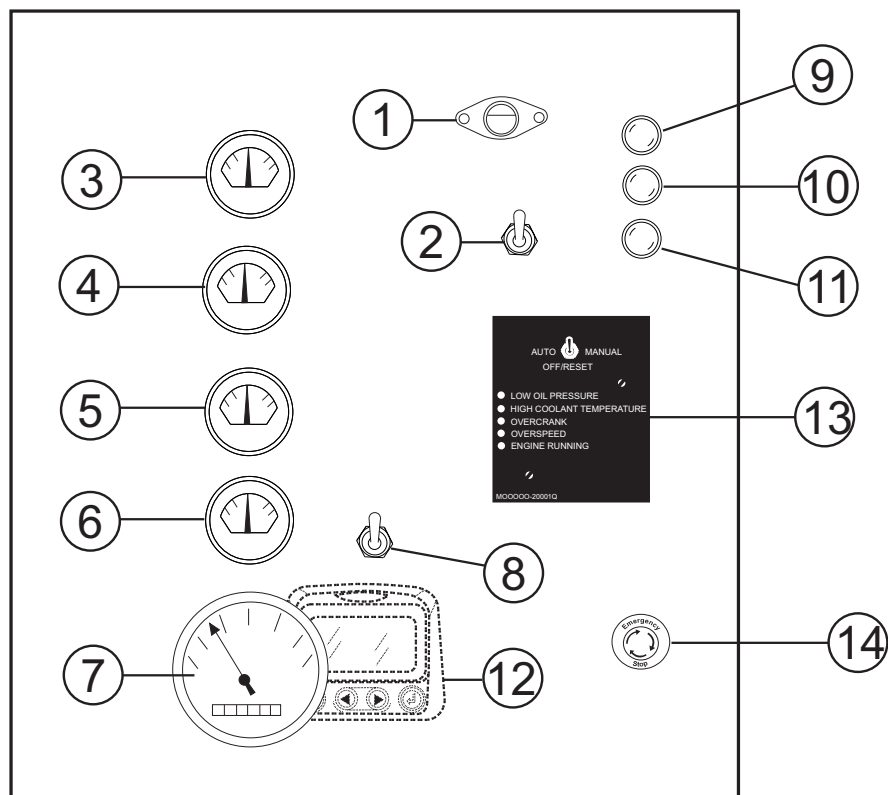

Figure 8. Engine Operating Panel

- 1. Panel Light** – Normally used in dark areas or at night time. When activated, panel lights will illuminate. When the generator is not in use be sure to turn the panel light switch to the **OFF** position.
- 2. Panel Light Switch** – When activated will turn on control panel light.
- 3. Oil Pressure Gauge** – During normal operation this gauge be should read between 35 to 65 psi. (241~448 kPa). When starting the generator the oil pressure may read a little higher, but after the engine warms up the oil pressure should return to the correct pressure range.
- 4. Water Temperature Gauge** – During normal operation this gauge be should read between 180° and 230°F. (82° C and 110° C
- 5. Charging Ammeter Gauge** – Indicates the current being supplied by the engine's alternator which provides current for generator's control circuits and battery charging system.
- 6. Fuel Gauge** - Indicates amount of diesel fuel available.
- 7. Tachometer** – Indicates engine speed in RPM's for 60 Hz operation. This meter should indicate 1800 RPM's when the rated load is applied. In addition a built in hour meter will record the number of operational hours that the generator has been in use.
- 8. Engine Speed Switch** – This switch controls the speed of the engine (low/high).

## ENGINE OPERATING PANEL

9. **Pre-Heat Lamp** – When lit, indicates engine is in the pre-heating mode (for starting during cold weather operating conditions). When lamp goes off engine is ready for starting.
10. **Warning Lamp** – This lamp will illuminate when a critical engine fault has occurred.
11. **Emergency Stop Lamp** – This lamp will illuminate when the emergency stop button has been pressed or a critical engine fault has occurred.
12. **Diagnostic Display** – This display monitors critical engine functions. If any abnormal conditions occur, an Active Fault Code will be displayed. This diagnostic display can be located inside the control box.

13. **Auto On/Off Engine Controller (MPEC)** – This controller has a vertical row of status LED's (inset), that when lit, indicate that an engine malfunction (fault) has been detected. When a fault has been detected the engine controller will evaluate the fault and all major faults will shutdown the generator. During , The MPEC will attempt to crank the engine for 10 seconds before disengaging.

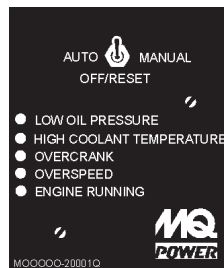

14. **Emergency Stop Button** – In the event of an emergency, press this button to shutdown the generator.

If the engine does not engage (start) by the third attempt, the engine will be shutdown by the engine controller's mode. If the engine engages at a speed (RPM's) that is not safe, the controller will shutdown the engine by initializing the mode.

Also the engine controller will shut down the engine in the event of low oil pressure, high coolant temperature, low coolant level, and loss of magnetic pickup. These conditions can be observed by monitoring the **LED** status indicators on the front of the controller module.

- A. **MPEC Control Switch** – This switch controls the running of the unit. If this switch is set to the **OFF/RESET** position, the unit will not run. When this switch is set to the **MANUAL** position, the generator will start immediately.

If the generator is to be connected to a building's AC power source via an automatic transfer switch (isolation), place the switch in the **AUTO** position. In this position, should an outage occur, the automatic transfer switch (ATS) will start the generator automatically via the generator's auto-start contacts connected to the ATS's start contacts. Please refer to your ATS installation manual for further instructions for the correct installation of the auto-start contacts of the generator to the ATS.

- B. **Low Oil Pressure** – Indicates the engine pressure has fallen below 15 psi. The oil pressure is detected using variable resistive values from the oil pressure sending unit. This is considered a fault.
- C. **High Coolant Temperature** – Indicates the engine temperature has exceeded 239°F. The engine temperature is detected using variable resistive values from the temperature sending unit. This is considered a fault.
- D. **Overcrank Shutdown** – Indicates the unit has attempted to start a pre-programmed number of times, and has failed to start. The number of cycles and duration are programmable. It is pre-set at 3 cycles with a 10 second duration. This is considered a fault.
- E. **Overspeed Shutdown** – Indicates the engine is running at an unsafe speed. This is considered a fault.
- F. **Engine Running** – Indicates that engine is running at a safe operating speed.



# OUTPUT TERMINAL PANEL FAMILIARIZATION

## Output Terminal Panel

The (Figure 9) shown below is located on the right-hand side (left from control panel) of the generator. Lift up on the cover to gain access to receptacles and terminal lugs.

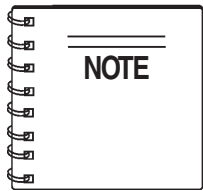

Terminal legs "O" and "Ground" are considered .

## Output Terminal Familiarization

The " " (Figure 9) is provided with the following:

- Three (3) 120/240V output receptacles @ 50 amp
- Three (3) Circuit Breakers @ 50 amps
- Two (2) 100V GFCI receptacles @ 20 amp
- Two (2) GFCI Circuit Breakers @ 20 amps
- Five (5) Output Terminal Lugs ( U, V, W, O, Ground)

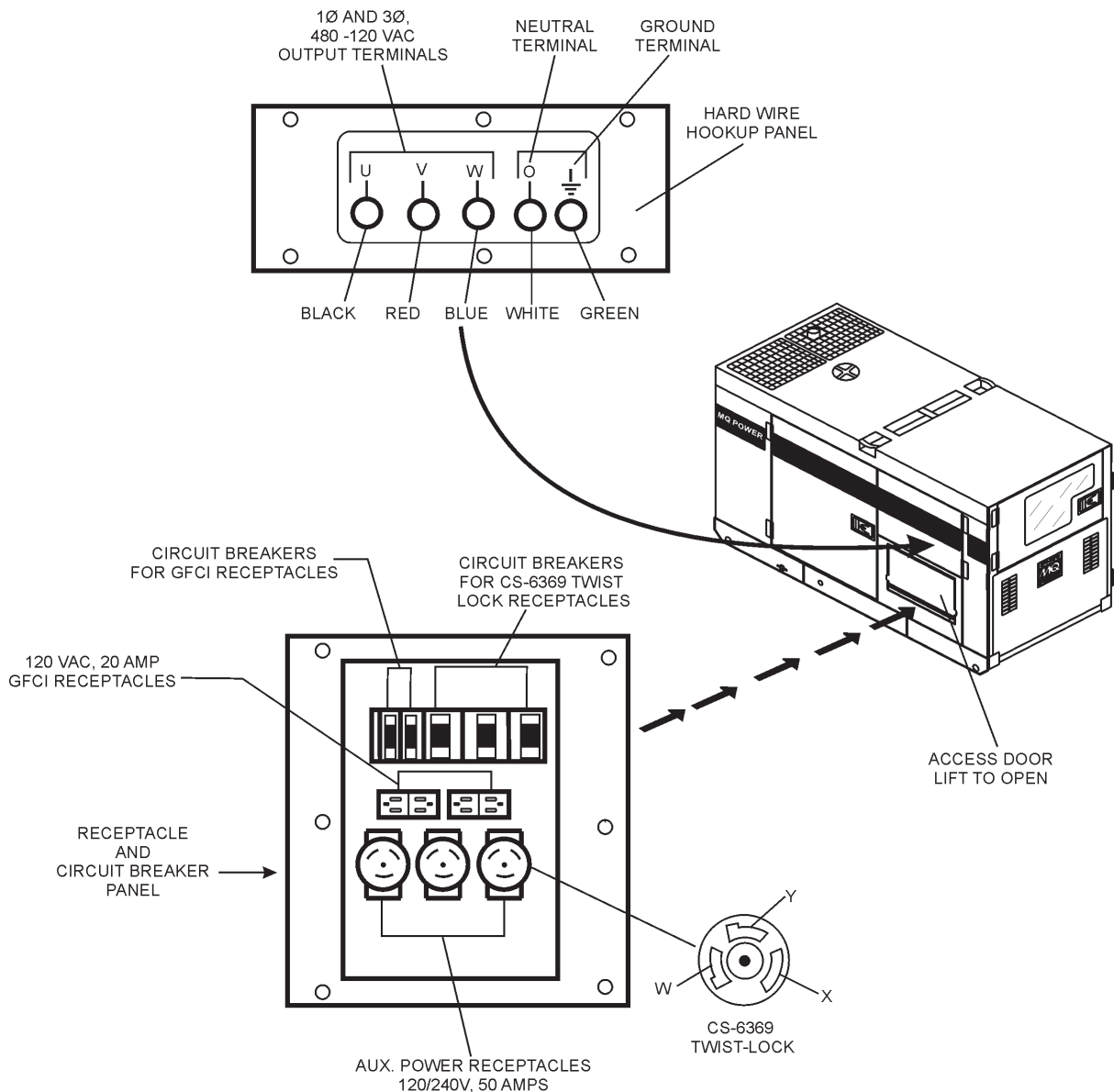

Figure 9. Output Terminal Panel



# OUTPUT TERMINAL PANEL FAMILIARIZATION

## 120 VAC GFCI Receptacles

There are two 120 VAC, 20 amp GFCI (Duplex Nema 5-20R) receptacles provided on the output terminal panel. These receptacles can be accessed in any

position. Each receptacle is protected by a 20 amp circuit breaker. These breakers are located directly above the GFCI receptacles. Remember the load output (current) of both GFCI receptacles is dependent on the load requirements of the U, V, and W output terminal lugs.

Pressing the                      button resets the GFCI receptacle after being tripped. Pressing the                      (See Figure 10) in the center of the receptacle will check the GFCI function. Both receptacles should be tested at least once a month.

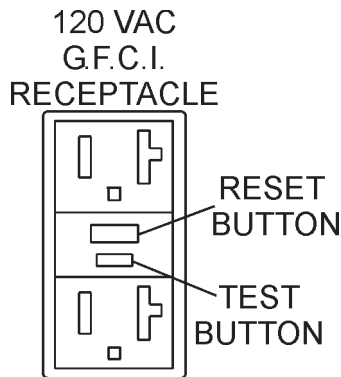

Figure 10. G.F.C.I. Receptacle

## Twist Lock Dual Voltage 120/240 VAC Receptacles

There are three 240/139V, 50 amp auxilliary twist-lock (CS-6369) receptacles (Figure 11) provided on the output terminal panel. These receptacles can be accessed when the voltage change-over board is configured for

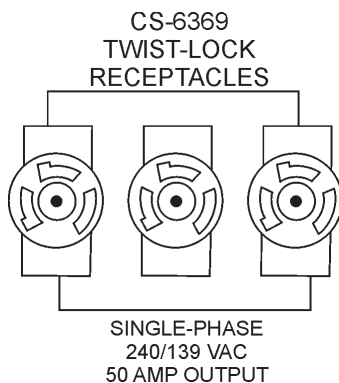

Figure 11. 240/139V Twist-Lock Auxiliary Receptacles

Each auxilliary receptacle is protected by a 50 amp circuit breaker. These breakers are located directly above the GFCI receptacles. Remember the load output (current) on all three receptacles is dependent on the load requirements of the

Turn the                      (Figure 12) on the control panel to obtain the desired voltage. Turning the knob clockwise will                      the voltage, turning the knob counter-clockwise will                      the voltage.



Figure 12. Voltage Regulator Control Knob

## Removing the Plastic Face Plate (Hard Wire Hookup Panel)

The                      are protected by a plastic face plate cover (Figure 13). Un-screw the securing bolts and lift the plastic terminal cover to gain access to the terminal enclosure.

After the load wires have been securely attached to the terminal lugs, reinstall the plastic face plate.

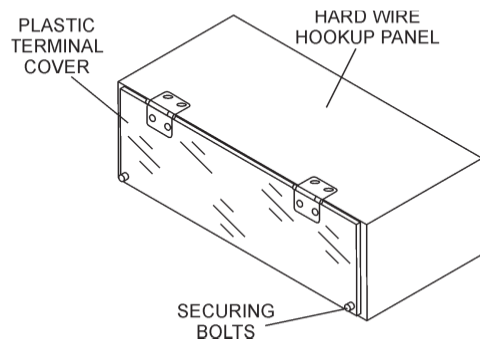

Figure 13. Plastic Face Plate (Output Terminal Lugs)

# OUTPUT TERMINAL PANEL FAMILIARIZATION

## Connecting Loads

Loads can be connected to the generator by the  or the convenience receptacles (Figure 14). Make sure to read the operation manual before attempting to connect a load to the generator.

To protect the output terminals from overload, a 3-pole, 500A  circuit breaker is provided. Make sure to switch **ALL** circuit breakers to the **OFF** position prior to starting the engine.

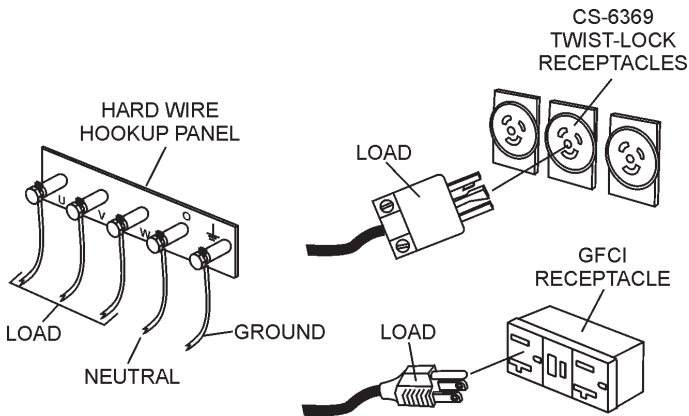

Figure 14. Connecting Loads

## Over Current Relay

An  (Figure 15) is connected to the main circuit breaker. In the event of an overload, both the circuit breaker and the over current relay may trip. If the circuit breaker can not be reset, the  on the over current relay must be pressed. The over current relay is located in the control box.

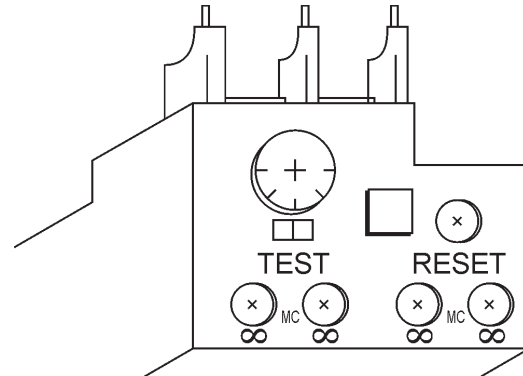

Figure 15. Over Current Relay

# LOAD APPLICATION

## Single Phase Load

Always be sure to check the nameplate on the generator and equipment to insure the wattage, amperage, frequency, and voltage requirements are satisfactorily supplied by the generator for operating the equipment.

Generally, the wattage listed on the nameplate of the equipment is its rated output. Equipment may require 130—150% more wattage than the rating on the nameplate, as the wattage is influenced by the efficiency, power factor and starting system of the equipment.

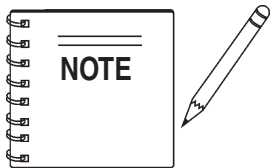

If wattage is not given on the equipment's name plate, approximate wattage may be determined by multiplying nameplate voltage by the nameplate amperage.

$$\text{WATTS} = \text{VOLTAGE} \times \text{AMPERAGE}$$

The power factor of this generator is 0.8. See Table 5 below when connecting loads.

**Table 5. Power Factor By Load**

Type Of Load	Power Factor
Single-phase induction motors	0.4 - 0.75
Three-phase induction motors	0.65 - 0.85
Electric heaters, incandescent lamps	1.0
Fluorescent lamps, mercury lamps	0.4 - 0.9
Electronic devices, communication equipment	1.0
Common power tools	0.8

**Table 6. Cable Selection (60 Hz, Single Phase Operation)**

Current in Amperes	Load In Watts		Maximum Allowable Cable Length			
	At 100 Volts	At 200 Volts	#10 Wire	#12 Wire	#14 Wire	#16 Wire
2.5	300	600	1000 ft.	600 ft.	375 ft.	250 ft.
5	600	1200	500 ft.	300 ft.	200 ft.	125 ft.
7.5	900	1800	350 ft.	200 ft.	125 ft.	100 ft.
10	1200	2400	250 ft.	150 ft.	100 ft.	
15	1800	3600	150 ft.	100 ft.	65 ft.	
20	2400	4800	125 ft.	75 ft.	50 ft.	

CAUTION: Equipment damage can result from low voltage.

## Three Phase Load

When calculating the power requirements for 3-phase power use the following equation:

$$\text{KVA} = \frac{\text{VOLTAGE} \times \text{AMPERAGE} \times 1.732}{1000}$$

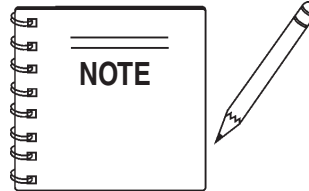

If 3Ø load (kVA) is not given on the equipment nameplate, approximate 3Ø load output maybe determined by multiplying voltage by amperage by 1.732.

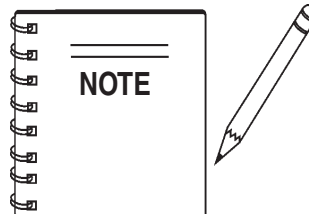

Motors and motor-driven equipment draw much greater current for starting than during operation.

An inadequate size connecting cable which cannot carry the required load can cause a voltage drop which can burn out the appliance or tool and overheat the cable. See Table 6.

- When connecting a resistance load such as an incandescent lamp or electric heater, a capacity of up to the generating set's rated output (kW) can be used.
- When connecting a fluorescent or mercury lamp, a capacity of up to the generating set's rated output (kW) multiplied by 0.6 can be used.
- When connecting an electric drill or other power tools, pay close attention to the required starting current capacity.

When connecting ordinary power tools, a capacity of up to the generating set's rated output (kW) multiplied by 0.8 can be used.

### **! DANGER - ELECTRICAL SYSTEM HAZARDS**

Before connecting this generator to any building's electrical system, a \_\_\_\_\_ must install an \_\_\_\_\_ . Serious damage to the building's electrical system may occur without this transfer switch.

# GENERATOR OUTPUTS

## Generator Output Voltages

A wide range of voltages are available to supply voltage for many different applications. Voltages are selected by applying jumpers (6) to the (Figure 16). To obtain some of the voltages as listed in Table 7 (see below) will require a fine adjustment using the (VR) located on the control panel.

## Voltage Change-Over Board

The (Figure 16) is located on the control box, behind the generator control panel. This board has been provided for ease of voltage selection.

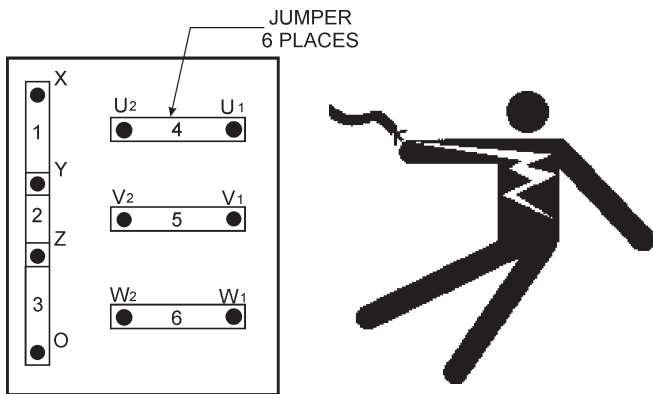

Figure 16. Voltage Change-Over Board

## Maximum Amps

Table 8 shows the amps the generator can provide. **DO NOT** exceed the maximum amps as listed.

Table 8. Generator Maximum Amps	
Rated Voltage	Maximum Amps
Single Phase 120 Volt	400 amps (4 wire)
Single Phase 240 Volt	200 amps (4 wire)
Three Phase 240 Volt	433 amps
Three Phase 480 Volt	216 amps

**CAUTION - CHANGING VOLTAGES**

**NEVER** attempt to place jumper plates on the while the generator is in operation. There exist the possibility of

!

Table 7. Voltages Available						
Three Phase (Selectable)	208V	220V	240V	416V	440V	480V
Single Phase (Selectable)	120V	127V	139V	240V	254V	277V

# GENERATOR OUTPUTS/ GAUGE READING

## How to Read the AC Ammeter and AC Voltage Gauges.

The AC ammeter and AC voltmeter gauges are controlled by the AC ammeter and AC voltmeter change-over switches.

Both of these switches are located on the control panel and **DO NOT** effect the generator output. They are provided to help observe the phase to phase voltage and the current flowing to the load at the UVWO output terminals lugs.

Observe that the voltage change-over board (Figure 17) has been configured for 3Ø, 240V operation.

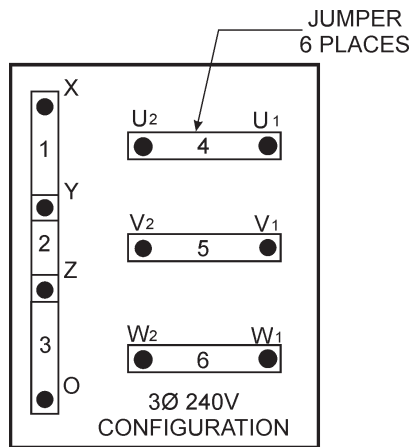

**Figure 17. Change-Over Board (3Ø 240V Configuration)**

## AC Voltmeter Gauge Reading

Place the (Figure 18) in the W-U position and observe the phase to phase voltage reading between the W and U terminals as indicated on the (Figure 19).

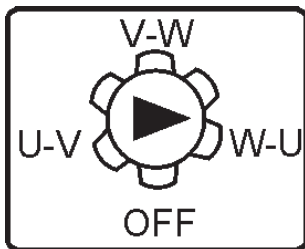

**Figure 18. AC Voltmeter Change-Over Switch**

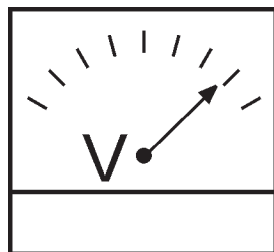

**Figure 19. AC Voltmeter Gauge (Volt reading on W-U Lug)**

## AC Ammeter Gauge Reading

Place the (Figure 20) to the U position and observe the current reading (load drain) on the U terminal as indicated on the (Figure 21). This process can be repeated for terminals V and W.

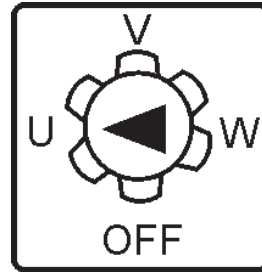

**Figure 20. AC Ammeter Change-Over Switch**

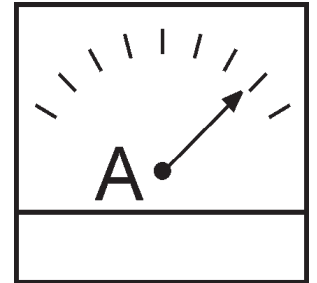

**Figure 21. AC Ammeter (Amp reading on U lug)**

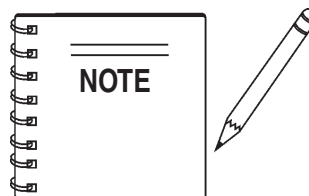

The gauge will only show a reading when the are connected to a load and in use.

# OUTPUT TERMINAL PANEL CONNECTIONS

## UVWO Terminal Output Voltages

Various output voltages can be obtained using the UVWO output terminal lugs. The voltages at the terminals are dependent on the placement of the jumpers plates (6) on the and the adjustment of the

Remember the voltage change-over board determines the of the output voltage and can be configured in two different positions that provide 6 different output voltages at the UVWO output terminals. The generator is shipped from the factory in the 240V configuration. The voltage regulator (VR) allows the user to increase or decrease the selected voltage.

## 3Ø-240V UVWO Terminal Output Voltages

1. Jumper the voltage change-over board for 240V operation as shown in Figure 22.

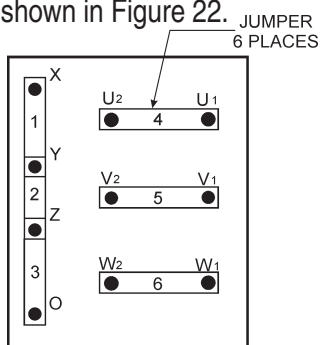

Figure 22. Voltage Change-Over Board 240V Configuration

2. Connect the load wires to the UVWO terminals as shown in Figure 23.

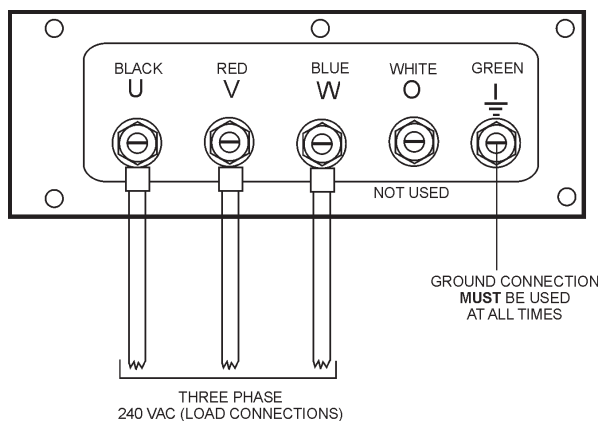

Figure 23. UVWO Terminal Lugs 3Ø-240V Connections

3. Turn the voltage regulator knob (Figure 24) clockwise to increase voltage output, turn counterclockwise to decrease voltage output. Use voltage regulator adjustment knob whenever fine tuning of the output voltage is required



Figure 24. Voltage Regulator Knob

## 1Ø-240V UVWO Terminal Output Voltages

1. Make sure the voltage change-over board is jumpered for 240V operation as shown in Figure 22.
2. Connect the load wires to the UVWO terminals as shown in Figure 25.

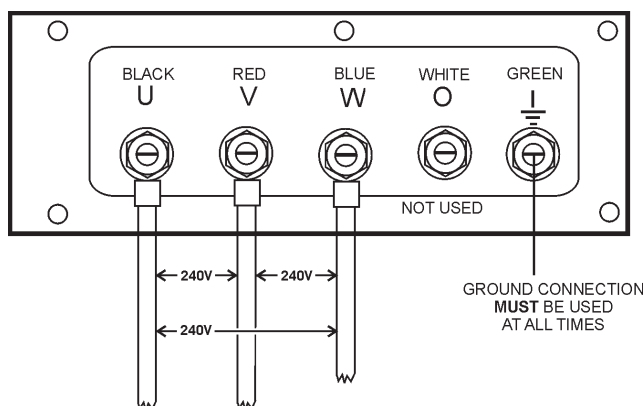

Figure 25. UVWO Terminal Lugs 1Ø-240V Connections

## 1Ø-120V UVWO Terminal Output Voltages

1. Make sure the voltage change-over board is jumpered for 240V operation as shown in Figure 22.
2. Connect the load wires to the UVWO terminals as shown in Figure 26.

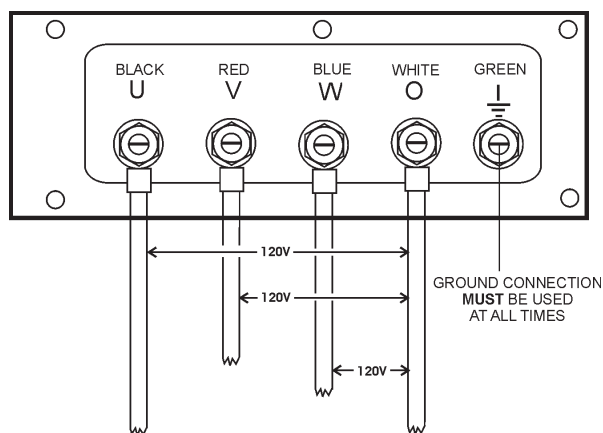

Figure 26. UVWO Terminal Lugs 1Ø-120V Connections



# OUTPUT TERMINAL PANEL CONNECTIONS

## 3Ø-480 UVWO Output Terminal Voltages

1. Jumper the voltage change-over board for 480V operation as shown in Figure 27. This configuration uses 6 jumper plates in 3 different positions. Remember there are 2 jumper plates at every position. Every jumper plate must be used.

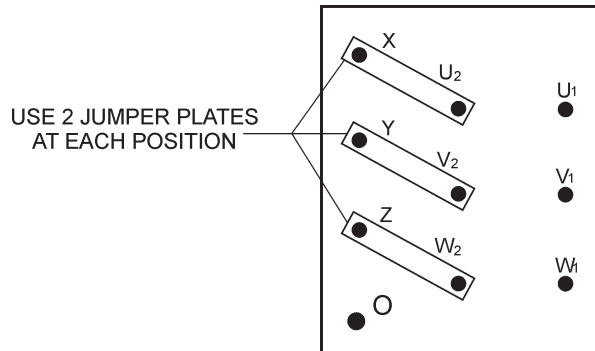

Figure 27. Voltage Change-Over Board  
480V Configuration

2. Connect the load wires to the as shown in Figure 28.

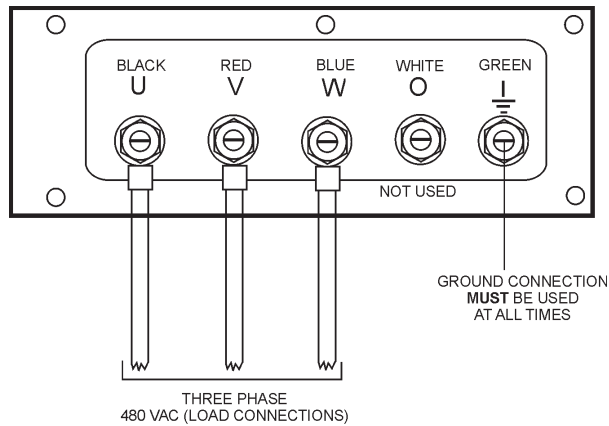
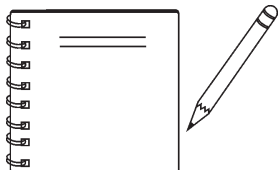

Figure 28. Output Terminal Lugs  
3Ø-480V Connections

3. Turn the voltage regulator knob (Figure 24) clockwise to increase voltage output, turn counterclockwise to decrease voltage output.



**ALWAYS** make sure that the connections to the UWVO terminals are secure and tight. The possibility of arcing exists, which could cause a fire

## 1Ø-480V UVWO Terminal Output Voltages

1. Make sure the voltage change-over board is jumpered for 480V operation as shown in Figure 27.
2. Connect the load wires to the as shown in Figure 29.

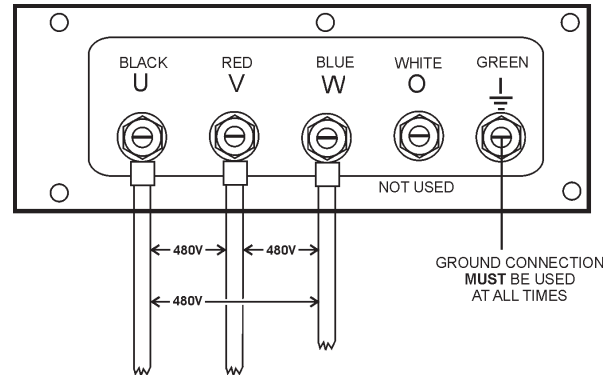

Figure 29. UWVO Output Terminal Lugs  
1Ø-480V Connections

## 1Ø-277V UVWO Terminal Output Voltages

1. Make sure the voltage change-over board is jumpered for 480V operation as shown in Figure 27.
2. Connect the load wires to the as shown in Figure 30.

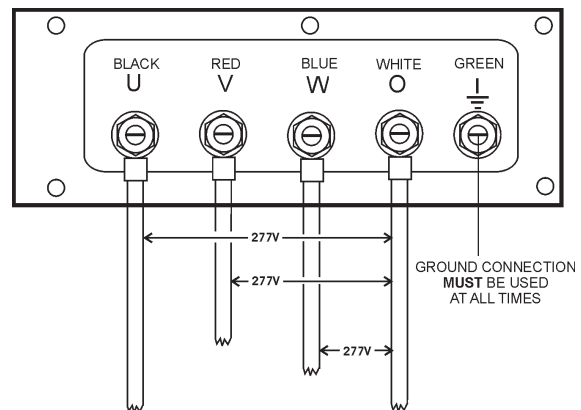

Figure 30. UWVO Output Terminal Lugs  
1Ø-277V Connections

3. Turn the voltage regulator knob (Figure 24) clockwise to increase voltage output, turn counterclockwise to decrease voltage output.

## Circuit Breakers

To protect the generator from an overload, a 3-pole, 500 amp, \_\_\_\_\_ circuit breaker is provided to protect the \_\_\_\_\_ from overload. In addition two single-pole, 20 amp \_\_\_\_\_ circuit breakers are provided to protect the GFCI receptacles from overload. Three 50 amp \_\_\_\_\_ circuit breakers have also been provided to protect the auxiliary receptacles from overload. Make sure to switch **ALL** circuit breakers to the **OFF** position prior to starting the engine.

## Lubrication Oil

Fill the engine crankcase with lubricating oil through the filler hole, but **DO NOT** overfill. Make sure the generator is level. \_\_\_\_\_ and verify that the oil level is maintained between the two notches (Figure 31) on the dipstick. See Table 9 for proper selection of engine oil.

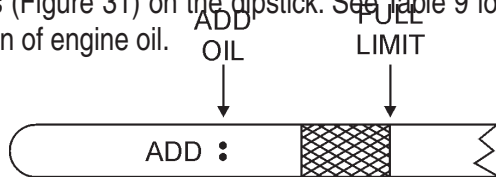

**Figure 31. Engine Oil Dipstick**

When checking the engine oil, be sure to check if the oil is clean. If the oil is not clean, drain the oil by removing the oil drain plug, and refill with the specified amount of oil as outlined in the **John Deere Engine Owner's Manual**. Oil should be warm before draining.

Other types of motor oils may be substituted if they meet the following requirements:

- API Service Classification CC/SC
- API Service Classification CC/SD
- API Service Classification CC/SE
- API Service Classification CC/SF

Table 9. Recommended Motor Oil		OIL: SAE	
°F	°C		
122	50		
104	40	10W/40	30
86	30		
68	20		
50	10		
32	0		
-14	-10	5W/30	10W/40
-4	-20	ARCTIC OIL	15W/30
-22	-30		10W/30
-40	-40		10W
			20W/40

## Fuel Check

**! DANGER - EXPLOSION/FIRE HAZARDS**

Fuel spillage on a \_\_\_\_\_ engine can cause a \_\_\_\_\_ or \_\_\_\_\_. If fuel spillage occurs, wipe up the spilled fuel completely to prevent fire hazards. **NEVER** smoke around or near the generator.

## Refilling the Fuel System

**! CAUTION - REFUELING THE GENERATOR**

**ONLY properly trained personel** who have read and understand this section should refill the fuel tank system.

This generator has an internal fuel tank located inside the trailer frame and may also be equipped with an environmental fuel tank (Figure 32). \_\_\_\_\_ fill the fuel tanks with clean fresh \_\_\_\_\_ **DO NOT** fill the fuel tanks beyond their capacities.

Pay attention to the fuel tank capacity when replenishing fuel. The fuel tank cap must be closed tightly after filling. Handle fuel in a safety container. If the container does not have a spout, use a funnel. Wipe up any spilled fuel immediately.

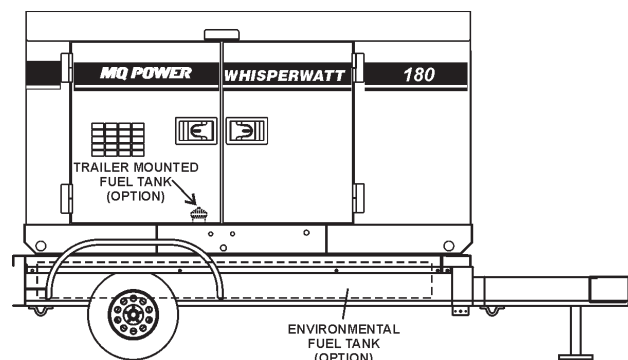

**Figure 32. Internal Fuel Tank System**

## Refueling Procedure:

### **! WARNING - RESPIRATORY HAZARDS**

Diesel fuel and its vapors are dangerous to your health and the surrounding environment. Avoid skin contact and/or inhaling fumes.



1. **Level Tanks** – Make sure fuel cells are level with the ground. Failure to do so will cause fuel to spill from the tank before reaching full capacity (Figure 33).

### **! CAUTION - REFUELING THE GENERATOR**

place trailer on firm level ground before refueling to prevent spilling and maximize the amount of fuel that can be pumped into the tank.

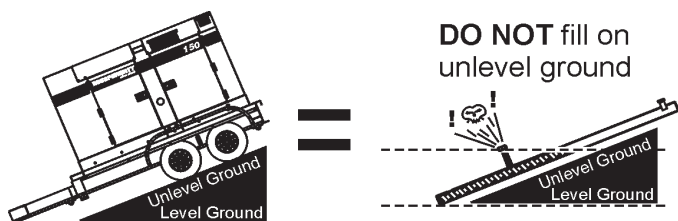
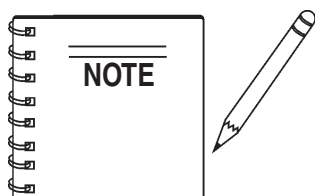

Figure 33. Only Fill on Level Ground



**ONLY!** use refueling.

when

3. Open cabinet doors on the “right side” of the generator (from generator control panel position). Remove fuel cap and fill tank (Figure 34).

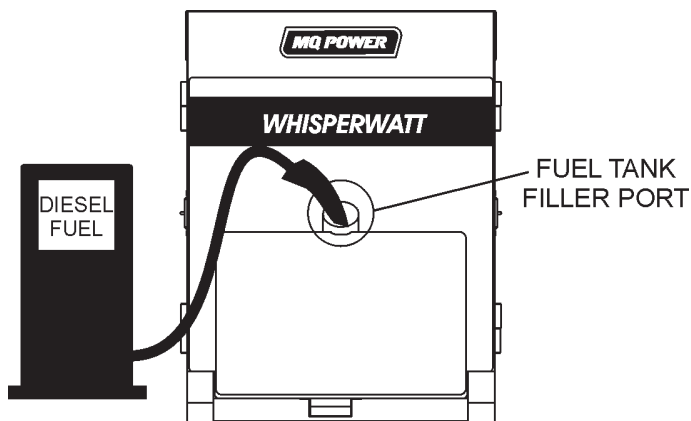

Figure 34. Fueling the Generator

3. **NEVER overfill fuel tank** – It is important to read the fuel gauge when filling trailer fuel tank. **DO NOT** wait for fuel to rise in filler neck (Figure 35).

FUEL GAUGE LOCATED ON CONTROL PANEL

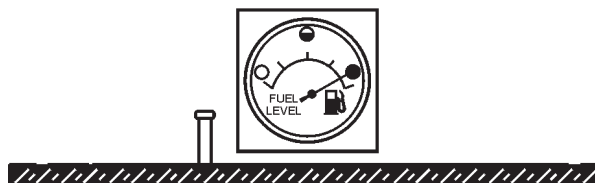

Figure 35. Full Fuel Tank

### **! CAUTION - REFUELING THE GENERATOR**

**DO NOT OVER-FILL** fuel system. Leave room for fuel expansion. Fuel expands when heated (Figure 36).



Figure 36. Fuel Expansion

## Coolant (Antifreeze)

John Deere recommends Antifreeze/Summer Coolant for use in thier engines, which can be purchased in concentrate (and mixed with 50% demineralized water) or pre-diluted. See the **John Deere Engine Owner's Manual** for further details

**! WARNING - BURN HAZARDS**

If adding coolant/antifreeze mix to the radiator, **DO NOT** remove the radiator cap until the unit has completely cooled. The possibility of coolant exists which can cause severe burns.



Day-to-day addition of coolant is done from the recovery tank. When adding coolant to the radiator, **DO NOT** remove the radiator cap until the unit has completely cooled. See Table 10 for engine, radiator, and recovery tank coolant capacities. Make sure the coolant level in the recovery tank is always between the "H" and the "L" markings.

Table 10 Coolant Capacity	
Engine and Radiator	6.3 Gal. (24 liters)
Reserve Tank	2 Quarts (1.9 liters)

## Operation Freezing Weather

When operating in freezing weather, be certain the proper amount of antifreeze (Table 11) has been added.

Table 11. Anti-Freeze Operating Temperatures				
Vol % Anti-Freeze	Freezing Point		Boiling Point	
	°C	°F	°C	°F
40	-24	-12	106	222
50	-37	-34	108	226

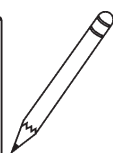
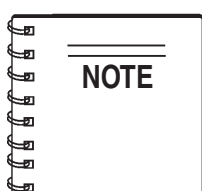

When the antifreeze is mixed with water, the antifreeze mixing ratio less than 50%.

## Cleaning the Radiator

The engine may overheat if the radiator fins become overloaded with dust or debris. Periodically clean the radiator fins with compressed air. Cleaning inside the machine is dangerous, so clean only with the engine turned off and the battery terminal disconnected.

## Air Cleaner

Periodic cleaning/replacement is necessary. Inspect it in accordance with the **John Deere Engine Owner's Manual**.

## Fan Belt Tension

A slack fan belt may contribute to overheating, or to insufficient charging of the battery. Inspect the fan belt for damage and wear and adjust it in accordance with the **John Deere Engine Owner's Manual**.

The fan belt tension is proper if the fan belt bends 10 to 15 mm (Figure 37) when depressed with the thumb as shown below.

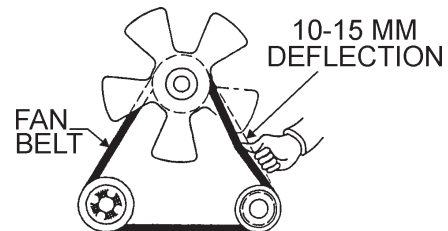



Figure 37. Fan Belt Tension

**! CAUTION - ROTATING PARTS**

**NEVER** place hands near the belts or fan while the generator set is running.

## Battery

This unit is of negative ground **DO NOT** connect in reverse. Always maintain battery fluid level between the specified marks. Battery life will be shortened, if the fluid level are not properly maintained. Add only distilled water when replenishment is necessary.

**DO NOT** over fill. Check to see whether the battery cables are loose. Poor contact may result in poor starting or malfunctions. keep the terminals firmly tightened. Coating the terminals with an approved battery terminal treatment compound. Replace battery with only recommended type battery.

The battery is sufficiently charged if the specific gravity of the battery fluid is 1.28 (at 68° F). If the specific gravity should fall to 1.245 or lower, it indicates that the battery is dead and needs to be recharged or replaced.

Before charging the battery with an external electric source, be sure to disconnect the battery cables.

### Battery Cable Installation

**ALWAYS** be sure the battery cables (Figure 38) are properly connected to the battery terminals as shown below. The **Red Cable** is connected to the positive terminal of the battery, and the **Black Cable** is connected to the negative terminal of the battery.

**⚠ CAUTION - BATTERY SERVICING SAFETY**

disconnect the negative terminal **FIRST** and reconnect negative terminal **LAST**.

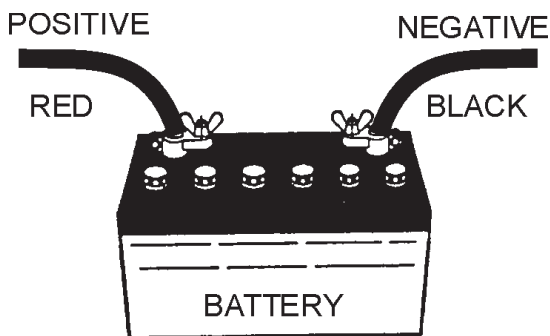

**Figure 38. Battery Connections**

When connecting battery do the following:

1. **NEVER** connect the battery cables to the battery terminals when the is in either the **MANUAL** or **AUTO** position. **ALWAYS** make sure that the is in the **OFF/RESET** position when connecting the battery.
2. Place a small amount of battery terminal treatment compound around both battery terminals. This will ensure a good connection and will help prevent corrosion around the battery terminals.

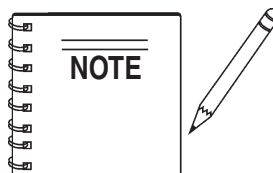

If the battery cable is connected incorrectly, electrical damage to the generator will occur. Pay close attention to the polarity of the battery when connecting the battery.

**⚠ CAUTION - BATTERY SERVICING SAFETY**

Inadequate battery connections may cause poor starting of the generator, and create other malfunctions.

### Alternator

The polarity of the alternator is negative grounding type. When an inverted circuit connection takes place, the circuit will be in short circuit instantaneously resulting the alternator failure.

**DO NOT** put water directly on the alternator. Entry of water into the alternator can cause corrosion and damage the alternator.

### Wiring

Inspect the entire generator for bad or worn electrical wiring or connections. If any wiring or connections are exposed (insulation missing) replace wiring immediately.

### Piping and Hose Connection

Inspect all piping, oil hose, and fuel hose connections for wear and tightness. Tighten all hose clamps and check hoses for leaks.

If any hose ( or ) lines are defective replace them immediately.

# GENERATOR START-UP PROCEDURE (MANUAL)

## Before Starting

**⚠ CAUTION - LETHAL EXHAUST HAZARD**

The engine's exhaust contains harmful emissions.  
Direct exhaust away from nearby personnel.

**⚠ WARNING - STARTING THE GENERATOR**

manually start the engine with the \_\_\_\_\_, or  
circuit breakers in the **ON** (closed) position.

The Engine Control Unit (ECU) used with this generator diagnosis engine faults that arise with the the engine control system and the engine itself. Engine faults can be determined by viewing the Diagnostic Trouble Codes (Active Fault Codes) which are displayed on the Diagnostic Display Panel located inside the Control Box.

1. Before starting the engine, make sure the diagnostic switch (Figure 39) on the Diagnostic Display Panel Assembly is in the "OFF" position.

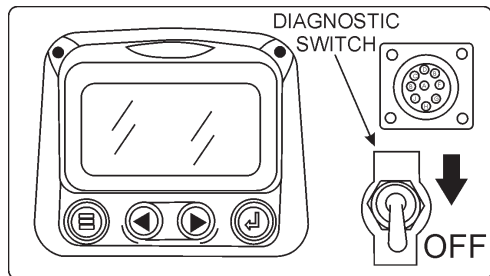

Figure 39. Diagnostic Switch (OFF position)

2. Place the \_\_\_\_\_ and \_\_\_\_\_ circuit breakers (Figure 40) in the **OFF** position prior to starting the engine.

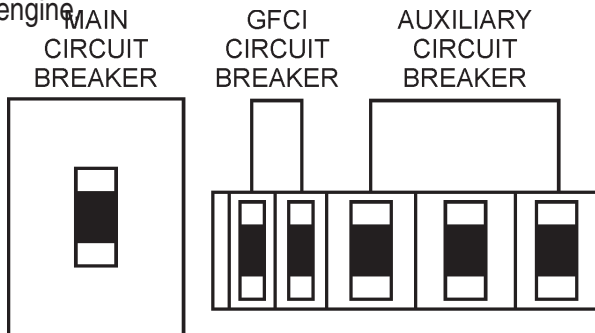
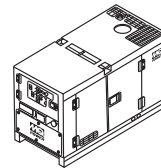
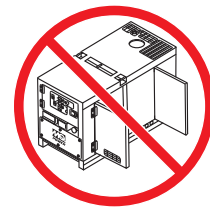

Figure 40. Main, Aux. and GFCI Circuit Breakers (OFF)

3. Make sure the the **voltage change-over board** has been configured for the desired output voltage.
4. Connect the load to the \_\_\_\_\_ or the \_\_\_\_\_ as shown in Figure 14. These load connection points can be found on the output terminal panel and the output terminal panel's hard wire hookup panel.
5. The output terminal lugs are protected by a plastic cover. Remove this cover to gain access to the terminals. Tighten terminal nuts securely to prevent load wires from slipping out.
6. Close all engine enclosure doors (Figure 41).



CORRECT



INCORRECT

Figure 41. Engine Enclosure Doors

## Starting (Manual)

1. Place the engine speed switch (Figure 42) in the "**LOW**" (down) position



Figure 42. Engine Speed Switch (Low)

2. Place the \_\_\_\_\_ in the **MANUAL** position to start the engine (Figure 43). Observe that the Warning and Emergency Stop lamps on the Engine Operating Panel are lit during the initial starting of the engine. If no abnormal conditions exists, both lamps will turn off.



Figure 43. MPEC Control Switch (Manual Position)



# GENERATOR START-UP PROCEDURE (MANUAL)

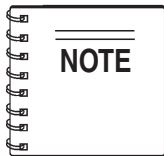

When the MPEC Control switch is placed in the manual position, preheating of the glow plugs will begin automatically and the preheat lamp will stay lit until

the glow plugs are warmed. When the preheat lamp goes off this signals the completion of the preheating cycle and the starting of the engine.

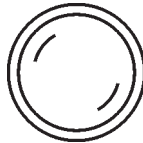

**Preheat Lamp**

- If any abnormalities exist, the Warning and Emergency Stop lamps on the Engine Operating Panel will be lit.
- Place the MPEC Control switch (Figure 43) in the **OFF/RESET** position.
- Place the Diagnostic ON/OFF switch in the **ON** position. Verify that an Active Fault Code message is being displayed (Diagnostic Display Panel). The fault code message will continue to be displayed until the fault has been corrected. Figure 44 shown below is a typical example of an active fault code message (Low Radiator Coolant).

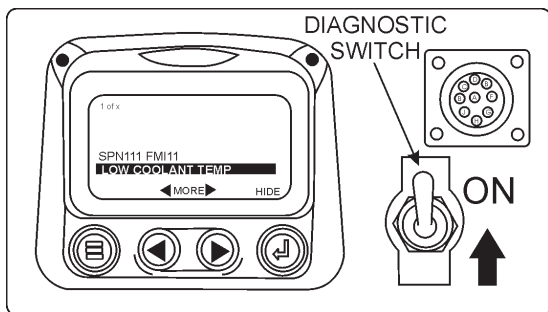

**Figure 44. Active Fault Code Message**

- In a situation where several engine problems occur simultaneously, the word **"MORE"** appears above the arrow buttons indicating that there are more fault codes that need to be viewed. Use the arrow buttons to scroll to the next active fault code.  
If desired, the type of fault code, cause of error and the countermeasures of the error can be referenced in a separate engine operator's manual.
- Before the engine can be started, the engine fault must be corrected. Also observe that there are no active fault codes displayed on the diagnostic panel. If no fault codes are displayed, place the diagnostic switch in the **OFF** position.

- To restart the engine due to error codes, place the MPEC Control switch in the **MANUAL** position (Figure 43)
- If the engine is running smoothly, place the engine speed switch (Figure 45) in the " " (up) position.



**Figure 45. Engine Speed Switch (High)**

- Verify that the **Engine Running** status LED on the MPEC unit (Figure 46) is **ON** (lit) after the engine has been started.



**Figure 46. Engine Running LED (ON)**

- Observe that the Warning and Emergency Stop lamps on the Engine Operating Panel are **OFF**.
- The generator's frequency meter (Figure 47) should be displaying the 60 cycle output frequency in **HERTZ**.

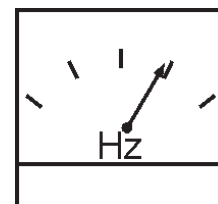

**Figure 47. Frequency Meter (Hz)**

- The generator's AC-voltmeter (Figure 48) will display the generator's output in **VOLTS**. If the voltage is not within the specified tolerance, use the voltage adjustment control knob (Figure 49) to increase or decrease the desired voltage.

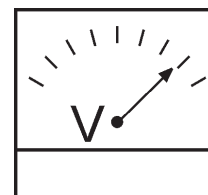

**Figure 48. Voltmeter**

# GENERATOR START-UP PROCEDURE (MANUAL)



**Figure 49. Voltage Adjust Control Knob**

14. The ammeter (Figure 50) will indicate \_\_\_\_\_ with no load applied. When a load is applied, the ammeter will indicate the amount of current that the load is drawing from the generator.

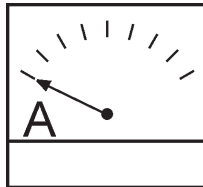

**Figure 50. Ammeter (No Load)**

15. The engine oil pressure gauge (Figure 51) will indicate the oil pressure of the engine. Under normal operating conditions the oil pressure is approximately 35 to 65 psi. (241~448 kPa). When starting the generator

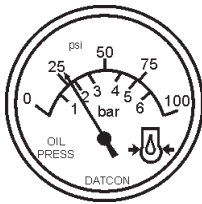

**Figure 51. Oil Pressure Gauge**

16. The \_\_\_\_\_ (Figure 52) will indicate the coolant temperature. Under normal operating conditions the coolant temperature should be between 180~230°F (82~110 °C)

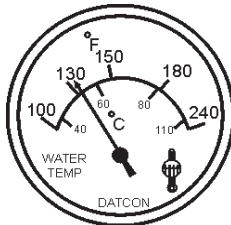

**Figure 52. Coolant Temperature Gauge**

17. The \_\_\_\_\_ (Figure 53) will indicate the speed of the engine when the generator is operating. Under normal operating conditions this speed is approximately 1800 RPM's.

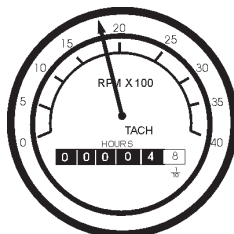

**Figure 53. Engine Tachometer Gauge**

18. Place the \_\_\_\_\_, \_\_\_\_\_, and \_\_\_\_\_ circuit breakers in the **ON** position (Figure 54).

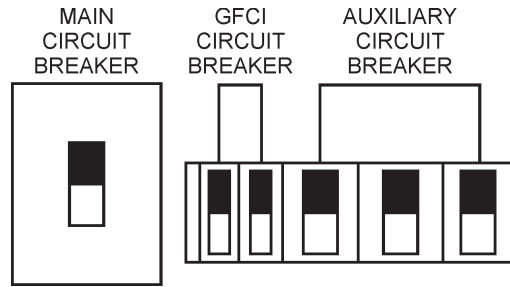

**Figure 54. Main, Aux. and GFCI Circuit Breakers (ON)**

19. Observe the generator's ammeter (Figure 55) and verify it reads the anticipated amount of current with respect to the load. The ammeter will only display a current reading if a load is in use.

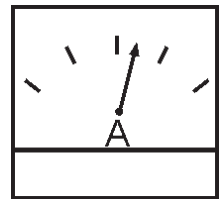

**Figure 55. Ammeter (Load)**

20. The generator will run until manually stopped or an abnormal condition occurs.

## Starting (Auto Mode)

**! DANGER - ELECTRICAL SYSTEM HAZARDS**

Before connecting this generator to any building's electrical system, a \_\_\_\_\_ must install an \_\_\_\_\_. Serious damage to the building's electrical system may occur without this transfer switch.



**! CAUTION - BACKUP GENERATOR USE**

When connecting the generator to a isolation (transfer) switch, **ALWAYS** have power applied to the generator's internal battery charger. This will ensure that the engine will not fail due to a dead battery.

When the generator is set in the **AUTO** mode, the generator will \_\_\_\_\_ in the event of commercial power falling below a prescribed level by means of a contact closure that is generated automatically by a transfer switch.

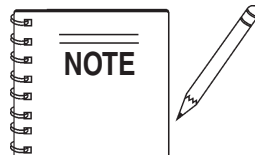

# GENERATOR START-UP PROCEDURE (AUTO MODE)

## WARNING - AUTO MODE MAINTENANCE

When running the generator in the **AUTO** mode, remember the generator can start up at any time without warning. **NEVER** attempt to perform any maintenance when the generator is in the auto mode.

## CAUTION - ENGINE SPEED SWITCH

The \_\_\_\_\_ must be set to the “**High**” position when running in the \_\_\_\_\_ mode. Failing to set the switch in the proper position can result in damage to your generator when it turns on.

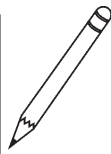
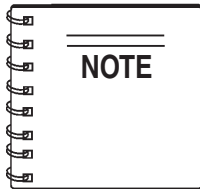

When the **MPEC** is placed in the **AUTO** position, the engine glow plugs will be warmed and the engine will start automatically.

When starting generator in **AUTO** mode use the “**Start-up**” procedure except where noted (see below).

1. Perform steps 1 through 6 in the \_\_\_\_\_ section as outlined in the \_\_\_\_\_.
2. Place the \_\_\_\_\_ (Figure 56) in the **HIGH** position



**Figure 56. Engine Speed Switch (High)**

3. Place the \_\_\_\_\_ (Figure 57) in the **AUTO** position



**Figure 57. MPEC Control Switch (AUTO)**

4. Continue operating the generator as s outlined in the procedure (start at step 5).

# GENERATOR SHUT-DOWN PROCEDURES

## **! WARNING - SHUTTING DOWN THE**

**NEVER** stop the engine suddenly except in an emergency.

## **! CAUTION - DIAGNOSTIC SWITCH**

**ALWAYS** make sure the diagnostic switch is placed in the **OFF** position before attempting to shut down the generator. The **OFF/RESET** switch on the MEC controller will not shut down the generator if the diagnostic switch is left in the **ON** position.

## Emergency Shutdown Procedure

To shutdown the generator in the event of an emergency use the following procedure:

1. Place the \_\_\_\_\_ (Figure 59) in the **OFF/RESET** position.

## Normal Shutdown Procedure

To shutdown the generator use the following procedure:

1. Place both the **MAIN**, **GFCI** and **LOAD** circuit breakers as shown in Figure 40 to the **OFF** position.
2. Place the engine speed switch (Figure 58) in the “  
” (down) position.



**Figure 58. Engine Speed Switch (Low)**

3. Let the engine cool by running it at low speed for 3-5 minutes with no load applied.
4. Place the \_\_\_\_\_ (Figure 59) to the **OFF/RESET** position.



**Figure 59. MPEC Control Switch (Off/Reset)**

5. Verify that the \_\_\_ status LED on the MPEC display are **OFF** (not lit).
6. Remove all loads from the generator.
7. Inspect entire generator for any damage or loosening of components that may have occurred during operation.

# MAINTENANCE (ENGINE)

TABLE 12. INSPECTION/MAINTENANCE		10 Hrs DAILY	250 Hrs	500 Hrs	1000 Hrs
<b>ENGINE</b>	Check Engine Fluid Levels	X			
	Check Air Cleaner	X			
	Check Battery Acid Level	X			
	Check Fan Belt Condition	X			
	Check for Leaks	X			
	Check for Loosening of Parts	X			
	Replace Engine Oil and Filter * 1		X		
	Clean Air Filter		X		
	Check Fuel Filter/Water Separator Bowl	X			
	Clean Unit, Inside and Outside		X		
	Change Fuel Filter			X	
	Clean Radiator and Check Coolant Protection Level*2			X	
	Replace Air Filter Element * 3			X	
	Check all Hoses and Clamps * 4				X
	Clean Inside of Fuel Tank				X
<b>GENERATOR</b>	Measure Insulation Resistance Over 3M ohms		X		
	Check Rotor Rear Support Bearing			X	

\*1 Replace engine oil and filter at 100 hours, first time only.

\*2 Add "Supplemental Coolant Additives (SCA'S)" to recharge the engine coolant.

\*3 Replace primary air filter element when restriction indicator shows a vacuum of 625 mm (25 in. H<sub>2</sub>O).

\*4 If blowby hose needs to be replaced, ensure that the slope of the blowby hose is at least a 1/2 inch per foot, with no sags or dips that could collect moisture and/or oil.

## General Inspection

Prior to each use, the generator should be cleaned and inspected for deficiencies. Check for loose, missing or damaged nuts, bolts or other fasteners. Also check for fuel, oil, and coolant leaks. Use Table 14 as a general maintenance guideline **Engine Side** (Refer to the Engine Instruction Manual)

### Air Cleaner

Every 250 hours: Remove air cleaner element and clean the heavy duty paper element with light spray of compressed air. Replace the air cleaner as needed.

### Air Cleaner with Dust Indicator

This indicator is attached to the air cleaner. When the air cleaner element is clogged, air intake restriction becomes greater and the dust indicator signal shows **RED** meaning the element needs changing or service. After changing the air element, press the dust indicator button to reset the indicator.

## Service Daily

If the engine is operating in very or conditions, a clogged air cleaner will result. This can lead to a loss of power, excessive carbon buildup in the combustion chamber and high fuel consumption. Change air cleaner more if these conditions exist.

### Fuel Addition

Add diesel fuel (the grade may vary according to season and locations).

### Removing Water from the Fuel Tank

After prolonged use, water and other impurities accumulate in the bottom of the tank. Occasionally inspect the fuel tank for water contamination and drain the contents if required.

During cold weather, the more empty volume inside the tank, the easier it is for water to condense. This can be reduced by keeping the tank full with diesel fuel.

# MAINTENANCE (ENGINE)

## Air Removal

If air enters the fuel injection system of a diesel engine, starting becomes impossible. After running out of fuel, or after disassembling the fuel system, bleed the system according to the following procedure. See the for details.

To restart after running out of fuel, turn the switch to the "ON" position for 15-30 seconds. Try again, if needed. This unit is equipped with an automatic air bleeding system.

## Check Oil Level

Check the crankcase oil level prior to each use, or when the fuel tank is filled. Insufficient oil may cause severe damage to the engine. Make sure the generator is level. The oil level must be between the two notches on the dipstick as shown in Figure 31.

## Replacing Oil Filter

- Remove the old oil filter.
- Apply a film of oil to the gasket on the new oil filter.
- Install the new oil filter.
- After the oil cartridge has been replaced, the engine oil will drop slightly. Run the engine for a while and check for leaks before adding more oil if needed. Clean excessive oil from engine.

## Cleaning the Fuel Strainer

Clean the fuel strainer if it contains dust or water. Remove dust or water in the strainer cap and wash it in gasoline. Securely fasten the fuel strainer cap so that fuel will not leak. Check the fuel strainer every 200 hours of operation or once a month.

## Replacing Fuel Filter

- Replace the fuel filter cartridge with new one every 500 hours or so.
- Loosen the drain plug at the lower top of the fuel filter. Drain the fuel in the fuel body together with the mixed water. **DO NOT** spill the fuel during disassembly.
- Vent any air.

## Flushing Out Radiator and Replacing Coolant

- Open both cocks located at the crankcase side and at the lower part of the radiator and drain coolant. Open the radiator cap while draining. Remove the overflow tank and drain.
- Check hoses for softening and kinks. Check clamps for signs of leakage.
- Flush the radiator by running clean tap water through radiator until signs of rust and dirt are removed. **DO NOT** clean radiator core with any objects, such as a screwdriver.
- Tighten both cocks and replace the overflow tank.
- Replace with coolant as recommended by the engine manufacturer.
- Close radiator cap tightly.

### WARNING - BURN HAZARDS

Allow engine to \_\_\_\_ when flushing out radiator. Flushing the radiator while hot could cause serious burns from water or steam.



## Generator Storage

For long term storage of the generator the following is recommended:

- Fill the fuel tank completely. Treat with a fuel stabilizer if necessary.
- Completely drain the oil from the crankcase and refill if necessary with fresh oil.
- Clean the entire generator, internal and external.
- Cover the generating set and store in a clean, dry place.
- Disconnect the battery.
- Make sure engine coolant is at proper level.
- If generator is mounted on a trailer, jack trailer up and place on blocks so tires do not touch the ground or block and completely remove the tires.



# MAINTENANCE (HEATER/CHARGER)

## Jacket Water Heater and Internal Battery Charger 120 VAC Input Receptacles (OPTIONAL)

This generator can be optionally equipped with two 120 VAC, 20 amp input receptacles located on the output terminal panel.

The purpose of these receptacles is to provide power via commercial power to the \_\_\_\_\_ and \_\_\_\_\_

These receptacles will **ONLY** function when commercial power has been supplied to them (Figure 60). To apply commercial power to these receptacles, a power cord of adequate size will be required (See Table 6).

When using the generator in \_\_\_\_\_ climates there is no reason to apply power to jacket water heater. However, if the generator will be used in \_\_\_\_\_ climates it is always a good idea to apply power to the jacket water heater at all times. To apply power to the jacket water heater simply apply power to the jacket water heater receptacle via commercial power using an power cord of adequate size.

If the generator will be used daily, the battery should normally not require charging. If the generator will be idle (not used) for long periods of time, apply power to the battery charger receptacle via commercial power using an power cord of adequate size.

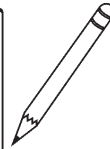
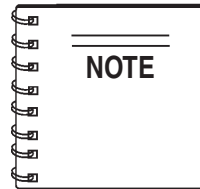

To ensure adequate starting capability, **always** have power applied to the generator's \_\_\_\_\_

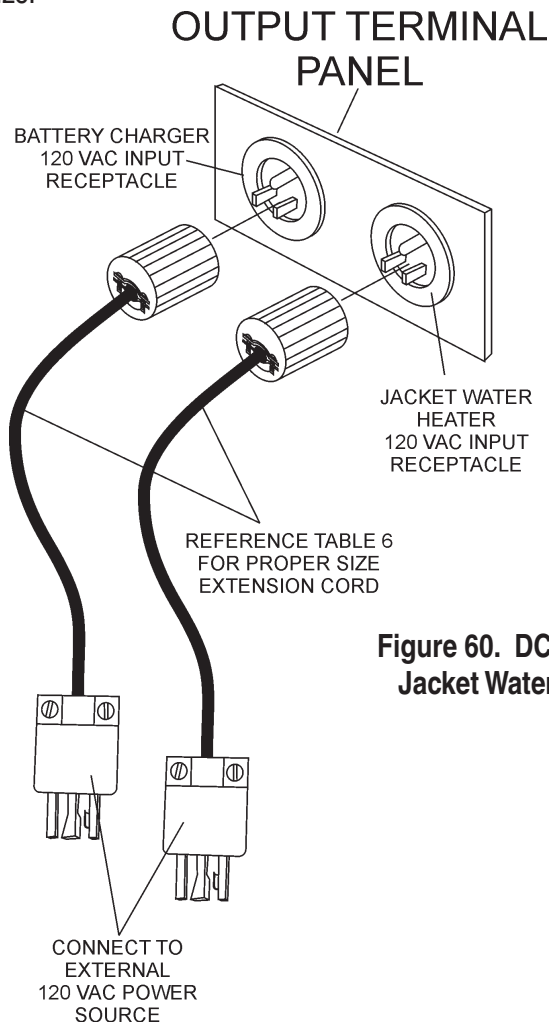

**Figure 60. DCA-180SSJUBattery Charger & Jacket Water Heater Power Connections**

## MAINTENANCE (TRAILER)

---

### Trailer Maintenance

This section is intended to provide the user with generic trailer service and maintenance information. The service and maintenance guidelines referenced in this section refer to a wide range of trailers.

Remember periodic inspection of the trailer will ensure safe towing of the generator and will prevent personal injury and damage to the equipment.

The definitions below describe some of the major components of a typical trailer that would be used with the DCA-180SSJU *Whisperwatt™* Generator.

1. **Fuel Cell** - Provides an adequate amount of fuel for the equipment in use. Fuel cells must be empty when transporting equipment.
2. **Braking System** - System employed in stopping the trailer. Typical braking systems are electric, surge, hydraulic, hydraulic-surge and air.
3. **GVWR**- Gross Vehicle Weight Rating (GVWR) is the maximum number of pounds the trailer can carry, including the fuel cell (empty).
4. **Frame Length** - Measurement is from the ball hitch to the rear bumper (reflector).
5. **Frame Width** - Measurement is from fender to fender
6. **Jack Stand** - Trailer support device with maximum pound requirement from the tongue of the trailer.
7. **Coupler** - Type of hitch used on the trailer for towing.
8. **Tire Size** - Indicates the diameter of the tire in inches (10,12,14, etc.), and the width in millimeters (175,185,205, etc.). The tire diameter must match the diameter of the tire rim.
9. **Tire Ply** - The tire ply (layers) number is rated in letters; 2-ply,4-ply,6-ply, etc.
10. **Wheel Hub** - The wheel hub is connected to the trailer's axle.
11. **Tire Rim** - Tires mounted on a tire rim. The tire rim must match the size of the tire.
12. **Lug Nuts** - Used to secure the wheel to the wheel hub. Always use a torque wrench to tighten down the lug nuts. See Table 18 and Figure 63 for lug nut tightening and sequence.
13. **Axle** - Indicates the maximum weight the axle can support in pounds, and the diameter of the axle expressed in inches. Please note that some trailers have a double axle. This will be shown as 2-6000 lbs., meaning two axles with a total weight capacity of 6000 pounds.
14. **Suspension** - Protects the trailer chassis from shocks transmitted through the wheels. Types of suspension used are leaf, Q-flex, and air ride.
15. **Electrical** - Electrical connectors (looms) are provided with the trailer so the brake lights and turn signals can be connected to the towing vehicle.
16. **Application** - Indicates which units can be employed on a particular trailer.

# MAINTENANCE (TRAILER)

## Brakes

Trailer brakes should be inspected the of operation. This will allow the brake shoes and drums to seat properly. After the first 200 mile interval, inspect the brakes . If driving over rough terrain, inspect the brakes more frequently.

Figure 61 displays the major hydraulic surge brake components that will require inspection and maintenance. Please inspect these components as required using steps 1 through 8 and Table 15 as listed below:

### Brake Adjustment

1. Place the trailer on jack stands. Make sure the jack stands are placed on secure level ground.
2. Check the wheel and drum for free rotation.
3. Remove the adjusting hole cover from the adjusting slot at the bottom brake backing plate.
4. With a screwdriver or standard adjusting tool, rotate the star wheel of the adjuster assembly to expand the brake shoes.
5. Adjust the brake shoes outward until the pressure of the lining against the wheel drum makes the wheel difficult to turn.
6. Adjust, rotate the star wheel in the opposite direction until the wheel rotates freely with slight lining drag.
7. Replace the adjusting hole cover and lower the trailer to the ground.
8. Repeat steps 1 through 7 on the remaining brakes.

## Hydraulic Surge Brakes

Hydraulic surge brakes (Figure 61) should not require any special attention with the exception of routine maintenance such as shoe and lining replacement. Brake lines should be periodically checked for cracks, kinks, or blockage.

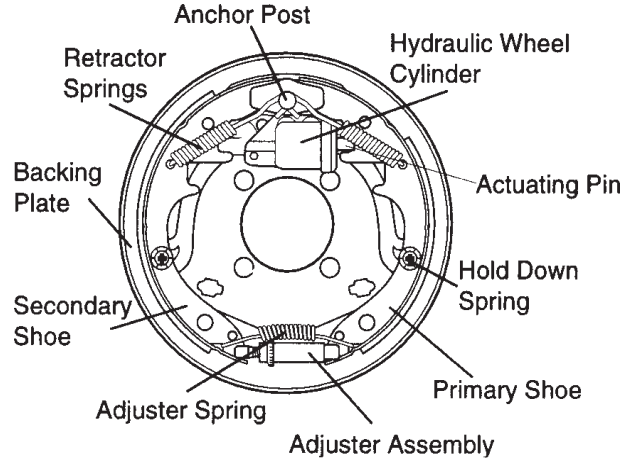

**Figure 61. Hydraulic Brake Components**

### Actuator

Hydraulic surge braking requires the installation of an actuator at the tongue of the trailer. Remember the or of the trailer toward the tow vehicle automatically synchronizes the trailer brakes with the tow vehicle brakes. As the trailer pushes against the tow vehicle the actuator telescopes together and applies force to the master cylinder, supplying hydraulic pressure to the trailer brakes.

Periodically check and test the surge “ ” to make sure that it is functioning correctly. Never use an undersize actuator.

**Table 13. Hydraulic Brake Troubleshooting**

Symptom	Possible Cause	Solution
No Brakes	Brake line broken or kinked?	Repair or replace.
Weak Brakes or Brakes Pull to One Side	Brake lining glazed?	Reburnish or replace.
	Trailer overloaded?	Correct weight.
	Brake drums scored or grooved?	Machine or replace.
	Tire pressure correct?	Inflate all tires equally.
	Tires unmatched on the same axle?	Match tires.
Locking Brakes	Brake components loose, bent or broken?	Replace components.
	Brake drums out-of-round?	Replace.
Noisy Brakes	System lubricated?	Lubricate.
	Brake components correct?	Replace and correct.
Dragging Brakes	Brake lining thickness incorrect or not adjusted correctly?	Install new shoes and linings.
	Enough brake fluid or correct fluid?	Replace rubber parts fill with dot 4 fluid.

# MAINTENANCE (TRAILER)

## Tires/Wheels/Lug Nuts

Tires and wheels are a very important and critical components of the trailer. When specifying or replacing the trailer wheels it is important the wheels, tires, and axle are properly matched.

**! CAUTION - EYESIGHT HAZARD**

wear safety glasses when removing or installing force fitted parts. Failure to comply may result in serious injury.



**! CAUTION - REPAIRING TRAILER WHEELS**







**DO NOT** attempt to repair or modify a wheel. **DO NOT** install in inner tube to correct a leak through the rim. If the rim is cracked, the air pressure in the inner tube may cause pieces of the rim to explode (break off) with great force and cause serious eye or bodily injury.



## Tire Wear/Inflation

Tire inflation pressure is the most important factor in tire life. Pressure should be checked cold before operation **DO NOT** bleed air from tires when they are . Check inflation pressure weekly during use to insure the maximum tire life and tread wear.

Table 14 (Tire Wear Troubleshooting) will help pinpoint the causes and solutions of tire wear problems.

TABLE 14. TIRE WEAR TROUBLESHOOTING			
WEAR PATTERN		CAUSE	SOLUTION
	Center Wear	Over Inflation.	Adjust pressure to particular load per tire manufacturer.
	Edge Wear	Under Inflation.	Adjust pressure to particular load per tire manufacturer.
	Side Wear	Loss of camber or overloading.	Make sure load does not exceed axle rating. Align wheels.
	Toe Wear	Incorrect toe-in.	Align wheels.
	Cupping	Out-of-balance.	Check bearing adjustment and balance tires.
	Flat Spots	Wheel lockup & tire skidding.	Avoid sudden stops when possible and adjust brakes.

## Suspension

The springs and associated components (Figure 62) should be visually inspected every 6,000 miles for signs of excessive wear, elongation of bolt holes, and loosening of fasteners. Replace all damaged parts (suspension) immediately. Torqued suspension components as detailed in Table 15.

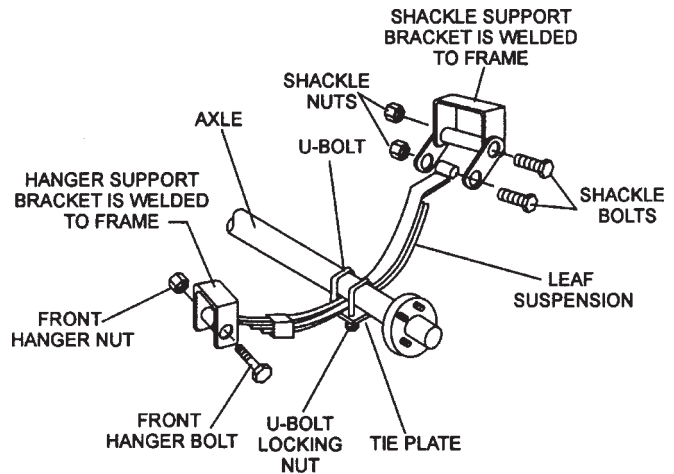

Figure 62. Major Suspension Components

Table 15. Suspension Torque Requirements

Item	Torque (Ft.-Lbs.)
3/8" U-BOLT	MIN-30 MAX-35
7/16" U-BOLT	MIN-45 MAX-60
1/2" U-BOLT	MIN-45 MAX-60
SHACKLE BOLT SPRING EYE BOLT	SNUG FIT ONLY. PARTS MUST ROTATE FREELY. LOCKING NUTS OR COTTER PINS ARE PROVIDED TO RETAIN NUT-BOLT ASSEMBLY.
SHOULDER TYPE SHACKLE BOLT	MIN-30 MAX-50

# MAINTENANCE (TRAILER)

## Lug Nut Torque Requirements

It is extremely important to apply and maintain proper wheel mounting torque on the trailer. Be sure to use only the fasteners matched to the cone angle of the wheel. Proper procedure for attachment of the wheels is as follows:

1. Start all wheel lug nuts by hand.
2. Torque all lug nuts in sequence (see Figure 63). **DO NOT** torque the wheel lug nuts all the way down. Tighten each lug nut in 3 separate passes as defined by Table 16.
3. After first road use, retorque all lug nuts in sequence. Check all wheel lug nuts periodically.

**Table 16. Tire Torque Requirements**

Wheel Size	First Pass FT-LBS	Second Pass FT-LBS	Third Pass FT-LBS
12"	20-25	35-40	50-65
13"	20-25	35-40	50-65
14"	20-25	50-60	90-120
15"	20-25	50-60	90-120
16"	20-25	50-60	90-120

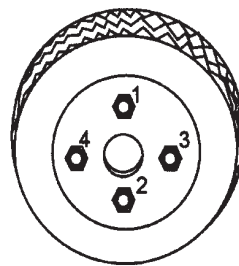

4-LUG NUTS

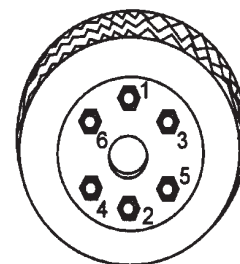

6-LUG NUTS

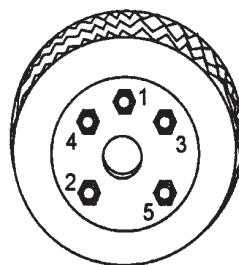

5-LUG NUTS

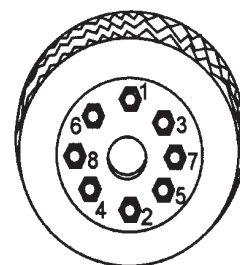

8-LUG NUTS

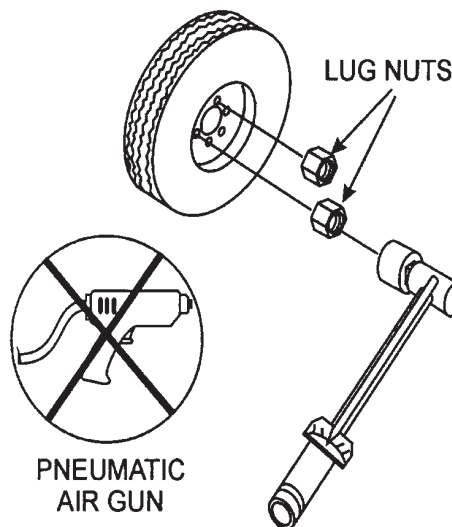

TORQUE WRENCH

**Figure 63. Wheel Lug Nuts Tightening Sequence**

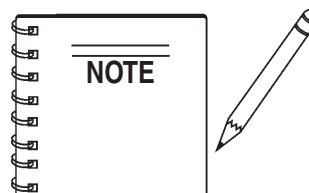

use an pneumatic air gun to tighten wheel lug nuts.

# TRAILER WIRING DIAGRAM

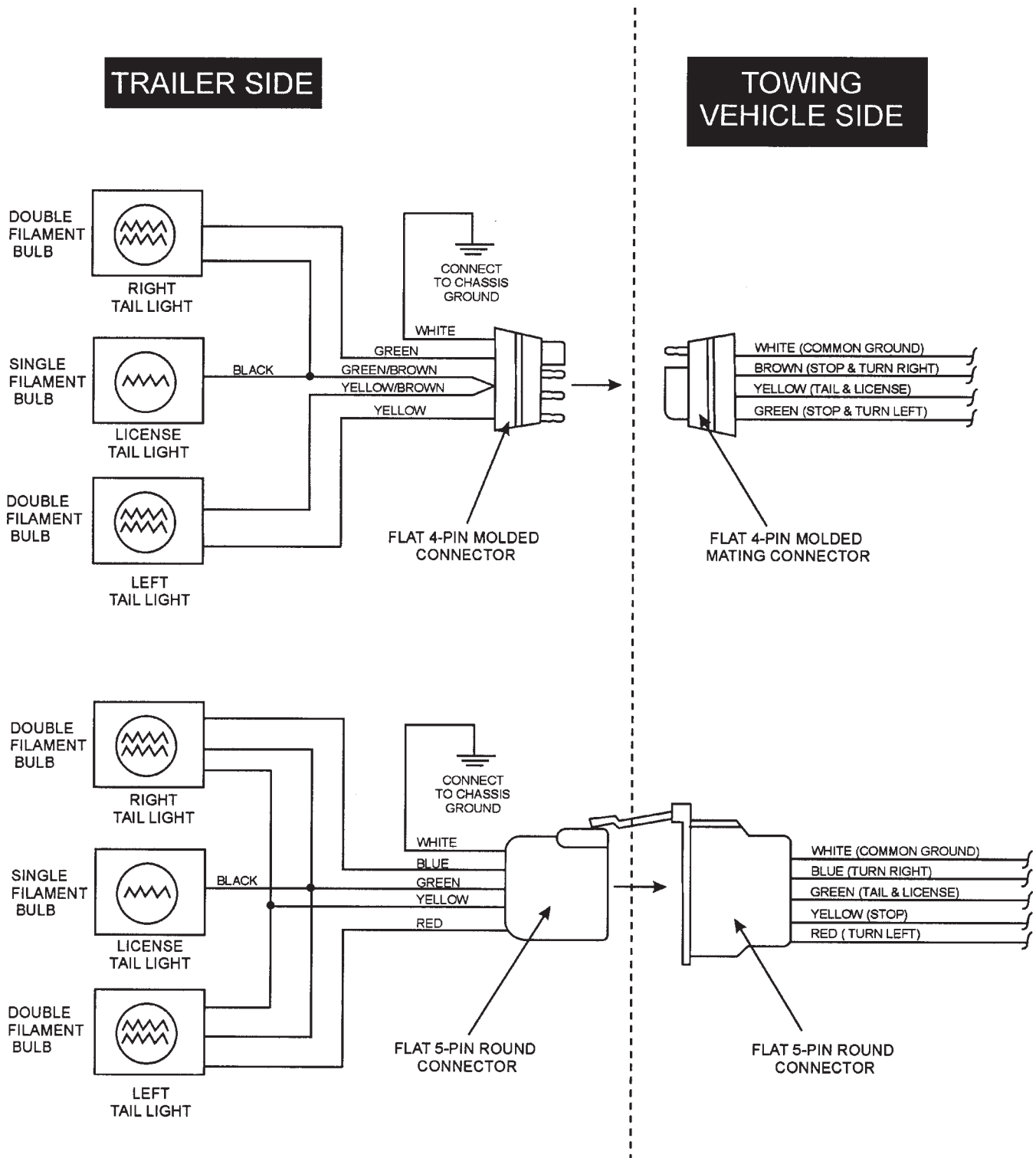
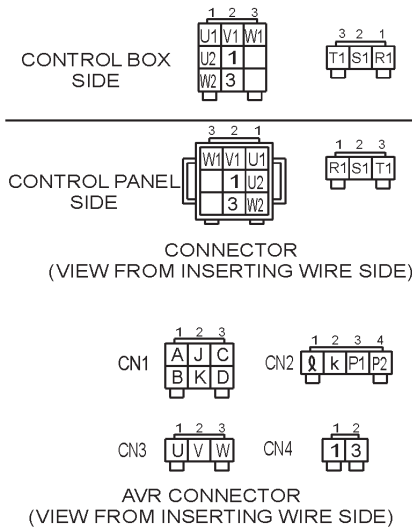
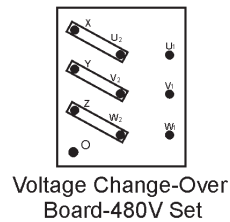
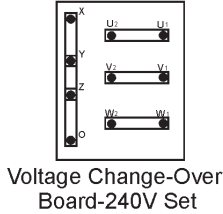
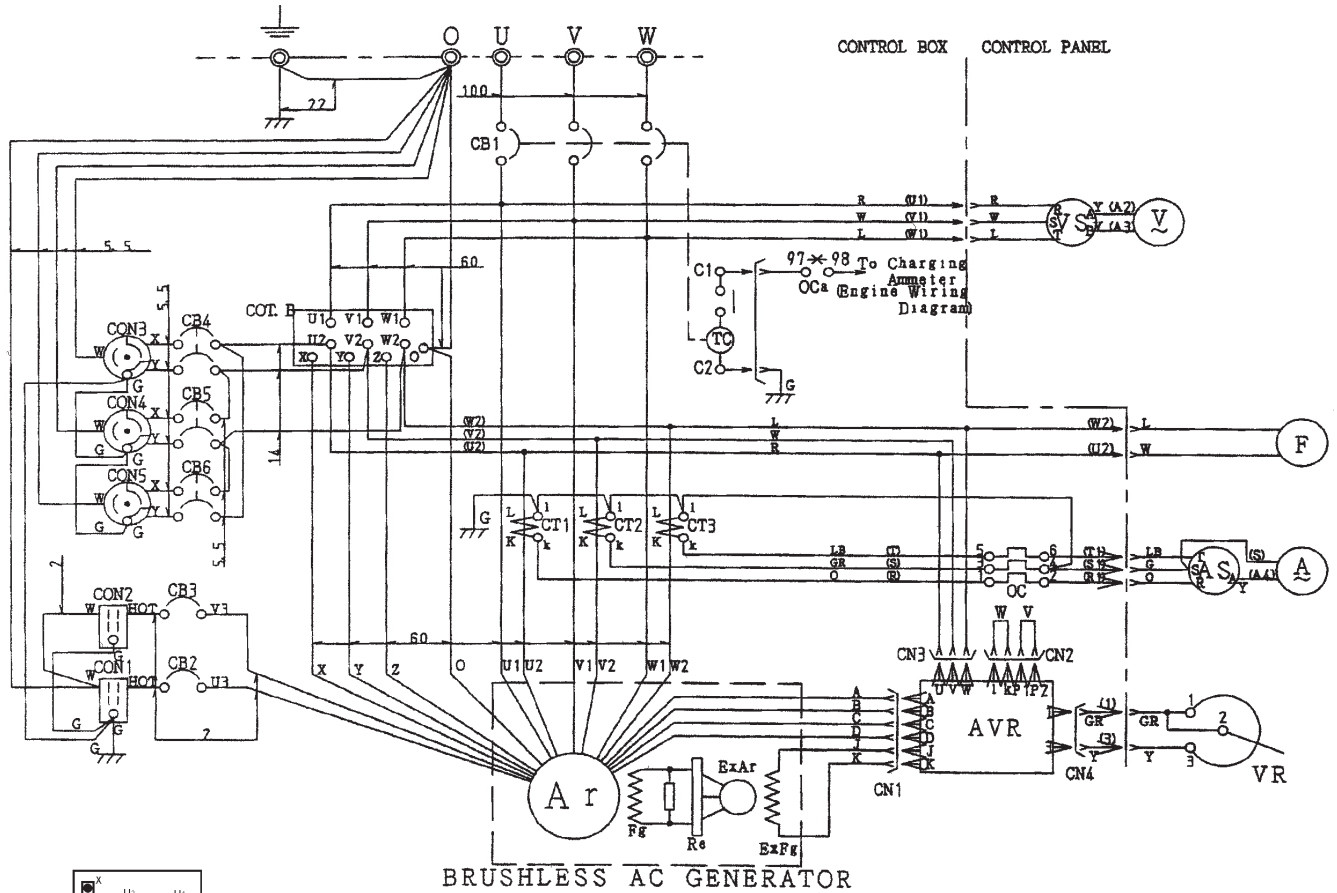

Figure 62. Trailer/Towing Vehicle Wiring Diagram



# GENERATOR WIRING DIAGRAM



SYM	DESIGNATION
Ar	Main Generator Armature Winding
Fg	Main Generator Field Winding
ExAr	Exciter Armature Winding
ExFg	Exciter Field Winding
Re	Rectifier
AVR	Automatic Voltage Regulator
VR	Voltage Regulator (Rheostat)
CT	Current Transformer (CT1 thru CT3)
AS	Change-Over Switch, Ammeter
A	Ammeter
VS	Change-Over Switch, Voltmeter
V	Voltmeter
F	Frequency Meter
CB	Circuit Breakers (CB1 thru CB6)
CON	Receptacle (CON 1 thru 6)
OC	Over Current Relay
SW1	Panel Light Switch
IL	Panel Light
COT B	Voltage Change-Over Board

COLOR CODE			
SYM.	WIRE COLOR	SYM.	WIRE COLOR
B	BLACK	R	RED
L	BLUE	W	WHITE
BR	BROWN	Y	YELLOW
G	GREEN	LB	LIGHT BLUE
GR	GRAY	LG	LIGHT GREEN
V	VIOLET	O	ORANGE
P	PINK		

Figure 63. Generator Wiring Diagram

# DCA-180SSJU — ENGINE WIRING DIAGRAM

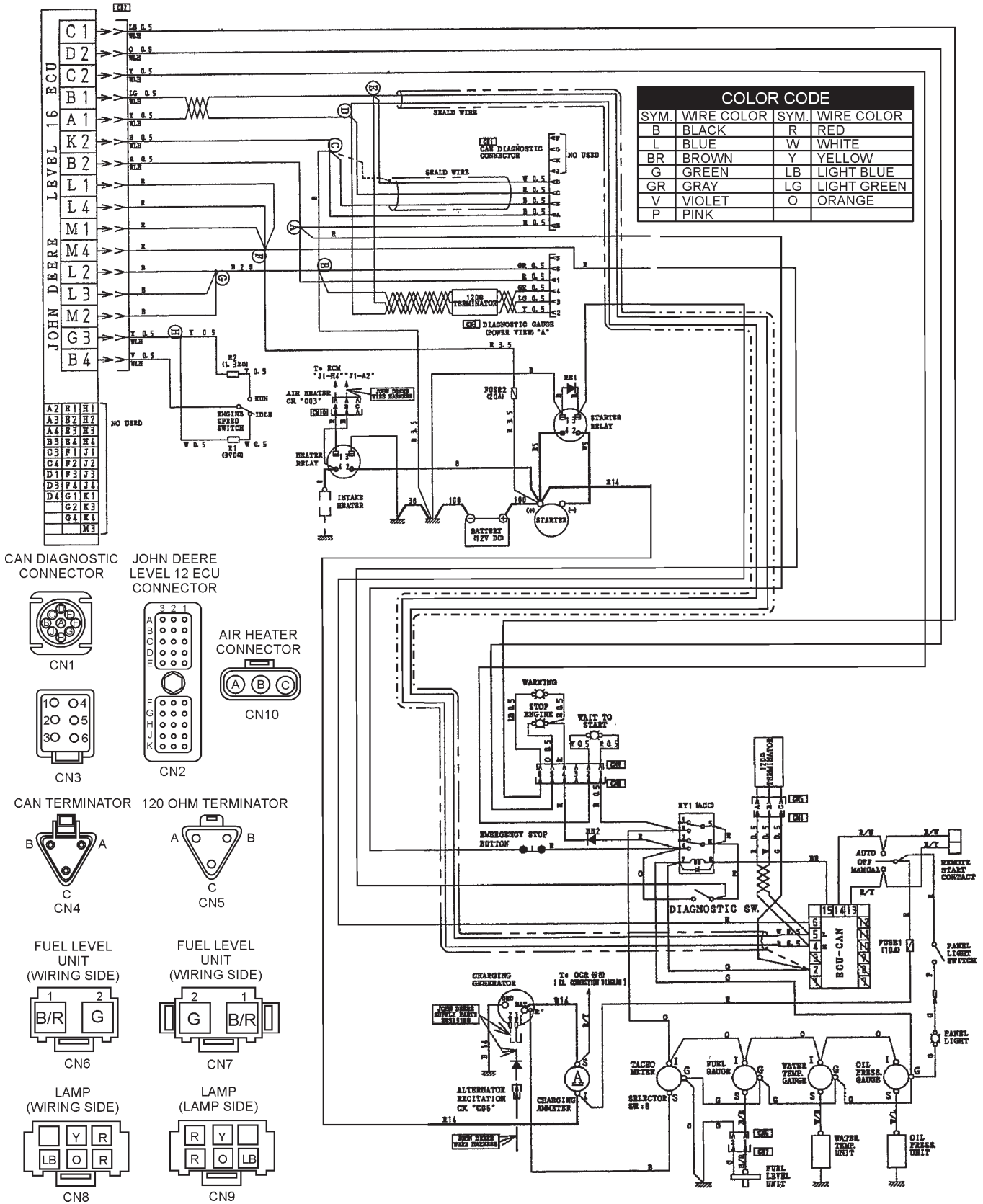

Figure 64. Engine Wiring Diagram

## TROUBLESHOOTING (GENERATOR)

Practically all breakdowns can be prevented by proper handling and maintenance inspections, but in the event of a breakdown, use Table 17 shown below for diagnosis of the Generator. If the problem cannot be remedied, consult our company's business office or service plant.

**TABLE 17. GENERATOR TROUBLESHOOTING**

SYMPTOM	POSSIBLE PROBLEM	SOLUTION
No Voltage Output	AC Voltmeter defective?	Check output voltage using a voltmeter.
	Is wiring connection loose?	Check wiring and repair.
	Is AVR defective?	Replace if necessary.
	Defective Rotating Rectifier?	Check and replace.
	Defective Exciter Field?	Check for 17.3 ohms across J & K on CN1
Low Voltage Output	Is engine speed correct?	Turn engine throttle lever to "High".
	Is wiring connections loose?	Check wiring and repair.
	Defective AVR?	Replace if necessary.
High Voltage Output	Is wiring connections loose?	Check wiring and repair.
	Defective AVR?	Replace if necessary.
Circuit Breaker Tripped	Short Circuit in load?	Check load and repair.
	Over current?	Confirm load requirements and reduce.
	Defective circuit breaker?	Check and replace.
	Over current Relay actuated?	Confirm load requirement and replace.

## TROUBLESHOOTING (ENGINE CONTROLLER)

Practically all breakdowns can be prevented by proper handling and maintenance inspections, but in the event of a breakdown, use Table 18 (Engine Controller Troubleshooting) as a basic guideline for troubleshooting the Microprocessor Engine Controller unit (MPEC). If the problem cannot be remedied, consult our company's business office or service plant.

**TABLE 18. ENGINE CONTROLLER TROUBLESHOOTING (MPEC)**

SYMPTOM	POSSIBLE PROBLEM	SOLUTION
Low oil pressure light is on.	Low oil level?	Fill oil level.
	Oil pressure sending unit failure?	Replace oil pressure sending unit.
	Time delay malfunction in Controller?	Refer to dealer.
	Wire shorted?	Inspect/repair wire.
Low coolant level light is on. (Optionally Installed)	Low coolant level?	Fill coolant level.
	Sending unit failure?	Replace sending unit.
	Low battery voltage?	Replace/charge battery.
High coolant temperature light is on.	Fan belt tension incorrect?	Tighten/replace fan belt.
	Air flow is not circulation through radiator?	Clean/repair radiator grill.
	Doors open?	Close doors.
	Exhaust leaking?	Replace/repair gaskets or faulty part.
	Generator being overloaded?	Check/reduce load.
	Thermostat failure?	Replace thermostat.
	Air intake blocked?	Clear all air intakes.
	Temperature switch failure?	Replace temperature switch.
Overcrank light is on.	No or low Fuel?	Fill fuel level.
	Controller needs to be calibrated?	Refer to dealer.
Overspeed light is on.	RPM engine speed too high?	Adjust RPM.
	Governor actuator needs to be adjusted?	Adjust governor actuator.
	Governor controller needs to be adjusted?	Adjust governor controller.
	Engine Controller needs to be calibrated?	Refer to dealer.
Loss of MPU light(s) or on.	Magnetic pick up out of adjustment?	Adjust magnetic pick up.
	Magnetic pick up dirty?	Clean magnetic pick up.



# EXPLANATION OF CODE IN REMARKS COLUMN

The following section explains the different symbols and remarks used in the Parts section of this manual. Use the help numbers found on the back page of the manual if there are any questions.

**NOTICE**

The contents and part numbers listed in the parts section are subject to change **without notice**. Multiquip does not guarantee the availability of the parts listed.

## SAMPLE PARTS LIST

NO.	PART NO.	PART NAME	QTY.	REMARKS
1	12345	BOLT.....	1	INCLUDES ITEMS W/%
2%		WASHER, 1/4 IN.....		NOT SOLD SEPARATELY
2%	12347	WASHER, 3/8 IN....	1	MQ-45T ONLY
3	12348	HOSE .....		A/R ...MAKE LOCALLY
4	12349	BEARING .....	1	S/N 2345B AND ABOVE

### NO. Column

**Unique Symbols** — All items with same unique symbol

(@, #, +, %, or >) in the number column belong to the same assembly or kit, which is indicated by a note in the “Remarks” column.

**Duplicate Item Numbers** — Duplicate numbers indicate multiple part numbers, which are in effect for the same general item, such as different size saw blade guards in use or a part that has been updated on newer versions of the same machine.

**NOTICE**

When ordering a part that has more than one item number listed, check the remarks column for help in determining the proper part to order.

### PART NO. Column

**Numbers Used** — Part numbers can be indicated by a number, a blank entry, or TBD.

TBD (To Be Determined) is generally used to show a part that has not been assigned a formal part number at the time of publication.

A blank entry generally indicates that the item is not sold separately or is not sold by Multiquip. Other entries will be clarified in the “Remarks” Column.

### QTY. Column

**Numbers Used** — Item quantity can be indicated by a number, a blank entry, or A/R.

A/R (As Required) is generally used for hoses or other parts that are sold in bulk and cut to length.

A blank entry generally indicates that the item is not sold separately. Other entries will be clarified in the “Remarks” Column.

### REMARKS Column

Some of the most common notes found in the “Remarks” Column are listed below. Other additional notes needed to describe the item can also be shown.

**Assembly/Kit** — All items on the parts list with the same unique symbol will be included when this item is purchased.

Indicated by:  
 “INCLUDES ITEMS W/(unique symbol)”

**Serial Number Break** — Used to list an effective serial number range where a particular part is used.

Indicated by:  
 “S/N XXXXX AND BELOW”  
 “S/N XXXX AND ABOVE”  
 “S/N XXXX TO S/N XXX”

**Specific Model Number Use** — Indicates that the part is used only with the specific model number or model number variant listed. It can also be used to show a part is NOT used on a specific model or model number variant.

Indicated by:  
 “XXXXX ONLY”  
 “NOT USED ON XXXX”

**“Make/Obtain Locally”** — Indicates that the part can be purchased at any hardware shop or made out of available items. Examples include battery cables, shims, and certain washers and nuts.

**“Not Sold Separately”** — Indicates that an item cannot be purchased as a separate item and is either part of an assembly/kit that can be purchased, or is not available for sale through Multiquip.

# SUGGESTED SPARE PARTS

## DCA-180SSJU WHISPER WATTGENERATOR W/JOHN DEERE 6068HF485 TURBO DIESEL ENGINE 1 TO 3 UNITS

<u>Qty.</u>	<u>P/N</u>	<u>Description</u>
1 .....	M4310500803 .....	HOSE, RADIATOR UPPER
1 .....	M4310500903 .....	HOSE, RADIATOR LOWER
1 .....	0605505070 .....	FUEL CAP
1 .....	0602015230 .....	V-BELT, FAN
1 .....	0602122272 .....	UNIT, OIL PRESSURE
1 .....	0602123263 .....	UNIT, WATER TEMPERATURE
6 .....	0602042596 .....	FILTER, FUEL PRIMARY
6 .....	0602042597 .....	FILTER, FUEL FINAL
6 .....	0602041292 .....	FILTER, OIL CARTRIDGE
3 .....	0602046683 .....	ELEMENT AIR INNER
1 .....	0601808803 .....	CIRCUIT BREAKER 1P 20A
1 .....	0601808804 .....	CIRCUIT BREAKER 2P 50A
2 .....	LY2DUS12VDC ....	RELAY
1 .....	0602123290 .....	SWITCH, COOLANT LEVEL
3 .....	0602046682 .....	ELEMENT, AIR OUTER
1 .....	0601820625 .....	AUTOMATIC VOLTAGE REGULATOR
1 .....	0601840121 .....	KNOB, AUTOMATIC VOLTAGE REGULATOR
3 .....	0601810245 .....	BULB, ALARM LAMP
1 .....	0602122272 .....	UNIT, OIL PRESSURE
1 .....	0602123263 .....	UNIT, WATER TEMPERATURE
1 .....	0601806653 .....	FUSE, 20A
1 .....	0601802149 .....	FUSE, 10A

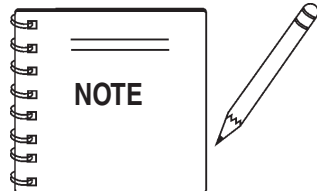

Part number on this Suggested Spare Parts list may supercede/replace the P/N shown in the text pages of this book.



# GENERATOR ASSY.

GENERATOR ASSY.

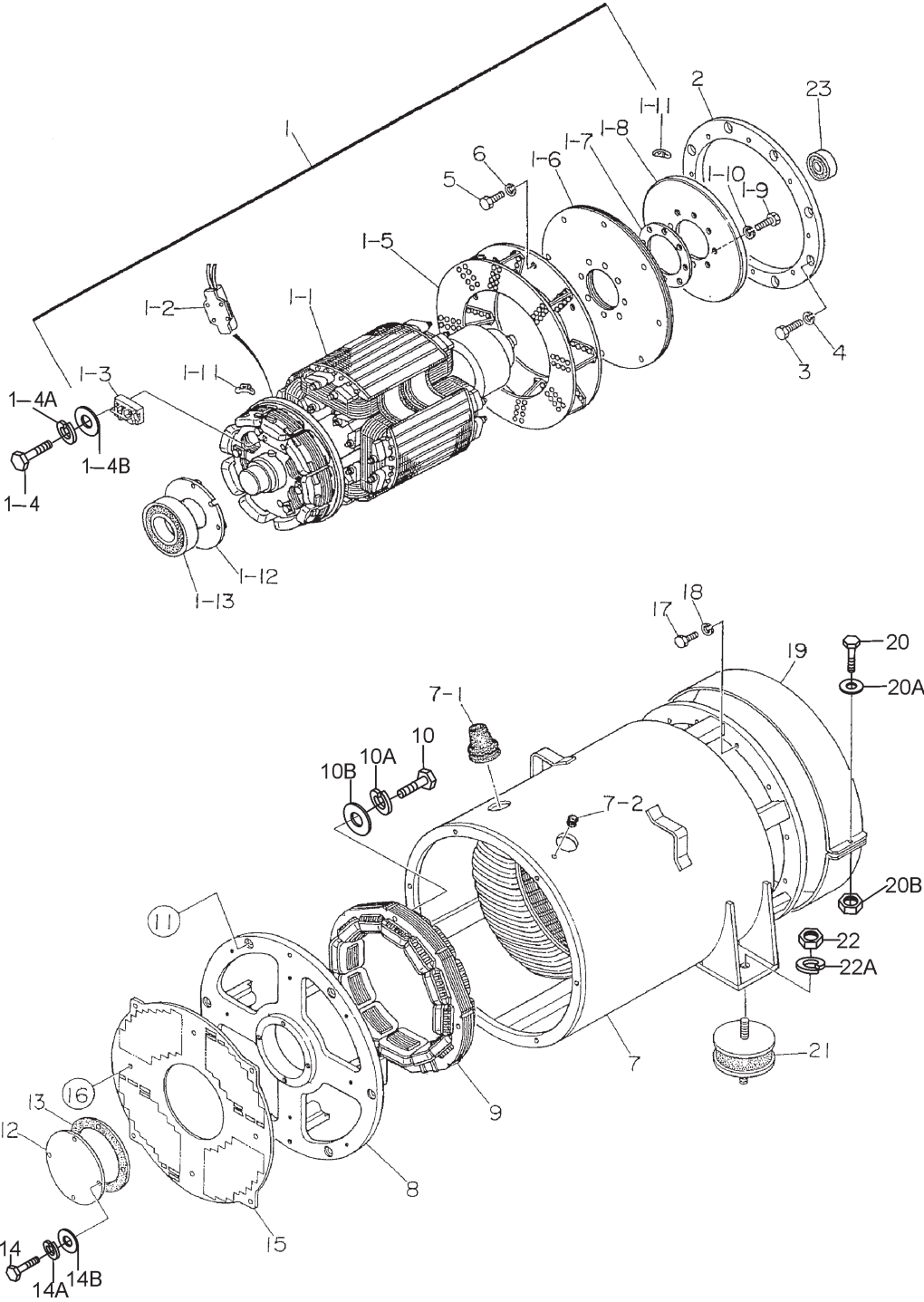

# GENERATOR ASSY.

## GENERATOR ASSY.

<u>NO.</u>	<u>PART NO.</u>	<u>PART NAME</u>	<u>QTY.</u>	<u>REMARKS</u>
1	C0110000602	ROTOR ASSY. ....	1	INCLUDES ITEMS W/#
1-1#		FIELD ASSY.....	1	NOT SOLD SEPARTELY
1-2#	0601842334	RESISTOR, 100K OHM	1	
1-3#	0601823282	RECTIFIER	1	
1-4#	0018205020	HEX. SHCS	2	
1-4A#	0040005000	WASHER, LOCK	2	
1-4B#	0041205000	WASHER, FLAT	2	
1-5#	8171070002	FAN	1	
1-6#	8171611003	COUPLING DISK	9	
1-7#	C1164200004	WASHER, COUPLING HUB	1	
1-8#	8171015003	BALANCING PLATE .....	1	PURCHASE ITEMS 1-1 THRU 1-11 AS A SET
1-9#	0012116045	HEX. HEAD BOLT	8	
1-10#	0042616000	WASHER, LOCK	8	
1-11#	0601000209	BALANCING WEIGHT KIT	1	
1-12#	C1112500004	BEARING FLANGE	1	
1-13#	0071906314	BEARING	1	
2	M4163400003	COUPLING RING	1	
3	0343206120	HEX. HEAD BOLT	8	
4	0043606000	WASHER, LOCK	8	
5	0012112040	HEX. HEAD BOLT	8	
6	0042512000	WASHER, LOCK	8	
7	C0130000703	STATOR ASSY.	1	
7-1	0845041804	GROMMET	2	
7-2	0601850144	GROMMET	1	
8	C1154000002	END BRACKET	1	
9	C1138000003	FIELD ASSY. EXCITER	1	
10	0012110065	HEX. HEAD BOLT	4	
10A	0042610000	WASHER, LOCK	4	
10B	0041210000	WASHER, FLAT	4	
11	0017112045	HEX. HEAD BOLT	6	
12	C1154400004	COVER, BEARING	1	
13	C1154300004	GASKET, BEARING	1	
14	0010106060	HEX. HEAD BOLT	4	
14A	0040006000	WASHER, LOCK	4	
14B	0041206000	WASHER, FLAT	4	
15	C1154400103	SUCTION COVER	1	
16	0017106016	HEX. HEAD BOLT	8	
17	0343205150	HEX. HEAD BOLT	12	
18	0043605000	WASHER, LOCK	12	
19	C1132300114	COVER, FAN	1	
20	0010106030	HEX. HEAD BOLT	1	
20A	0041206000	WASHER, FLAT	1	
20B	0600815000	NUT	1	
21	0605000012	RUBBER SUSPENSION	2	
22	0030020000	HEX. NUT	4	
22A	0040020000	WASHER, LOCK	4	
23	0070506307	BEARING	1	

# CONTROL PANEL ASSY.

CONTROL PANEL ASSY.

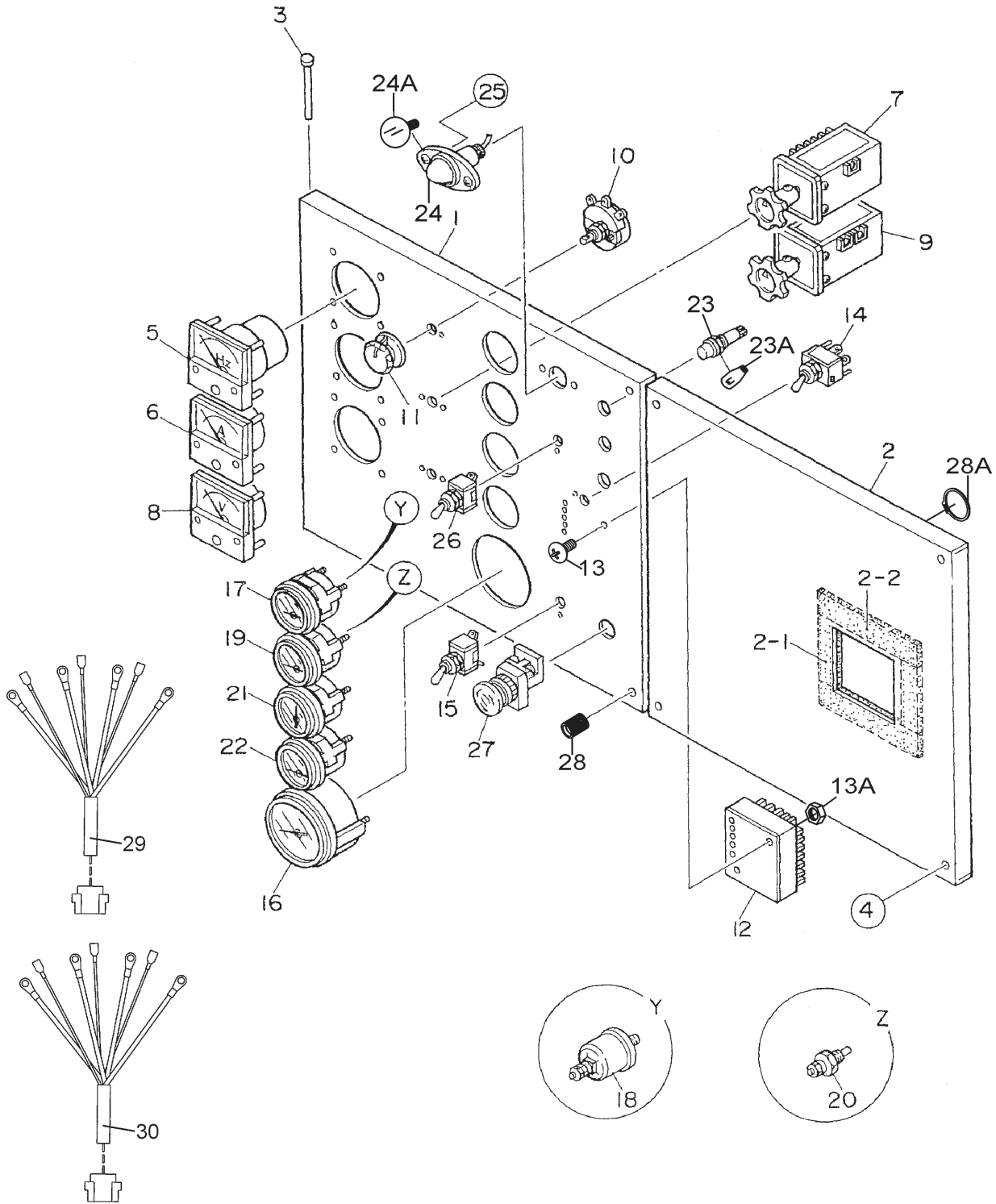

## CONTROL PANEL ASSY.

### CONTROL PANEL ASSY.

<u>NO.</u>	<u>PART NO.</u>	<u>PART NAME</u>	<u>QTY.</u>	<u>REMARKS</u>
1	M4223000303	CONTROL PANEL	1	
2	M4223000404	CONTROL PANEL	1	
2-1	022100100	SEAL RUBBER	2	
2-2	022100165	SEAL RUBBER	2	
3	0605011211	PIN	2	
4	0017108040	HEX. HEAD BOLT	4	
5	0601807642	FREQUENCY METER, 240V	1	
6	0601817000	AC AMMETER, 0~300A/600A:5A	1	
7	0601800275	CHANGE- OVER SWITCH, AMMETER	1	
8	0601800275	AC VOLTMETER, 0~600V	1	
9	0601801041	CHANGE-OVER SWITCH, VOLTMETER	1	
10	0601840073	RHEOSTAT, VOLTAGE REGULATOR	1	
11	0601840121	KNOB	1	
12	0602202593	CONTROLLER	1	
13	0027104040	MACHINE SCREW	2	
13A	0207004000	HEX. NUT	2	
14	0601831340	SWITCH	1	
15	0601831340	SWITCH	1	
16	0602120096	TACHOMETER	1	
17	0602122093	OIL PRESSURE GAUGE	1	
18	0602122272	UNIT, OIL PRESSURE	1	
19	0602123092	WATER TEMPERATURE GAUGE	1	
20	0602123263	UNIT, WATER TEMPERATURE	1	
21	0602125090	FUEL GAUGE	1	
23	0602103092	ALARM LAMP	3	
23A	0601810245	BULB	1	
24	0601810160	PANEL LIGHT	1	
24A	0601810213	HEX. NUT	2	
25	0207904000	HEX. NUT	2	
26	0601831330	SWITCH, PANEL LIGHT	1	
27	0601831557	EMERGENCY STOP BUTTON	2	
28	M9220100004	SET SCREW	2	
28A	0080200007	SNAP RING	2	
29	M3246702604	WIRE HARNESS, GENERATOR	1	
30	M4357200102	WIRE HARNESS, ENGINE	1	

# CONTROL BOX ASSY.

CONTROL BOX ASSY.

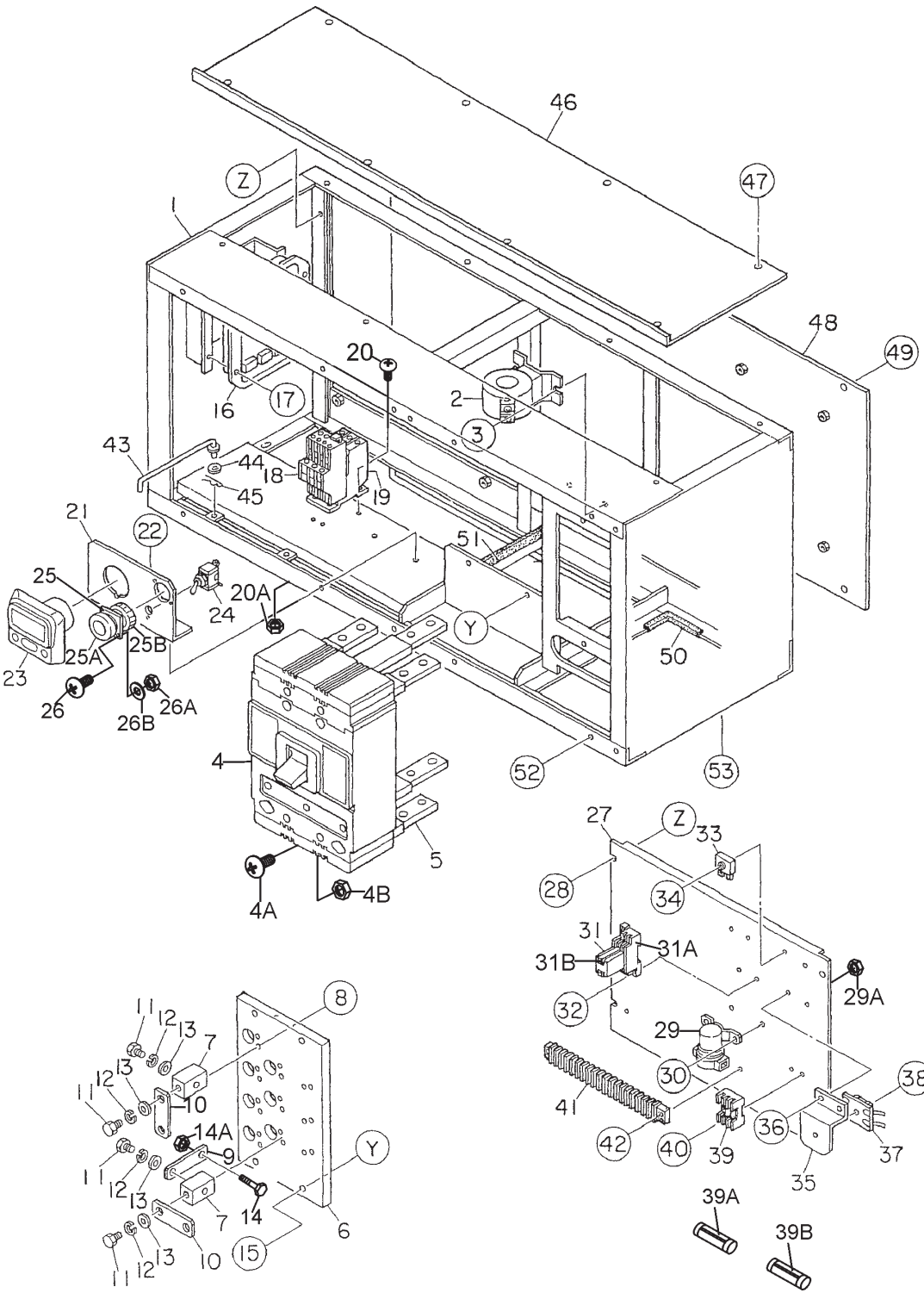

## CONTROL BOX ASSY.

### CONTROL BOX ASSY.

<u>NO.</u>	<u>PART NO.</u>	<u>PART NAME</u>	<u>QTY.</u>	<u>REMARKS</u>
1	M3213001302	CONTROL BOX	1	
2	0601809666	CURRENT TRANSFORMER, 300/5A	3	
3	0027106018	MACHINE SCREW	6	
4	0601870423	CIRCUIT BREAKER, 500A	1	
4A	0021006045	MAVHINE SCREW	4	
4B	0207006000	HEX. NUT	4	
5	0601815168	REAR CONNECTOR KIT	1	
6	M3273000003	TERMINAL BOARD, VOLTAGE CHANGE-OVER	1	
7	M3276400004	CHANGE TERMINAL	10	
8	0017106025	HEX. HEAD BOLT	20	
9	M4276200004	TERMINAL PLATE	3	
10	M3276300004	CHANGE-OVER PALTE	6	
11	M4276100004	TIE BOLT	20	
12	0040001000	LOCK WASHER	20	
13	0041410000	WASHER, FLAT	20	
14	0017110040	HEX. HEAD BOLT	3	
14A	0207010000	HEX. NUT	4	
15	0016908030	HEX. HEAD BOLT	4	
16	0601820625	AUTOMATIC VOLTAGE REGULATOR, 5A	1	
17	0027105016	MACHINE SCREW	4	
18	0601820847	OVER CURRENT RELAY	1	
19	0601820848	OVER CURRENT RELAY, 25A	1	
20	0027104016	MACHINE SCREW	2	
20A	0207004000	HEX. NUT	2	
21	M4260600304	BRACKET, DIAGNOSTIC GAUGE	1	
22	0016908020	HEX. HEAD BOLT	2	
23	0602120690	POWER VIEW	1	
24	0601831330	DIAGNOSTIC SWITCH	1	
25	0601813977	RECEPTACLE	1	
25A	0601812891	DUST CAP	1	
25B	0601812890	STRAIN RELIEF	1	
26	0027103015	MACHINE SCREW	2	
26A	0030003000	HEX. NUT	2	
26B	0041203000	DRAIN WASHER	2	

# CONTROL BOX ASSY.

CONTROL BOX ASSY.

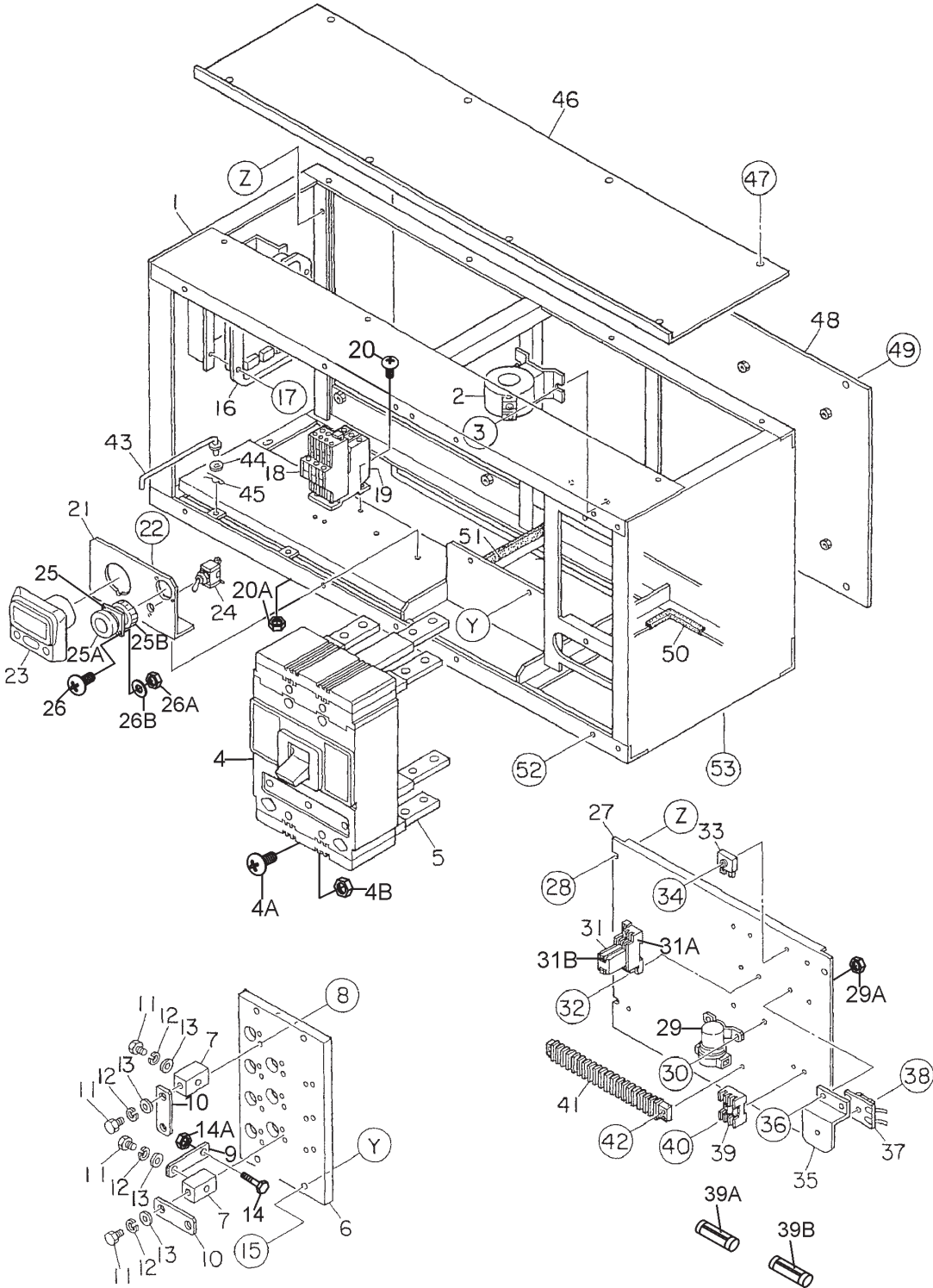



## CONTROL BOX ASSY.

### CONTROL BOX ASSY. ( CONT.)

<u>NO.</u>	<u>PART NO.</u>	<u>PART NAME</u>	<u>QTY.</u>	<u>REMARKS</u>
27	M4260500003	SET PANEL, ELECTRIC PARTS	1	
28	0016908020	HEX. HEAD BOLT	4	
29	0602202592	STARTER RELAY	1	
29A	0030006000	HEX. NUT	2	
30	0027106016	MACHINE SCREW	2	
31	LY2DUS12VDC	RELAY .....	1.....	REPLACES P/N 0601827656
31A	PTF08A	BASE .....	1.....	REPLACES P/N 0601823109
31B	PYCA1	CLIP .....	2.....	REPLACES P/N 0601824400
32	0027104020	MACHINE SCREW	2	
33	0601823240	RECTIFIER	2	
34	0027104020	MACHINE SCREW	2	
35	M4260600404	BRACKET, RESISTOR UNIT	1	
36	0016906016	HEX. HEAD BOLT	2	
37	M4266600004	RESISTOR UNIT	1	
38	0027105016	MACHINE SCREW	1	
39	0601802218	HOLDER, FUSE 3P	1	
39A	0601806653	FUSE, RIGHT SIDE 20A	1	
39B	0601802149	FUSE, CENTER 10A	1	
40	0027103020	MACHINE SCREW	2	
41	0601815154	TERMINAL SCREW	2	
42	0027104016	MACHINE SCREW	2	
43	M4213600104	STOPPER, CONTROL PANEL	1	
44	0041206000	WASHER, FLAT	1	
45	0605010502	SNAP PIN	1	
46	M4213500104	COVER, CONTROL BOX	1	
47	0016908020	HEX. HEAD BOLT	8	
48	M4213400104	BACK PANEL, CONTROL BOX	1	
49	0016908020	HEX. HEAD BOLT	8	
50	0330000300	EDGING	1	
51	0330000215	EDGING	1	
52	0016908020	HEX. HEAD BOLT	8	
53	0016908020	HEX. HEAD BOLT	6	

# ENGINE AND RADIATOR ASSY.

## ENGINE AND RADIATOR ASSY.

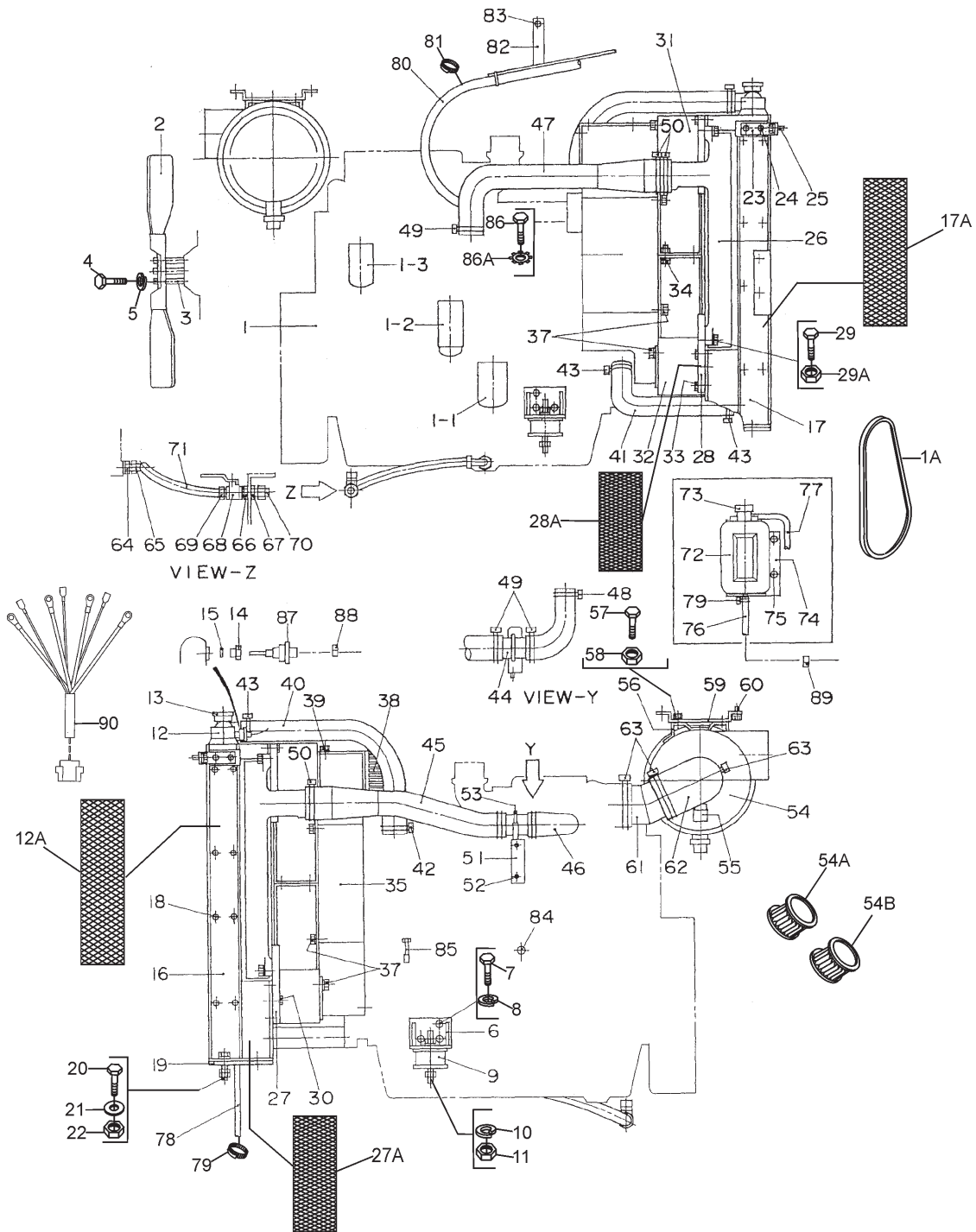

# ENGINE AND RADIATOR ASSY.

## ENGINE AND RADIATOR ASSY.

<u>NO.</u>	<u>PART NO.</u>	<u>PART NAME</u>	<u>QTY.</u>	<u>REMARKS</u>
1	M4923200034	ENGINE	1	
1A	0602015230	FAN BELT	1	
1-1	RE504836	CARTRIDGE, OIL FILTER .....	1	REPLACES P/N 0602041292
1-2	RE529643	CARTRIDGE, PRIMARY FUEL FILTER .....	1	REPLACES P/N 0602042596
1-3	RE522878	CARTRIDGE, FINAL FUEL FILTER .....	1	REPLACES P/N 0602042597
2	0602060015	BLOWER FAN	1	
3	R81876	FAN SPACER .....	1	REPLACES P/N 0602061003
4	0012110110	HEX HEAD BOLT	4	
5	0042510000	LOCK WASHER	4	
6	M3303200404	ENGINE FOOT	2	
7	0010312030	HEX. HEAD BOLT	6	
8	0040012000	LOCK WASHER	6	
9	0605000011	RUBBER SUSPENSION	2	
10	0030016000	HEX. NUT	4	
11	0040016000	LOCK WASHER	4	
12	M4923200014	RADIATOR	1	
12A	M4493601304	ACOUSTIC SHEET	2	
13	0602011062	CAP	1	
14	M9200101004	ADAPTOR	1	
15	0150000016	O-RING	1	
16	M4310201103	SUPPORTER, RADIATOR	1	
17	M4310201203	SUPPORTER, RADIATOR	1	
17A	M4493601504	ACOUSTIC SHEET	1	
18	0016918020	HEX. HEAD BOLT	15	
19	M4310600304	RUBBER SHEET	2	
20	0017112055	HEX. HEAD BOLT	4	
21	0030012000	HEX. NUT	8	
23	0041212000	WASHER, FLAT	4	
24	0016910025	HEX. HEAD BOLT	4	
25	0016910025	HEX. HEAD BOLT	2	
26	M4923200044	INTER COOLER	1	
27	M4310201304	BRACKET, INTER COOLER	1	
27A	M4493601604	ACOUSTIC SHEET	1	
28	M4310201404	BRACKET, INTER COOLER	1	
28A	M4493601604	ACOUSTIC SHEET	1	
29	0017110050	HEX. HEAD BOLT	4	
29A	0207010000	HEX. NUT	4	
30	0016908020	HEX. HEAD BOLT	4	
31	M4310301103	FAN SHROUD	1	
32	M4310301203	FAN SHROUD	1	
33	0016908020	HEX. HEAD BOLT	6	
34	0016908020	HEX. HEAD BOLT	4	
35	M4310300903	FAN GUARD	1	
36	M4310301003	FAN GUARD	1	
37	0016908020	HEX. HEAD BOLT	11	
38	M4310300803	FAN GUARD	1	
39	0016908020	HEX. HEAD BOLT	8	
40	M4310500803	RADIATOR HOSE	1	
41	M4310500903	RADIATOR HOSE	1	
42	0605515178	HOSE BAND	1	

# ENGINE AND RADIATOR ASSY. (CONT)

## ENGINE AND RADIATOR ASSY. (CONT.)

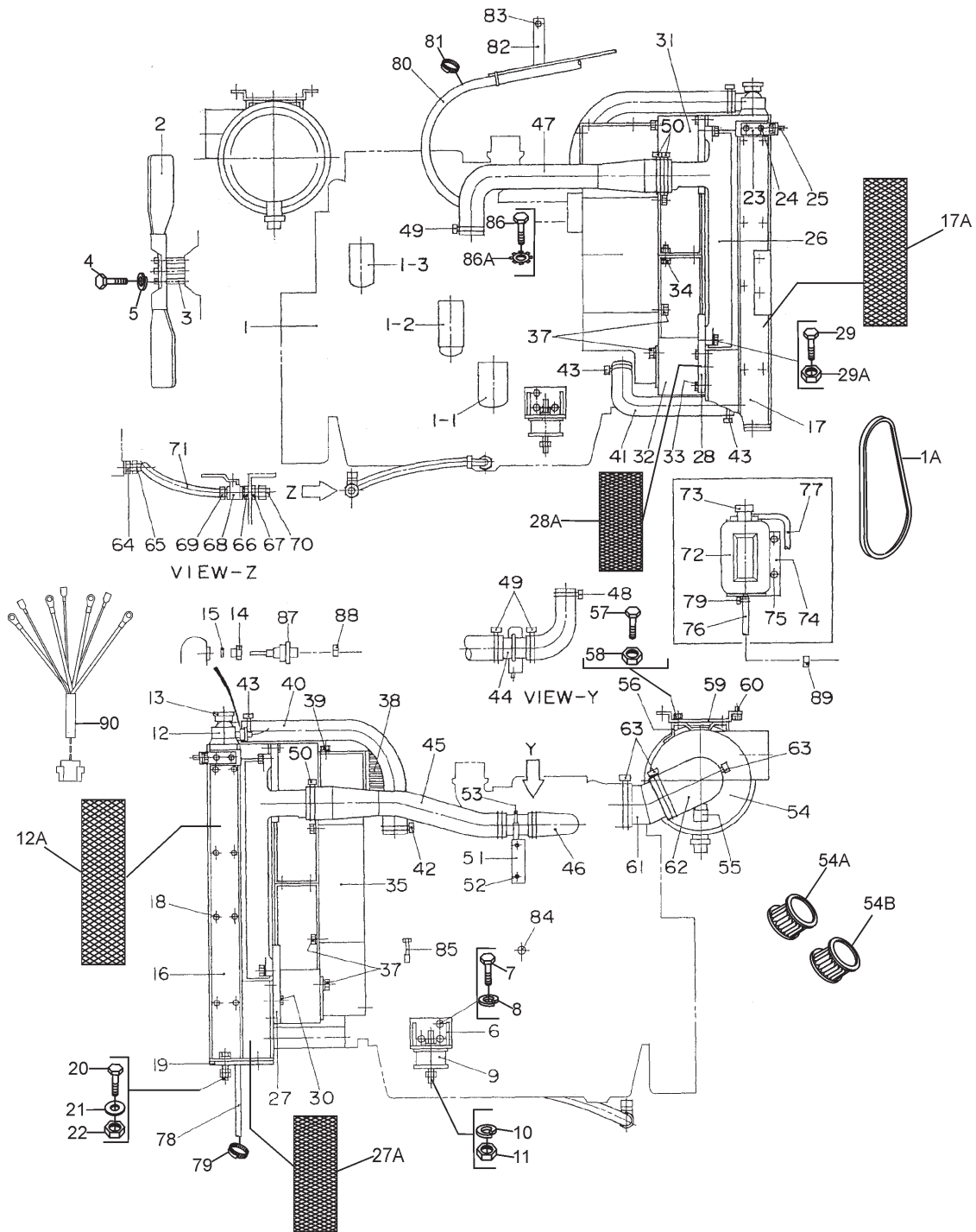

## ENGINE AND RADIATOR ASSY. (CONT)

### ENGINE AND RADIATOR ASSY. (CONT.)

<u>NO.</u>	<u>PART NO.</u>	<u>PART NAME</u>	<u>QTY.</u>	<u>REMARKS</u>
43	0605515199	HOSE BAND	3	
44	M4310401004	INTER COOLER PIPE	1	
45	M4310501303	INTER COOLER HOSE	1	
46	M4310501003	INTER COOLER HOSE	1	
47	M4310501403	INTER COOLER HOSE	1	
48	0605515207	HOSE BAND	1	
49	0605515208	HOSE BAND	3	
50	0605515209	HOSE BAND	3	
51	M4310600404	BRACKET, INTER COOLER PIPE	1	
52	0016908020	HEX. HEAD BOLT	2	
53	0602326063	U-BOLT	1	
54	0602046586	AIR CLEANER	1	
54A	0602046682	ELEMENT, AIR CLEANER OUTER	1	
54B	0602046683	ELEMENT, AIR CLEANER INNER	1	
55	0602040650	INDICATOR, AIR CLEANER	1	
56	0602040558	BAND, AIR CLEANER	2	
57	0016908020	HEX. HEAD BOLT	4	
58	0207008000	HEX. NUT	4	
59	M4373200304	BRACKET, AIR CLEANER	1	
60	0016908020	HEX. HEAD BOLT	4	
61	M4373000104	AIR CLEANER PIPE	1	
62	0602040365	90° ELBOW	1	
63	0605515202	HOSE BAND	3	
64	0602022580	ADAPTER	1	
65	0602022561	90° ELBOW	1	
66	0603306590	CONNECTOR	1	
67	0603300285	ROCKNUT	1	
68	0605511395	VALVE	1	
69	0603306395	HOSE JOINT	1	
70	0602021070	CAP	1	
71	0269200660	DRAIN HOSE	1	
72	M9300000203	RESERVE TANK	1	
73	0602010900	CAP, RESERVE TANK	1	
74	M4316100103	BRACKET, RESERVE TANK	1	
75	0016910025	HEX HEAD BOLT	2	
76	0199901850	HOSE	1	
77	0193601250	HOSE	1	
78	0193600700	HOSE	1	
79	0605515106	HOSE BAND	3	
80	0191601700	BLOWBY HOSE	1	
81	0605515149	HOSE BAND	2	
82	M448360003	HOSE GUIDE	1	
83	0016908020	HOSE GUIDE	1	
84	0602017090	DRAIN VALVE	1	
85	0602042601	LEAK OFF LINE	1	
86	0017110020	HEX HEAD BOLT	1	
87	0602123290	COOLANT LEVEL SWITCH	1	
88	0602220910	CLAMP	1	
89	0602220911	CLAMP	1	

# OUTPUT TERMINAL ASSY.

OUTPUT TERMINAL ASSY.

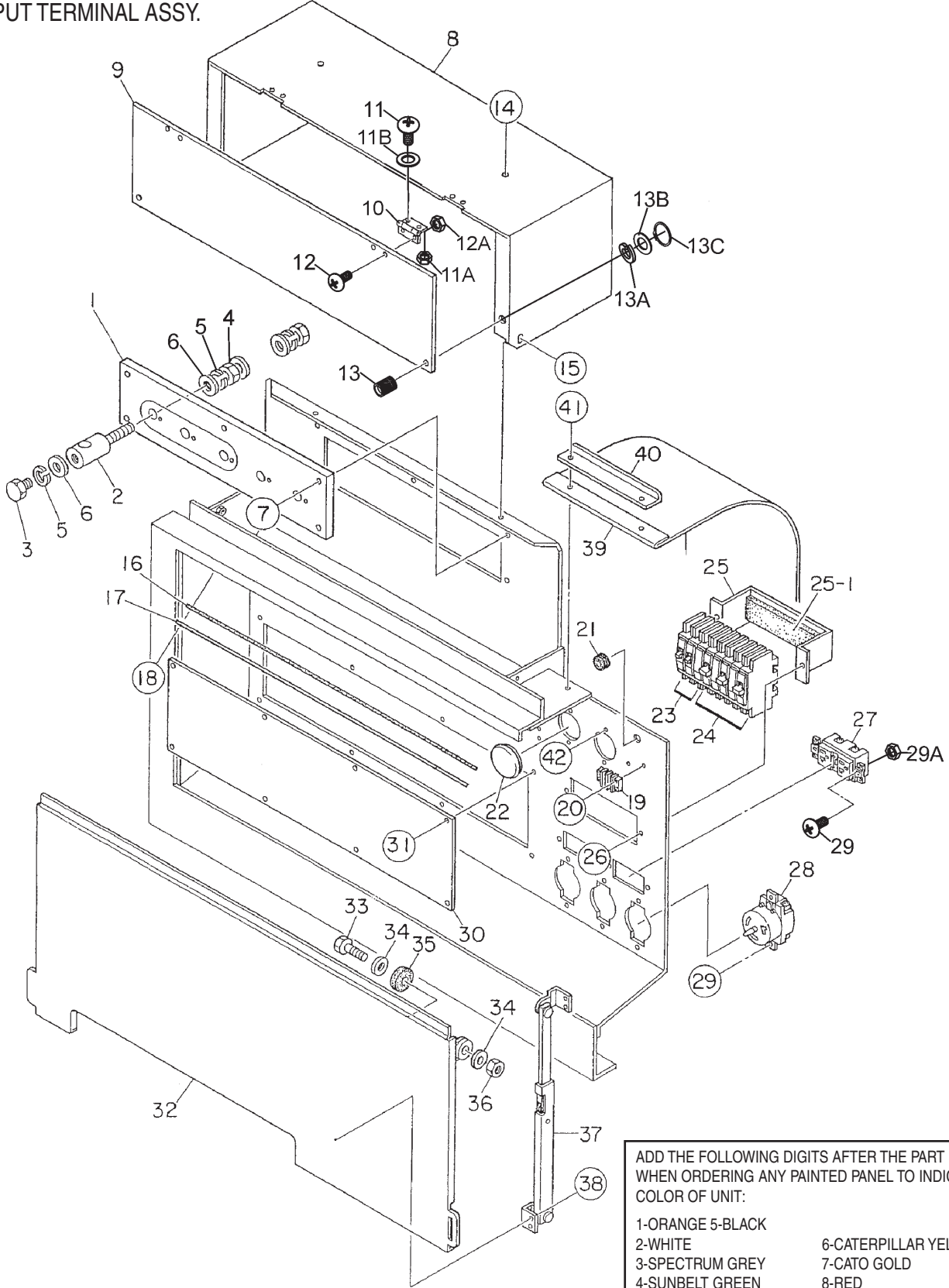

ADD THE FOLLOWING DIGITS AFTER THE PART NUMBER WHEN ORDERING ANY PAINTED PANEL TO INDICATE COLOR OF UNIT:

1-ORANGE	5-BLACK	6-CATERPILLAR YELLOW
2-WHITE		7-CATO GOLD
3-SPECTRUM GREY		8-RED
4-SUNBELT GREEN		

THE SERIAL NUMBER MAY BE REQUIRED.

## OUTPUT TERMINAL ASSY.

### OUTPUT TERMINAL ASSY.

<u>NO.</u>	<u>PART NO.</u>	<u>PART NAME</u>	<u>QTY.</u>	<u>REMARKS</u>
1	M3230700113	TERMINAL BOARD	1	
2	M9220100914	OUTPUT TERMINAL BOLT	5	
3	M9220101004	TIE BOLT	5	
4	0039320000	HEX. NUT	10	
5	0040020000	LOCK WASHER	15	
6	0041420000	WASHER, FLAT	20	
7	0016908040	HEX. HEAD BOLT	5	
8	M4236100403	TERMINAL COVER	1	
9	M4236100504	OUTPUT WINDOW	1	
10	0605010040	HINGE	2	
11	0027103010	MACHINE SCREW	4	
11A	0030003000	HEX. NUT	4	
11B	0041203000	WASHER, FLAT	4	
12	0027103015	MACHINE SCREW	4	
12A	0030003000	HEX. NUT	4	
13	M9220100804	SET SCREW	2	
13A	0040006000	LOCK WASHER	2	
13B	0041206000	WASHER, FLAT	2	
13C	0080200005	RETAINING RING	2	
14	0019206015	HEX. HEAD BOLT	2	
15	0019206015	HEX. HEAD BOLT	2	
16	M4236400004	CABLE, OUTLET COVER	1	
17	M4236400104	SUPPORTER, CABLE OUTLET COVER	1	
18	0019206015	HEX. HEAD BOLT	8	
19	0601815194	TERMINAL BLOCK	1	
20	0025304015	MACHINE SCREW	2	
21	0601850275	GROMMET	1	
22	0603306775	GROMMET	2	
23	0601808803	CIRCUIT BREAKER, 20A	2	
24	0601808804	CIRCUIT BREAKER, 50A	3	



# OUTPUT TERMINAL ASSY.

## OUTPUT TERMINAL ASSY.

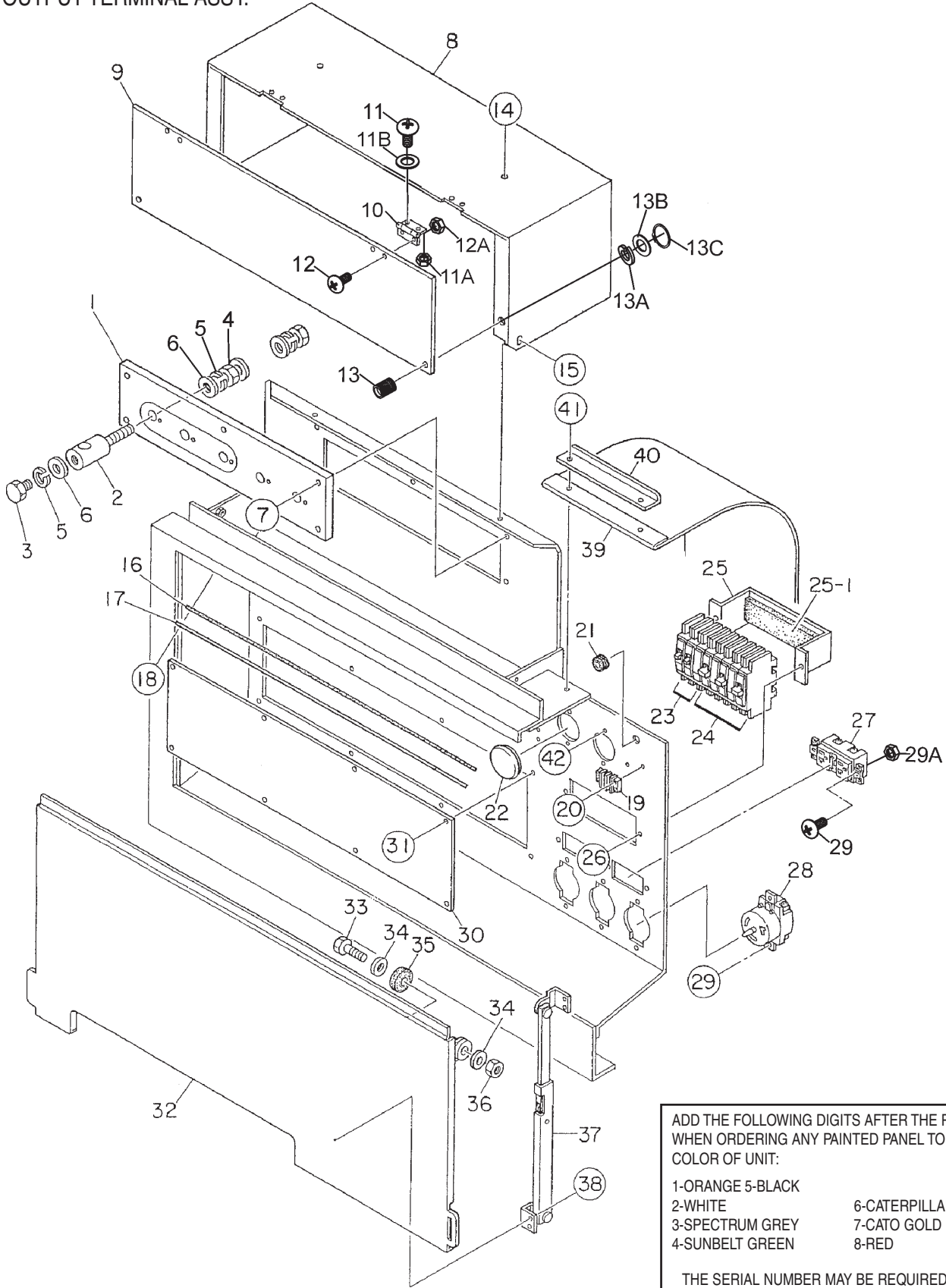

ADD THE FOLLOWING DIGITS AFTER THE PART NUMBER WHEN ORDERING ANY PAINTED PANEL TO INDICATE COLOR OF UNIT:

1-ORANGE	5-BLACK	6-CATERPILLAR YELLOW
2-WHITE		7-CATO GOLD
3-SPECTRUM GREY		8-RED
4-SUNBELT GREEN		

THE SERIAL NUMBER MAY BE REQUIRED.

## OUTPUT TERMINAL ASSY.

---

### OUTPUT TERMINAL ASSY. (CONT.)

<u>NO.</u>	<u>PART NO.</u>	<u>PART NAME</u>	<u>QTY.</u>	<u>REMARKS</u>
25	M4260600104	BRACKET, CIRCUIT BREAKER	1	
25-1	022100150	RUBBER CUSHION	1	
26	0019206020	HEX. HEAD BOLT	2	
27	0601812538	RECEPTACLE, 20A	2	
28	0601812538	RECEPTACLE, 50A	3	
29	0025304015	MACHINE SCREW	10	
29A	0207004000	HEX. NUT	10	
30	M4236400204	COVER	1	
31	0019206015	HEX. HEAD BOLT	8	
32	M4236100303	TERMINAL COVER	1	
33	0010112045	HEX. HEAD BOLT	2	
34	0041212000	FLAT WASSHER	4	
35	M9310200004	STAY RUBBER	2	
36	0030012000	HEX. NUT	2	
37	0605011505	STAY	1	
38	0025305015	HEX. HEAD BOLT	4	
39	M4236100604	COVER	1	
40	M4236400304	BRACKET	1	
41	0019206015	HEX. HEAD BOLT	2	
42	0025304015	MACHINE SCREW	4	

# BATTERY ASSY.

BATTERY ASSY.

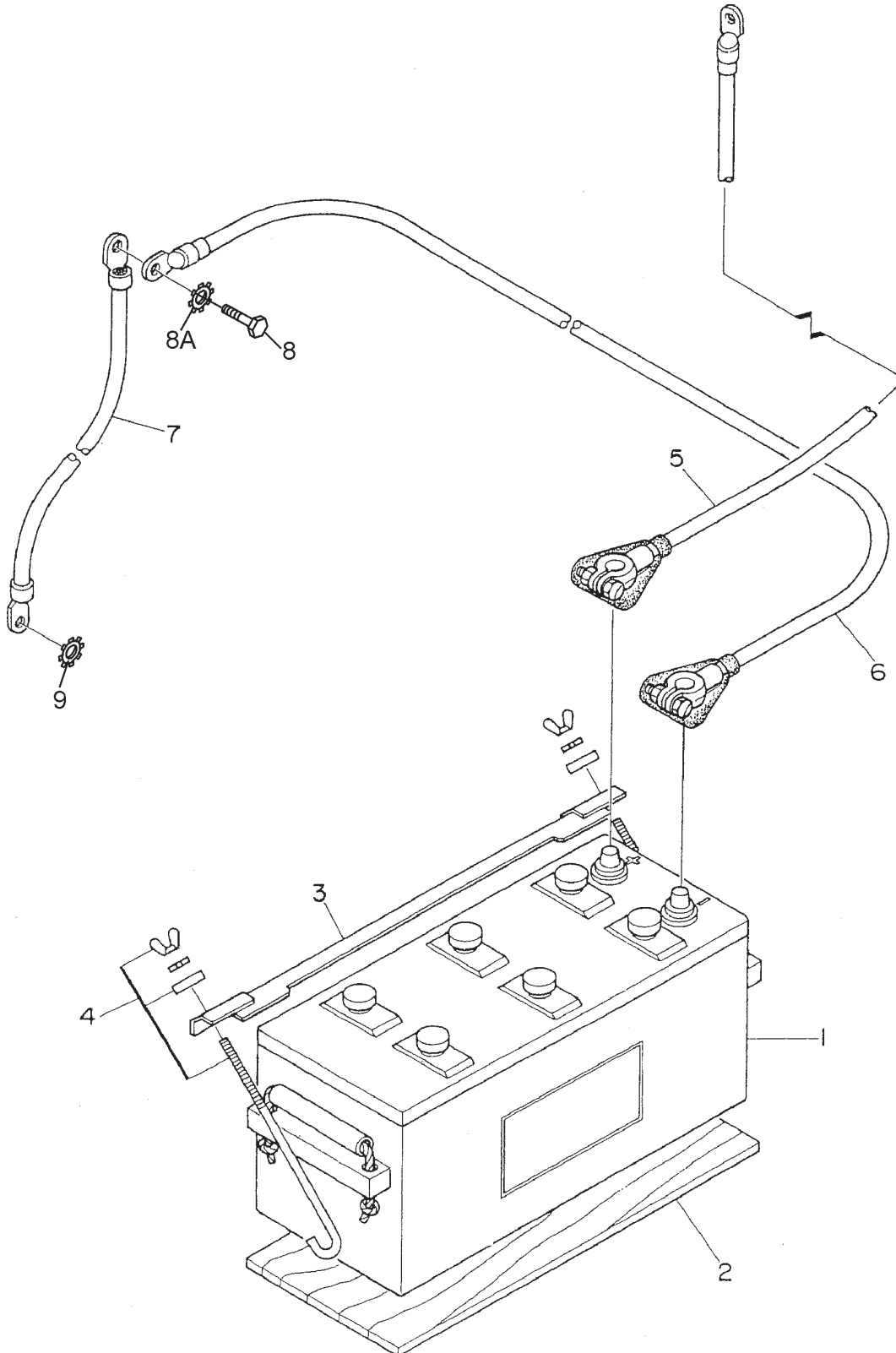

# BATTERY ASSY.

---

## BATTERY ASSY.

<u>NO.</u>	<u>PART NO.</u>	<u>PART NAME</u>	<u>QTY.</u>	<u>REMARKS</u>
1	0602220196	BATTERY	1	
2	M9310500404	BATTERY SHEET	1	
3	M9103000504	BATTERY SHEET	1	
4	0602220921	BATTERY BOLT SET	2	
5	M4346900304	BATTERY CABLE	1	
6	M4346900204	BATTERY CABLE	1	
7		CABLE .....	1	MAKE LOCALLY
8	0017116030	HEX. HEAD BOLT	1	
8A	0040516000	TOOTHED WASHER	1	
9	0040520000	TOOTHED WASHER	1	

# MUFFLER ASSY.

MUFFLER ASSY.

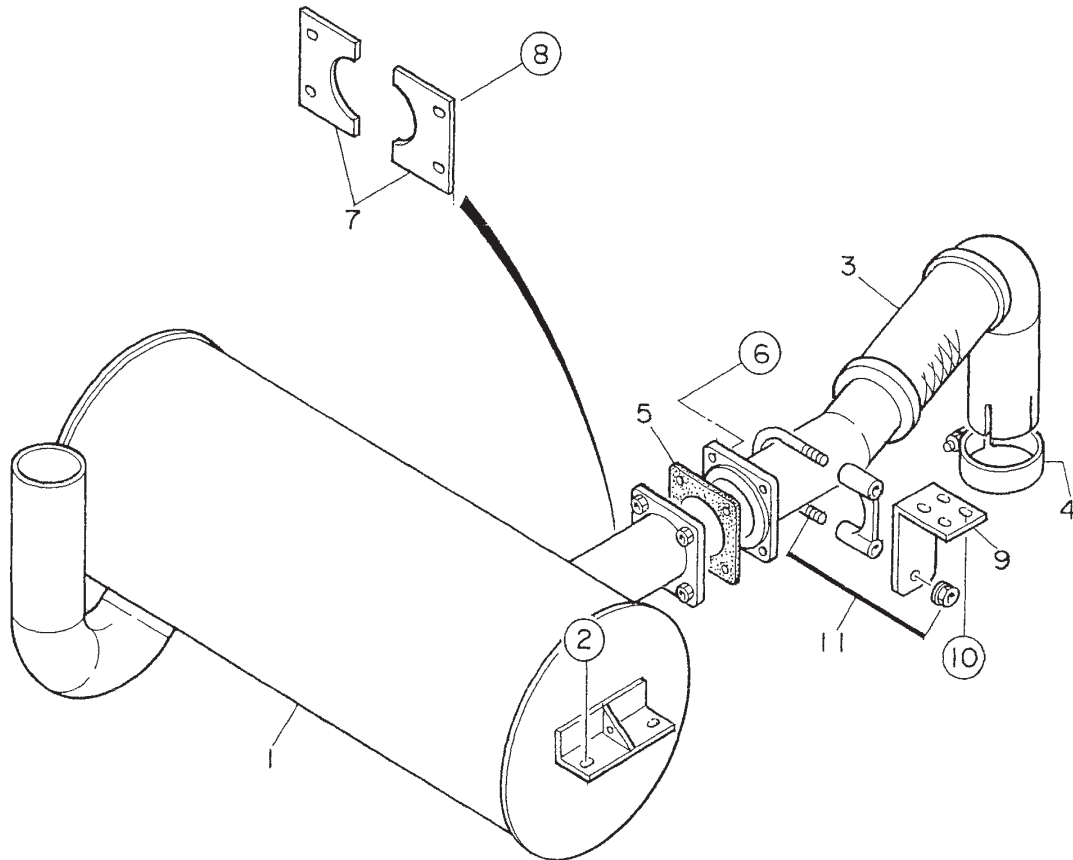

## MUFFLER ASSY.

---

### MUFFLER ASSY.

<u>NO.</u>	<u>PART NO.</u>	<u>PART NAME</u>	<u>QTY.</u>	<u>REMARKS</u>
1	M4330100502	MUFFLER	1	
2	0016910025	HEX. HEAD BOLT	4	
3	M4333000303	EXHAUST PIPE	1	
4	0602325066	CLAMP	1	
5	M4333200004	GASKET	1	
6	0017112055	HEX. HEAD BOLT	4	
7	M4330300004	COVER	2	
8	0016908020	HEX. HEAD BOLT	4	
9	M4333300304	BRACKET	1	
10	0016908020	HEX. HEAD BOLT	4	
11	0602326062	U BOLT SET	1	

# FUEL TANK ASSY.

FUEL TANK ASSY.

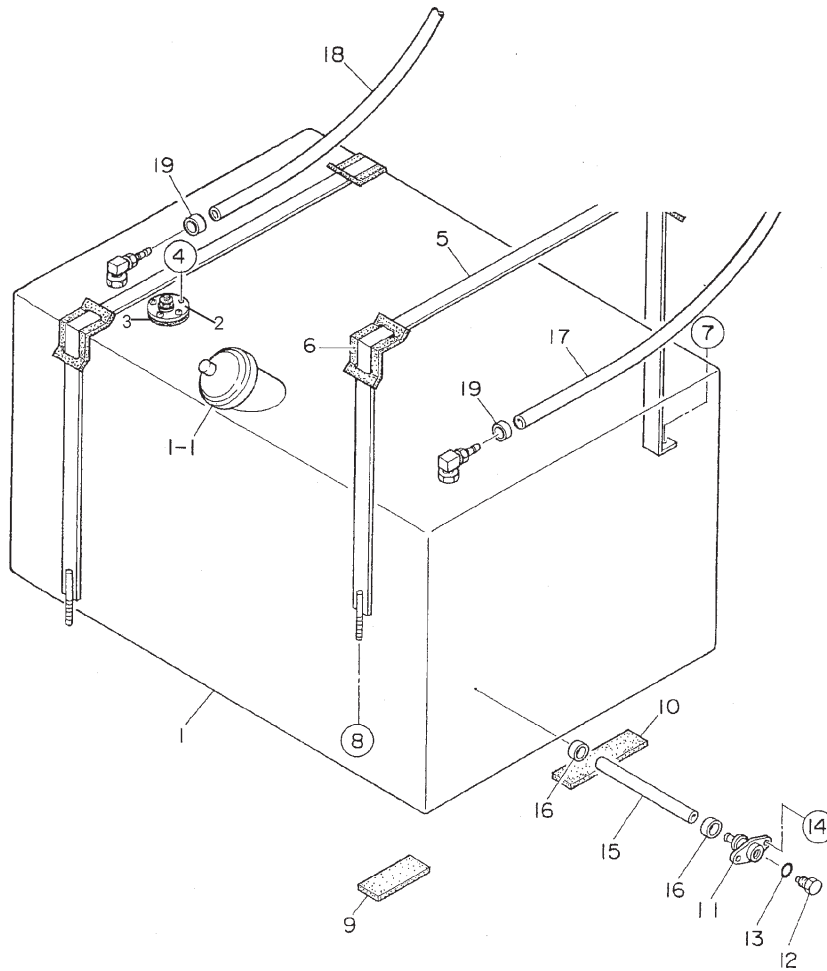



## FUEL TANK ASSY.

### FUEL TANK ASSY.

<u>NO.</u>	<u>PART NO.</u>	<u>PART NAME</u>	<u>QTY.</u>	<u>REMARKS</u>
1	M4363000102	FUEL TANK	1	
1-1	0605505070	CAP. FUEL TANK	1	
2	0605501069	FUEL SENDER UNIT	1	
3	0605516090	GASKET	1	
4	0027104016	MACHINE SCREW	5	
5	M4363200104	TANK BAND	2	
6	M9310500104	SUPPORTER SHEET	4	
7	0016908020	HEX. HEAD BOLT	2	
8	0207308000	SUPER LOCK NUT	2	
9	0222100120	RUBBER SHEET	2	
10	0222100180	RUBBER SHEET	2	
11	M9200000003	DRAIN JOINT	1	
12	M9200200004	DRAIN BOLT	1	
13	0150000018	O RING	1	
14	0016906020	HEX. HEAD BOLT	2	
15	M1363400104	DRAIN HOSE	2	
16	0605515198	HOSE BAND	1	
17	0191302800	SUCTION HOSE	1	
18	0191302200	RETURN HOSE	1	
19	0605515109	HOSE BAND	4	

# ENCLOSURE ASSY.

## ENCLOSURE ASSY.

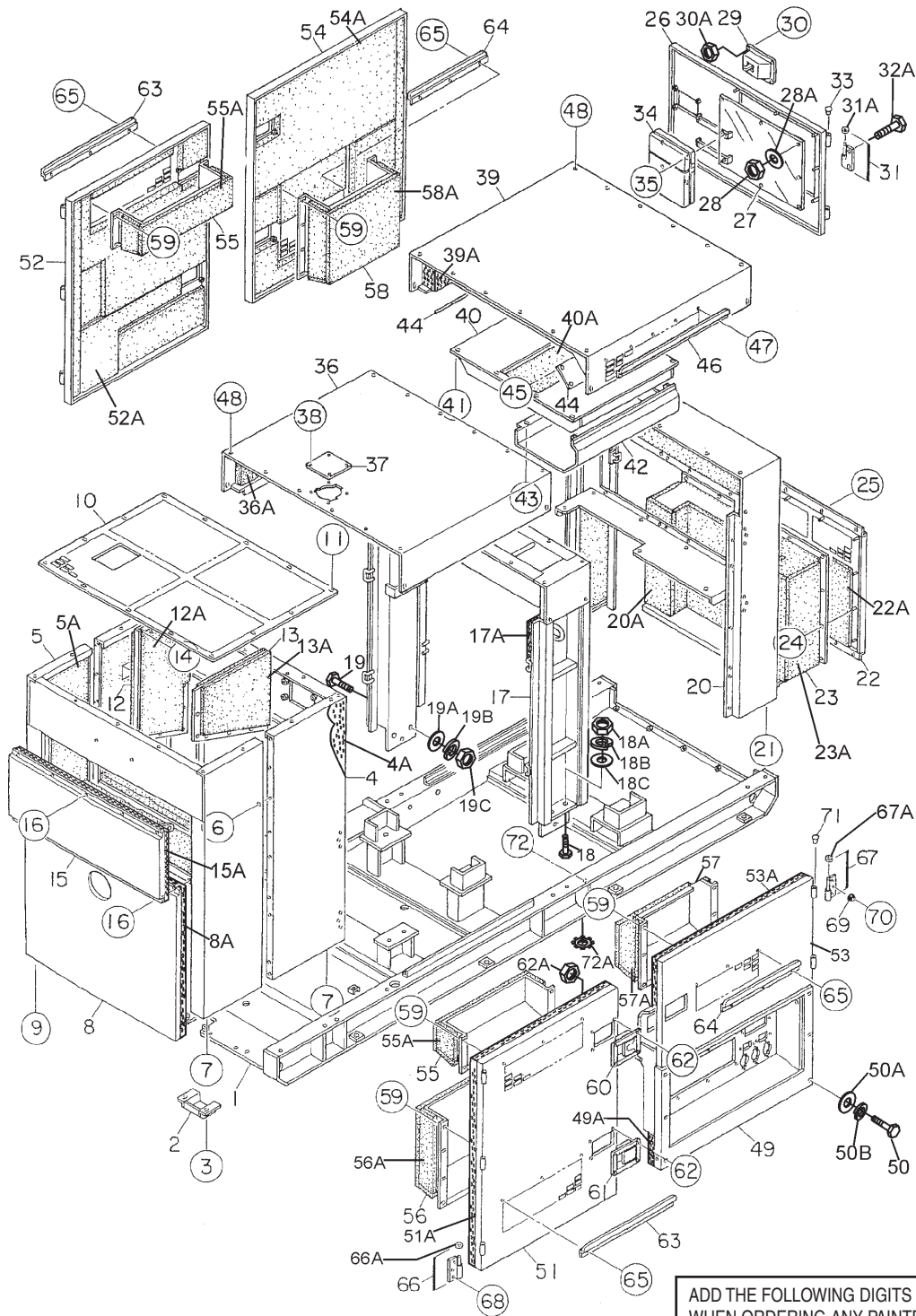

ADD THE FOLLOWING DIGITS AFTER THE PART NUMBER WHEN ORDERING ANY PAINTED PANEL TO INDICATE COLOR OF UNIT:

- |                 |         |                      |
|-----------------|---------|----------------------|
| 1-ORANGE        | 5-BLACK |                      |
| 2-WHITE         |         | 6-CATERPILLAR YELLOW |
| 3-SPECTRUM GREY |         | 7-CATO GOLD          |
| 4-SUNBELT GREEN |         | 8-RED                |

THE SERIAL NUMBER MAY BE REQUIRED.

## ENCLOSURE ASSY.

### ENCLOSURE ASSY.

<u>NO.</u>	<u>PART NO.</u>	<u>PART NAME</u>	<u>QTY.</u>	<u>REMARKS</u>
1	M4413000302	BASE	1	
2	M1413400004	COVER	1	
3	0019208020	HEX. HEAD BOLT	2	
4	M4423000312	FRONT FRAME	1	
4A	M4493102513	ACOUSTIC SHEET	1	
5	M4423000412	FRONT FRAME	1	
5A	M4493102513	ACOUSTIC SHEET	1	
6	0016908020	HEX. HEAD BOLT	13	
7	0019210030	HEX. HEAD BOLT	8	
8	M4493102704	ACOUSTIC SHEET	1	
9	0019208020	HEX. HEAD BOLT	6	
10	M4423200403	OVER COVER, FRONT FRAME	1	
11	0019208020	HEX. HEAD BOLT	14	
12	M4423300014	DISCHARGE GUIDE	1	
12A	M4493601414	ACOUSTIC SHEET	1	
13	M4423300114	DISCHARGE GUIDE	1	
13A	M4493601414	ACOUSTIC SHEET	1	
14	0019206020	HEX. HEAD BOLT	12	
15	M4423200204	COVER, FRONT FRAME	1	
15A	M4493102604	ACOUSTIC SHEET	1	
16	0019208020	HEX. HEAD BOLT	10	
17	M4433000102	CENTER FRAME	1	
17A	M4493200104	ACOUSTIC SHEET	1	
18	0010114050	HEX. HEAD BOLT	4	
18A	0030014000	HEX. NUT	4	
18B	0040014000	LOCK WASHER	4	
18C	0041214000	WASHER, FLAT	8	
19	0010120045	HEX. HEAD BOLT	4	
19A	0030020000	HEX. NUT	4	
19B	0040020000	LOCK WASHER	4	
19C	0041220000	WASHER, FLAT	8	
20	M4443000102	REAR FRAME	1	
20A	M4493301904	ACOUSTIC SHEET	1	
21	0019210030	HEX. HEAD BOLT	4	
22	M4443300204	COVER, REAR FRAME	1	
22A	M4443302004	ACOUSTIC SHEET	1	
23	M4443300303	DUCT	1	
23A	M4493302104	ACOUSTIC SHEET	1	
24	0207008000	HEX. NUT	11	
25	0019208020	HEX. HEAD BOLT	10	
26	M4443200403	DOOR, REAR FRAME	1	
27	M4443600004	WINDOW PLATE	1	

# ENCLOSURE ASSY. (CONT.)

## ENCLOSURE ASSY. (CONT.)

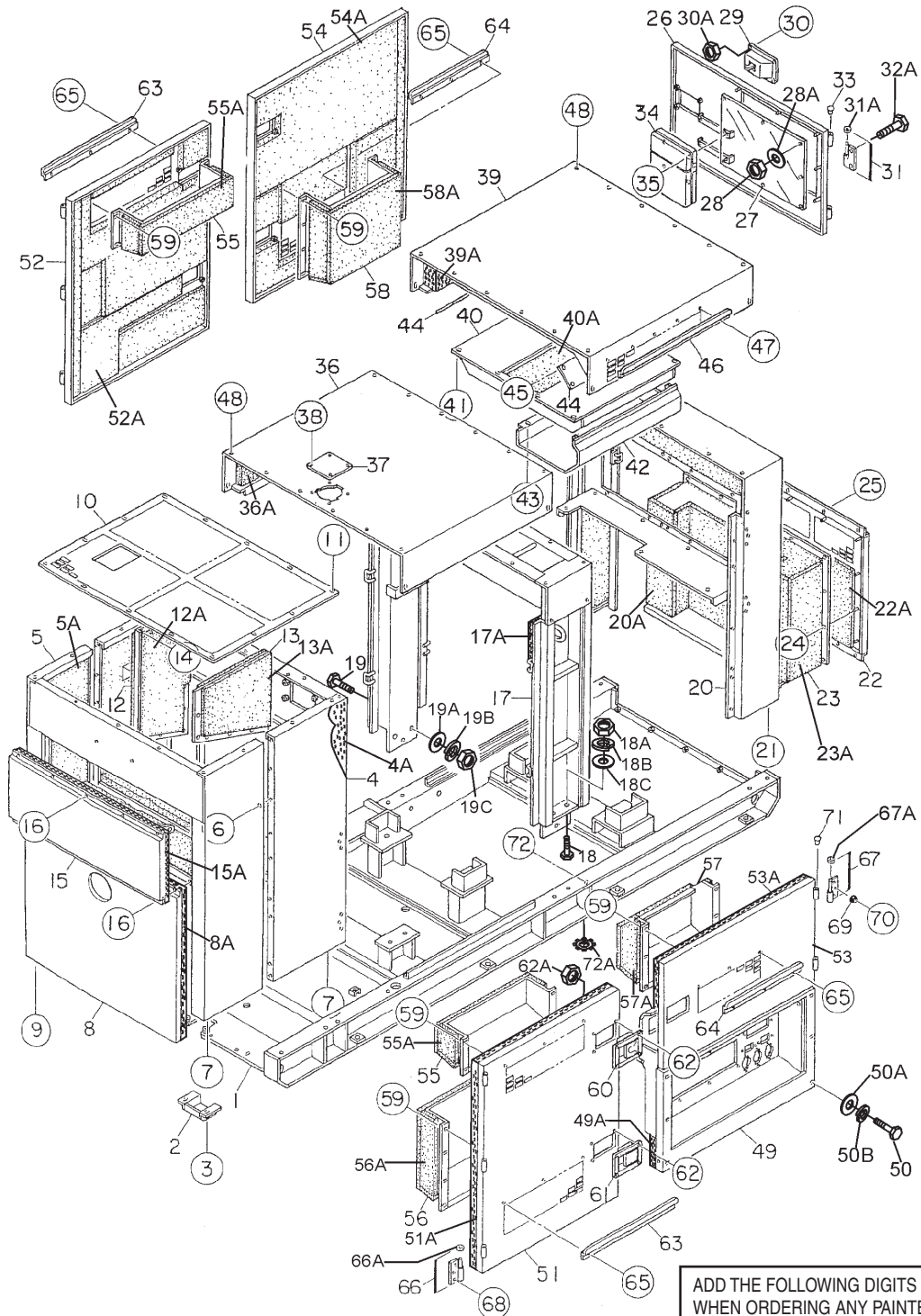

ADD THE FOLLOWING DIGITS AFTER THE PART NUMBER WHEN ORDERING ANY PAINTED PANEL TO INDICATE COLOR OF UNIT:

- |                 |         |                      |
|-----------------|---------|----------------------|
| 1-ORANGE        | 5-BLACK | 6-CATERPILLAR YELLOW |
| 2-WHITE         |         | 7-CATO GOLD          |
| 3-SPECTRUM GREY |         | 8-RED                |
| 4-SUNBELT GREEN |         |                      |

THE SERIAL NUMBER MAY BE REQUIRED.

## ENCLOSURE ASSY. (CONT.)

### ENCLOSURE ASSY. (CONT.)

<u>NO.</u>	<u>PART NO.</u>	<u>PART NAME</u>	<u>QTY.</u>	<u>REMARKS</u>
28	0037906000	SELF-LOCKING U NUT	8	
28A	0041206000	WASHER, FLAT	8	
29	M9113000002	DOOR HANDLE	1	
30	0021806016	MACHINE SCREW	4	
30A	0030006000	HEX. NUT	4	
31	M9110100204	HINGE	2	
31A	M9116100004	WASHER	2	
32	0019208020	HEX. HEAD BOLT	3	
33	M9310000004	BLIND PLUG	2	
34	0600800320	MANUAL PAK	1	
35	0021806016	MACHINE SCREW	4	
36	M4463100202	ROOF PANEL	1	
36A	M4493501003	ACOUSTIC SHEET	1	
37	M3310600004	COVER	1	
38	0019208020	HEX. HEAD BOLT	4	
39	M4463200202	ROOF PANEL	1	
39A	M4493501903	ACOUSTIC SHEET	1	
40	M4463200403	DUCT, REAR ROOF	1	
40A	M4493502004	ACOUSTIC SHEET	1	
41	0016908020	HEX. HEAD BOLT	10	
42	M4463400003	DUCT COVER	1	
43	0016908020	HEX. HEAD BOLT	7	
44	M4463200304	COVER	2	
45	0016906020	HEX. HEAD BOLT	12	
46	M4463500204	GUTTER	2	
47	0019206016	HEX. HEAD BOLT	8	
48	0019208020	HEX. HEAD BOLT	32	
49	M3453201302	SPLASHER PANEL	1	
49A	M4493403604	ACOUSTIC SHEET	1	
50	0019108065	HEX. HEAD BOLT	6	
50A	0042308000	LOCK WASHER	6	
50B	0042408000	WASHER, FLAT	6	

# ENCLOSURE ASSY. (CONT.)

## ENCLOSURE ASSY. (CONT.)

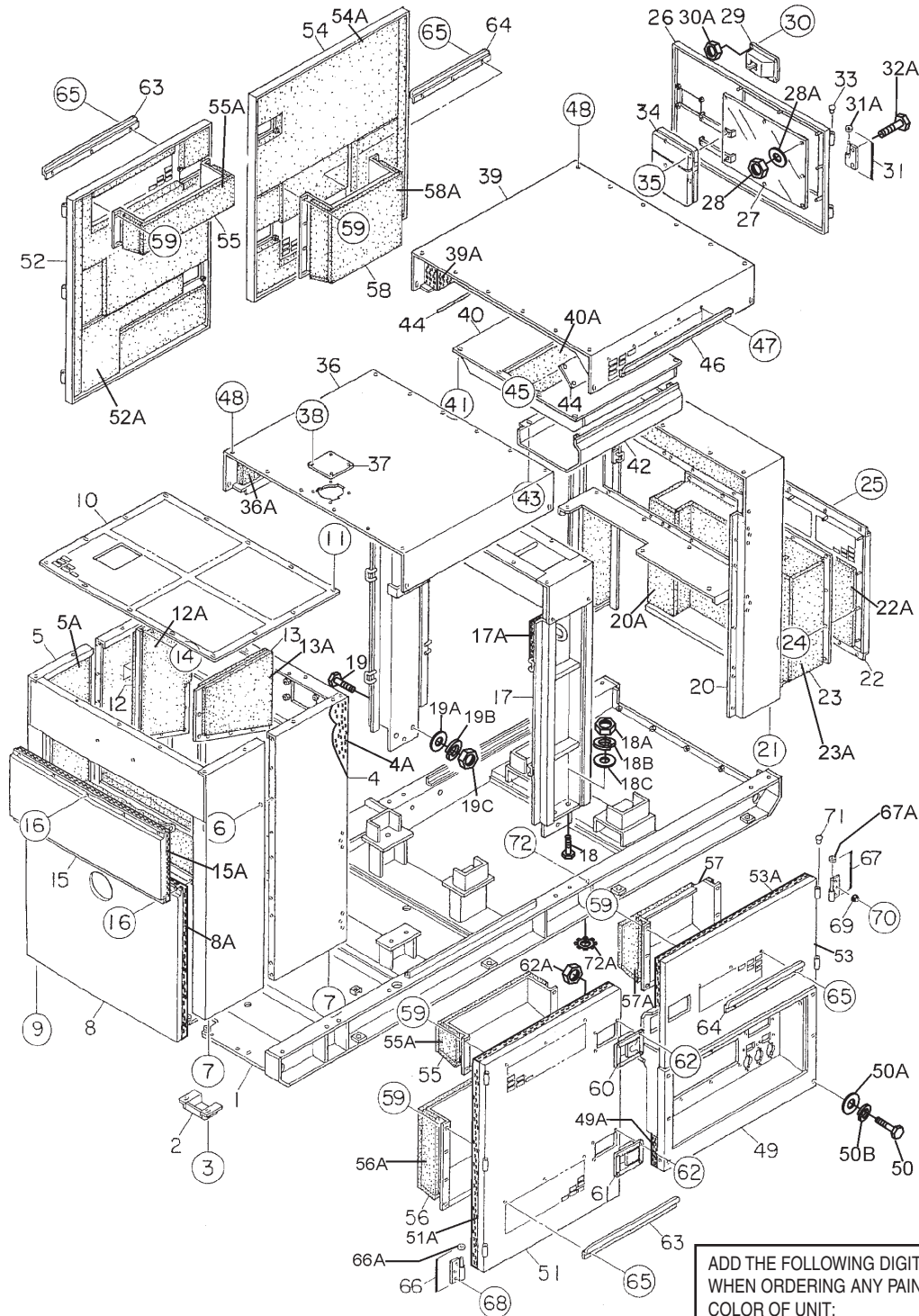

ADD THE FOLLOWING DIGITS AFTER THE PART NUMBER WHEN ORDERING ANY PAINTED PANEL TO INDICATE COLOR OF UNIT:

- |                 |         |                      |
|-----------------|---------|----------------------|
| 1-ORANGE        | 5-BLACK |                      |
| 2-WHITE         |         | 6-CATERPILLAR YELLOW |
| 3-SPECTRUM GREY |         | 7-CATO GOLD          |
| 4-SUNBELT GREEN |         | 8-RED                |

THE SERIAL NUMBER MAY BE REQUIRED.



## ENCLOSURE ASSY. (CONT.)

### ENCLOSURE ASSY. (CONT.)

<u>NO.</u>	<u>PART NO.</u>	<u>PART NAME</u>	<u>QTY.</u>	<u>REMARKS</u>
51	M4453001203	SIDE DOOR	1	
51A	M4493403804	ACOUSTIC SHEET	1	
52	M4453001303	SIDE DOOR	1	
52A	M4493403904	ACOUSTIC SHEET	1	
53	M4453001003	SIDE DOOR	1	
53A	M4493403004	ACOUSTIC SHEET	1	
54	M4453001103	SIDE DOOR	1	
54A	M4493403104	ACOUSTIC SHEET	1	
55	M4453301004	DUCT	2	
55A	M4493404004	ACOUSTIC SHEET	2	
56	M4453300504	DUCT	1	
56A	M4493403204	ACOUSTIC SHEET	1	
57	M4453300704	DUCT	1	
57A	M4493403404	ACOUSTIC SHEET	1	
58	M4453300804	DUCT	1	
58A	M4493403504	ACOUSTIC SHEET	1	
59	0207008000	HEX. NUT	3	
60	M9113000002	DOOR HANDLE	4	
61	M9113000102	DOOR HANDLE	3	
62	0021806016	MACHINE SCREW	28	
62A	0030006000	HEX. NUT	28	
63	M4453600004	GUTTER	3	
64	M4453600104	GUTTER	3	
65	0019206016	HEX. HEAD BOLT	15	
66	M9110100804	HINGE	6	
66A	M9116100004	WASHER	6	
67	M9110100904	HINGE	5	
67A	M9116100004	WASHER	5	
68	0019208020	HEX. HEAD NUT	25	
69	0601850097	STOPPER	9	
70	0025408025	MACHINE SCREW	9	
71	M9310000004	BLIND PLUG	11	
72	0016908020	HEX. HEAD BOLT	1	
72A	0040508000	TOOTHED WASHER	1	



# RUBBER SEALS ASSY.

RUBBER SEALS ASSY.

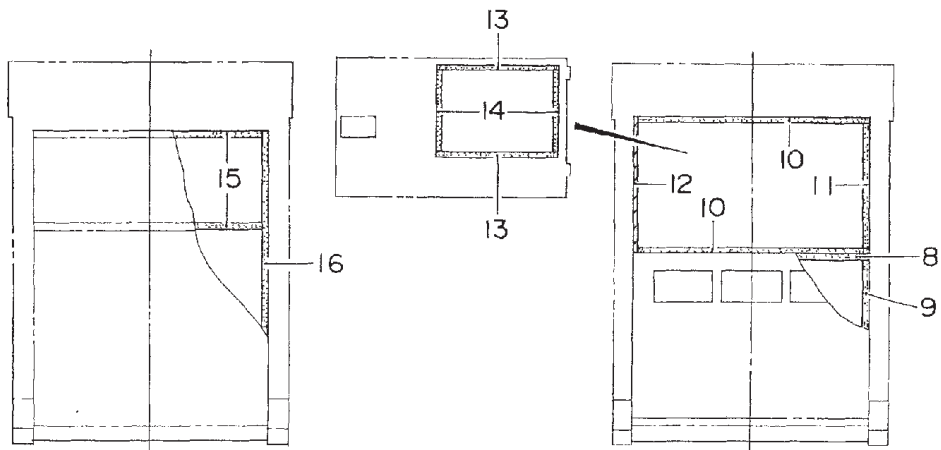
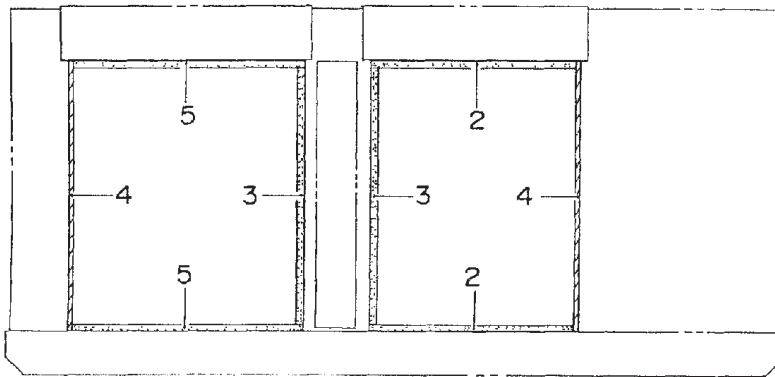
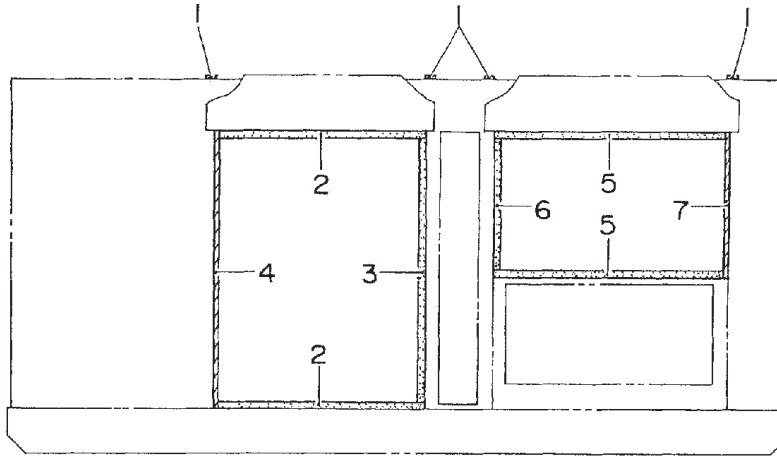

## RUBBER SEALS ASSY.

---

### RUBBER SEAL ASSY.

<u>NO.</u>	<u>PART NO.</u>	<u>PART NAME</u>	<u>QTY.</u>	<u>REMARKS</u>
1	0229201240	RUBBER SEAL	4	
2	0228900945	RUBBER SEAL	4	
3	0228901200	RUBBER SEAL	3	
4	0228901260	RUBBER SEAL	3	
5	0228901055	RUBBER SEAL	4	
6	0228900600	RUBBER SEAL	1	
7	0228900660	RUBBER SEAL	1	
8	0229201060	RUBBER SEAL	1	
9	0229200660	RUBBER SEAL	2	
10	0228801050	RUBBER SEAL	2	
11	0228800595	RUBBER SEAL	1	
12	0228800635	RUBBER SEAL	1	
13	0228100560	RUBBER SEAL	2	
14	0228100370	RUBBER SEAL	2	
15	0229201020	RUBBER SEAL	2	
16	0229201200	RUBBER SEAL	2	

# NAMEPLATE AND DECALS ASSY.

NAMEPLATE AND DECALS ASSY.

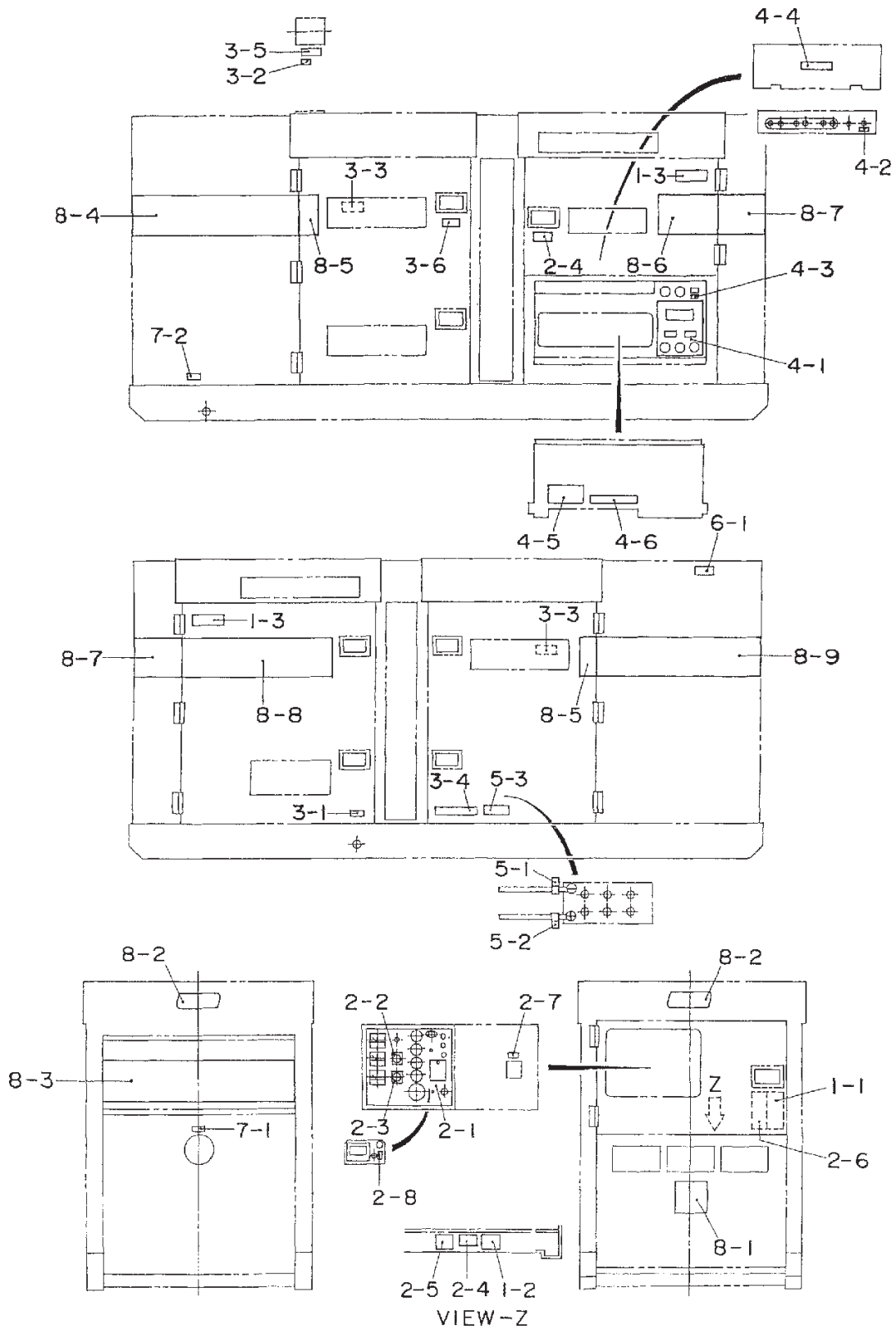

## NAMEPLATE AND DECALS ASSY.

### NAME PLATE ASSY.

<u>NO.</u>	<u>PART NO.</u>	<u>PART NAME</u>	<u>QTY.</u>	<u>REMARKS</u>
1	0229201240	RUBBER SEAL	4	
1-1	M4550000303	DECAL; OPERATING PROCEDURES	1	M45000030
1-2	M9520100304	DECAL; SAFETY INSTRUCTIONS	1	M92010030
1-3	M9520100603	DECAL; CAUTION	2	M92010060
2-1	M3550002702	DECAL; CONTROL PANEL	1	M35000270
2-2	M9520000104	PLATE; AMMETER CHANGE-OVER SWITCH	1	M92000010
2-3	M9520000204	PLATE; VOLTMETER CHANGE-OVER SWITCH	1	M92000020
2-4	M9520100004	DECAL; WARNING ELECTRIC SHOCK HARD.	2	M92010000
2-5	M9520200404	DECAL; OVER CURRENT RELAY	1	M92020040
2-6	M9520200303	DECAL; SETTING FOR OUTPUT VOLTAGE	1	M92020030
2-7	M9522000504	DECAL; CIRCUIT BREAKER	1	M92200050
2-8	M9520000904	DECAL; DIAGNOSTIC SWITCH	1	M92000090
3-1	M9500000004	DECAL; OIL DRAIN PLUG	1	M90000000
3-2	M9500100004	DECAL; WATER	1	M90010000
3-3	M9503000004	DECAL; WARNING ROTATING PARTS	2	M90300000
3-4	M9503000103	DECAL; WARNING- OIL CHECK	1	M90300010
3-5	M9503100004	DECAL; WARNING HOT COOLANT	1	M90310000
3-6	M9510100004	DECAL; CAUTION HOT PARTS	1	M91010000
4-1	M4550000503	DECAL; RECEPTACLE & CIRCUIT BREAKER	1	M45000050
4-2	M9520000004	DECAL; GROUND	1	M92000000
4-3	M9520000504	DECAL; START CONTACT	1	M92000050
4-4	M9520000704	DECAL; 3-PHASE OUTPUT TERMINAL	1	M92000070
4-5	M9520100404	DECAL; DANGER HIGH VOLTAGE	1	M92010040
4-6	M9520100503	DECAL; WARNING	1	M92010050
5-1	M9500300004	DECAL; -	1	M90030000
5-2	M9500300104	DECAL; +	1	M90030010
5-3	M9510100403	DECAL; CAUTION	1	M91010040
6-1	M9503200004	DECAL; WARNING ENGINE EXHAUST	1	M90320000
7-1	M9500500004	DECAL; DIESEL FUEL	1	M95005000
7-2	M9500500104	DECAL; FUEL DRAIN PLUG	1	M90050010
8-1	M9510200002	DECAL; MQ	1	M91020000
8-2	0600500090	EMBLEM	2	
8-2A	0021106016	MACHINE SCREW	4	
8-3	M4560101103	STRIPE	2	
8-4	M4560101203	STRIPE	1	
8-5	M4560100904	STRIPE	2	
8-6	M3560103004	STRIPE	1	
8-7	M4560100704	STRIPE	2	
8-8	M3560102903	STRIPE	1	
8-9	M4560101003	STRIPE	1	

# TERMS AND CONDITIONS OF SALE — PARTS

## PAYMENT TERMS

Terms of payment for parts are net 30 days.

## FREIGHT POLICY

All parts orders will be shipped collect or prepaid with the charges added to the invoice. All shipments are F.O.B. point of origin. Multiquip's responsibility ceases when a signed manifest has been obtained from the carrier, and any claim for shortage or damage must be settled between the consignee and the carrier.

## MINIMUM ORDER

The minimum charge for orders from Multiquip is \$15.00 net. Customers will be asked for instructions regarding handling of orders not meeting this requirement.

## RETURNED GOODS POLICY

Return shipments will be accepted and credit will be allowed, subject to the following provisions:

1. A Returned Material Authorization must be approved by Multiquip prior to shipment.
2. To obtain a Return Material Authorization, a list must be provided to Multiquip Parts Sales that defines item numbers, quantities, and descriptions of the items to be returned.
  - a. The parts numbers and descriptions must match the current parts price list.
  - b. The list must be typed or computer generated.
  - c. The list must state the reason(s) for the return.
  - d. The list must reference the sales order(s) or invoice(s) under which the items were originally purchased.
  - e. The list must include the name and phone number of the person requesting the RMA.
3. A copy of the Return Material Authorization must accompany the return shipment.
4. Freight is at the sender's expense. All parts must be returned freight prepaid to Multiquip's designated receiving point.

5. Parts must be in new and resalable condition, in the original Multiquip package (if any), and with Multiquip part numbers clearly marked.
6. The following items are not returnable:
  - a. Obsolete parts. (If an item is in the price book and shows as being replaced by another item, it is obsolete.)
  - b. Any parts with a limited shelf life (such as gaskets, seals, "O" rings, and other rubber parts) that were purchased more than six months prior to the return date.
  - c. Any line item with an extended dealer net price of less than \$5.00.
  - d. Special order items.
  - e. Electrical components.
  - f. Paint, chemicals, and lubricants.
  - g. Decals and paper products.
  - h. Items purchased in kits.
7. The sender will be notified of any material received that is not acceptable.
8. Such material will be held for five working days from notification, pending instructions. If a reply is not received within five days, the material will be returned to the sender at his expense.
9. Credit on returned parts will be issued at dealer net price at time of the original purchase, less a 15% restocking charge.
10. In cases where an item is accepted, for which the original purchase document can not be determined, the price will be based on the list price that was effective twelve months prior to the RMA date.
11. Credit issued will be applied to future purchases only.

## PRICING AND REBATES

Prices are subject to change without prior notice. Price changes are effective on a specific date and all orders received on or after that date will be billed at the revised price. Rebates for price declines and added charges for price increases will not be made for stock on hand at the time of any price change.

Multiquip reserves the right to quote and sell direct to Government agencies, and to Original Equipment Manufacturer accounts who use our products as integral parts of their own products.

## SPECIAL EXPEDITING SERVICE

A \$35.00 surcharge will be added to the invoice for special handling including bus shipments, insured parcel post or in cases where Multiquip must personally deliver the parts to the carrier.

## LIMITATIONS OF SELLER'S LIABILITY

Multiquip shall not be liable hereunder for damages in excess of the purchase price of the item with respect to which damages are claimed, and in no event shall Multiquip be liable for loss of profit or good will or for any other special, consequential or incidental damages.

## LIMITATION OF WARRANTIES

No warranties, express or implied, are made in connection with the sale of parts or trade accessories nor as to any engine not manufactured by Multiquip. Such warranties made in connection with the sale of new, complete units are made exclusively by a statement of warranty packaged with such units, and Multiquip neither assumes nor authorizes any person to assume for it any other obligation or liability whatever in connection with the sale of its products. Apart from such written statement of warranty, there are no warranties, express, implied or statutory, which extend beyond the description of the products on the face hereof.

Effective: February 22, 2006

**NOTES**

# OPERATION AND PARTS MANUAL

## HERE'S HOW TO GET HELP

PLEASE HAVE THE MODEL AND SERIAL  
NUMBER ON-HAND WHEN CALLING

### ***MULTIQUIP CORPORATE OFFICE***

18910 Wilmington Ave      Tel. (800) 421-1244  
Carson, CA 90746      Fax (800) 537-3927  
Contact: mq@multiquip.com  
Web: www.multiquip.com

### ***MQ Power***

1800 Water Ridge Rd.      Tel. (800) 883-2551  
Suite 500/600      Fax (972) 315-1847  
Lewisville, TX 75057  
Contact: mqpower@multiquip.com  
Web: www.mqpower.com

### ***MQ Parts Department***

800-427-1244      Fax: 800-672-7877  
310-537-3700      Fax: 310-637-3284

### ***Service/Tech Support/Warranty***

800-835-2551      Fax: 310-638-8046

© COPYRIGHT 2000, MULTIQUIP INC.

MQ Power and the MQ Power logo are registered trademarks of Multiquip Inc. and may not be used, reproduced, or altered without written permission. All other trademarks are the property of their respective owners and used with permission.

This manual MUST accompany the equipment at all times. This manual is considered a permanent part of the equipment and should remain with the unit if resold.

The information and specifications included in this publication were in effect at the time of approval for printing. Illustrations, descriptions, references and technical data contained in this manual are for guidance only and may not be considered as binding. Multiquip Inc. reserves the right to discontinue or change specifications, design or the information published in this publication at any time without notice and without incurring any obligations.

Further, MQ Power disclaims any warranties or guaranties, expressed or implied, with regards to the information contained in this manual.

Your Local Dealer is:

Manufactured for  
Multiquip Inc.  
by  
DENYO CO., LTD, JAPAN<sup>®</sup>

