

Protector™ Series

Diesel Generator Set

INCLUDES:

- Two Line LCD Multilingual Digital Evolution™ Controller (English/Spanish/French/Portuguese) with external viewing window for easy indication of generator status and breaker position.
- Isochronous electronic governor
- Sound attenuated aluminum enclosure
- Smart battery charger
- UV / Ozone resistant hoses
- ±1% voltage regulation
- Integrated base tank options are available with run times over 90 hours without having to refuel*
- Five year limited warranty
- UL 2200 / UL142 / ULC S601 Listed
- Meets code requirements for external vent and fill

Standby Power Rating

Model RD015 - 15 kW 60 Hz
 Model RD020 - 20 kW 60 Hz
 Model RD030 - 30 kW 60 Hz
 Model RD048 - 48 kW 60 Hz (single-phase only)
 Model RD050 - 50 kW 60 Hz (three-phase only)



QUIET-TEST



*Assembled in the USA using domestic and foreign parts

Meets EPA Emission Regulations
 CA/MA Emissions Compliant

* Time calculated at one-half maximum kW output.

FEATURES

- **INNOVATIVE DESIGN & PROTOTYPE TESTING** are key components of GENERAC'S success in "IMPROVING POWER BY DESIGN." But it doesn't stop there. Total commitment to component testing, reliability testing, environmental testing, destruction and life testing, plus testing to applicable CSA, NEMA, EGSA, and other standards, allows you to choose GENERAC POWER SYSTEMS with the confidence that these systems will provide superior performance.
- **TEST CRITERIA:**
 - ✓ PROTOTYPE TESTED
 - ✓ SYSTEM TORSIONALTESTED
 - ✓ NEMA MG1-22 EVALUATION
 - ✓ MOTOR STARTING ABILITY
- **TRUE POWER™ ELECTRICAL TECHNOLOGY:** Superior harmonics and sine wave form produce less than 5% Total Harmonic Distortion for utility quality power. This allows confident operation of sensitive electronic equipment and micro-chip based appliances, such as variable speed HVAC systems.
- **SOLID-STATE, FREQUENCY COMPENSATED VOLTAGE REGULATION:** This state-of-the-art power maximizing regulation system is standard on all Generac models. It provides optimized FAST RESPONSE to changing load conditions and MAXIMUM MOTOR STARTING CAPABILITY by electronically torque-matching the surge loads to the engine. Digital voltage regulation at ±1%.
- **SINGLE SOURCE SERVICE RESPONSE** from Generac's extensive dealer network provides parts and service know-how for the entire unit, from the engine to the smallest electronic component.
- **GENERAC TRANSFER SWITCHES:** Long life and reliability are synonymous with GENERAC POWER SYSTEMS. One reason for this confidence is that the GENERAC product line includes its own transfer systems and controls for total system compatibility.

15 • 20 • 30 • 48 • 50 kW

Application and Engineering Data

GENERATOR SPECIFICATIONS

| | |
|-------------------------------------|---------------------------------------|
| Type | Synchronous |
| Rotor Insulation Class | H (15 & 20 kW) or F (30, 48, & 50 kW) |
| Stator Insulation Class | H |
| Telephone Interference Factor (TIF) | <50 |
| Alternator Output Leads 1-Phase | Three wire |
| Alternator Output Leads 3-Phase | Six wire |
| Bearings | Single Sealed Cartridge |
| Coupling | Direct, Flexible Disc |
| Excitation System | Direct |
| Total Harmonic Distortion | < 5% |

VOLTAGE REGULATION

| | |
|------------|---------------------------|
| Type | Electronic |
| Sensing | Single-phase |
| Regulation | ± 1% |
| Features | Adjustable voltage & gain |

GOVERNOR SPECIFICATIONS

| | |
|-------------------------|------------------------|
| Type | Electronic isochronous |
| Steady State Regulation | ± 0.25% |

ELECTRICAL SYSTEM

| | |
|--|--|
| Battery Charge Alternator | 50 amp (15 & 20 kW), 65 amp (30 kW), and 50 amp (48 & 50 kW) |
| Static Battery Charger | 2 amp |
| Recommended Battery (battery not included) | Group 27F, 700 CCA Group 31, 925 CCA batteries can also be used with 30kW units |
| System Voltage | 12 volts |

ALTERNATOR SPECIFICATIONS

Revolving field heavy duty generator
 Directly connected to the engine
 Operating temperature rise 120 °C above a 40 °C ambient
 Class H insulation is NEMA rated
 Class F insulation is NEMA rated
 All models fully prototype tested

ENCLOSURE FEATURES

| | |
|---------------------------------------|--|
| Aluminum weather protective enclosure | Provides protection against mother nature. Electrostatically applied textured epoxy paint for added durability. |
| Enclosed critical grade muffler | Quiet, critical grade muffler is mounted inside the unit to prevent injuries and maximize sound dampening. |
| Small, compact, attractive | Makes for an easy, eye appealing installation. |
| SAE | Sound attenuated enclosure ensures quiet operation. |

ENGINE SPECIFICATIONS: 15 & 20 kW

| | |
|-----------------------|---------------------|
| Make | Mitsubishi |
| Model | In-line |
| Cylinders | 4 |
| Displacement (Liters) | 2.5 |
| Bore (in / mm) | 3.46 / 88 |
| Stroke (in / mm) | 4.06 / 103 |
| Compression Ratio | 22:1 |
| Intake Air System | Naturally aspirated |
| Cylinder Head Type | Cast iron OHV |
| Piston Type | Aluminum |

ENGINE SPECIFICATIONS: 30 kW

| | |
|-----------------------|----------------------------|
| Make | Perkins |
| Model | In-line |
| Cylinders | 4 |
| Displacement (Liters) | 2.2 |
| Bore (in / mm) | 3.30 / 84 |
| Stroke (in / mm) | 3.94 / 100 |
| Compression Ratio | 23.3:1 |
| Intake Air System | Turbocharged / aftercooled |
| Cylinder Head Type | Cast iron OHV |
| Piston Type | Aluminum |

ENGINE SPECIFICATIONS: 48 & 50 kW

| | |
|-----------------------|----------------------------|
| Make | Mitsubishi |
| Model | In-line |
| Cylinders | 4 |
| Displacement (Liters) | 3.3 |
| Bore (in / mm) | 3.70 / 94 |
| Stroke (in / mm) | 4.72 / 120 |
| Compression Ratio | 19:1 |
| Intake Air System | Turbocharged / Aftercooled |
| Cylinder Head Type | Cast iron OHV |
| Piston Type | Aluminum |

ENGINE LUBRICATION SYSTEM

| | |
|--------------------------------------|----------------------------|
| Oil Pump Type | Gear |
| Oil Filter Type | Full flow spin-on canister |
| Crankcase Capacity (quarts / Liters) | 6.87 / 6.5—15 & 20 kW |
| | 11.2 / 10.6—30 kW |
| | 11.6 / 11—48 & 50 kW |

ENGINE COOLING SYSTEM

| | |
|------------------------|--------------------------|
| Water Pump | Pre-lubed, self-sealing |
| Fan Speed (rpm) | 2376—15 & 20 kW |
| | 1980—30 kW |
| | 2340—48 & 50 kW |
| Fan Diameter (in / mm) | 18.11 / 460 (15 & 20 kW) |
| | 18 / 457.2 (30 kW) |
| | 17 / 431.8 (48 & 50 kW) |
| Fan Mode | Pusher |

FUEL SYSTEM

| | |
|----------------------------|-------------------------------|
| Fuel Type | Ultra low sulfur diesel fuel |
| Fuel Pump Type | Mechanical engine driven gear |
| Injector Type | Mechanical |
| Fuel Supply Line (mm / in) | 7.94 / 0.31 (ID) |
| Fuel Return Line (mm / in) | N/A—15 & 20 kW |
| | 4.76 / 0.19 (ID)—30 kW |
| | 7.94 / 0.31 (ID)—48 & 50 kW |
| Fuel Specification | ASTM |
| Fuel Filtering (microns) | 6—15 & 20 kW |
| | 25—30 kW |
| | 6—48 & 50 kW |

WEIGHTS AND DIMENSIONS

| kW size | Tank size | Weight (lb / kg) | Dimensions (L x W x H) (in / cm) |
|------------|-----------|------------------|----------------------------------|
| 15 kW | 32 Gal | 1528 / 693 | 81 x 31 x 51 / 206 x 79 x 129 |
| | 95 Gal | 1757 / 797 | 81 x 31 x 61 / 206 x 79 x 165 |
| 20 kW | 32 Gal | 1528 / 693 | 81 x 31 x 51 / 206 x 79 x 129 |
| | 95 Gal | 1757 / 797 | 81 x 31 x 61 / 206 x 79 x 165 |
| 30 kW | 57 Gal | 1857 / 842 | 95 x 35 x 59 / 241 x 89 x 150 |
| | 132 Gal | 2070 / 939 | 95 x 35 x 68 / 241 x 89 x 173 |
| 48 & 50 kW | 57 Gal | 2215 / 1102 | 95 x 35 x 57 / 241 x 89 x 145 |
| | 132 Gal | 2429 / 1102 | 95 x 35 x 66 / 241 x 89 x 168 |

15 • 20 • 30 • 48 • 50 kW

Application and Engineering Data

TANK SPECIFICATIONS

| kW size | | Total Capacity | | Usable Capacity | | Run Time at 1/2 Load (hrs) | |
|------------|--------------|----------------|---------|-----------------|---------|----------------------------|-----|
| | | gal / L | gal / L | gal / L | gal / L | hrs | hrs |
| 15 kW | 32 Gal Tank | 32 | 127 | 32 | 121 | 39 | |
| | 95 Gal Tank | 98.5 | 372.9 | 95 | 359.6 | 115.8 | |
| 20 kW | 32 Gal Tank | 32 | 127 | 32 | 121 | 31 | |
| | 95 Gal Tank | 98.5 | 372.9 | 95 | 359.6 | 92.2 | |
| 30 kW | 57 Gal Tank | 61 | 233 | 57 | 215 | 41.6 | |
| | 132 Gal Tank | 138.5 | 524 | 132 | 500 | 96.4 | |
| 48 & 50 kW | 57 Gal Tank | 62 | 234.7 | 57 | 215 | 28.2 | |
| | 132 Gal Tank | 138.5 | 524 | 132 | 500 | 65.3 | |

GENERATOR OUTPUT VOLTAGE / KW-60 HZ

| kW (standby) | Amp (standby) | kW (Prime) | Amp (Prime) | CB Size | Voltage | |
|--------------|---------------|------------|-------------|---------|-----------------------|-----------|
| | | | | | 120/240 V | 277/480 V |
| RD015 | 15 | 12 | 50 | 70 | 120/240 V, 1Ø, 1.0 pf | 62 |
| | | | | | 120/208 V, 3Ø, 0.8 pf | 52 |
| | | | | | 120/240 V, 3Ø, 0.8 pf | 45 |
| RD020 | 20 | 16 | 67 | 100 | 120/240 V, 1Ø, 1.0 pf | 83 |
| | | | | | 120/208 V, 3Ø, 0.8 pf | 69 |
| | | | | | 120/240 V, 3Ø, 0.8 pf | 60 |
| RD030 | 30 | 24 | 100 | 150 | 120/240 V, 1Ø, 1.0 pf | 125 |
| | | | | | 120/208 V, 3Ø, 0.8 pf | 104 |
| | | | | | 120/240 V, 3Ø, 0.8 pf | 90 |
| | | | | | 277/480 V, 3Ø, 0.8 pf | 45 |
| RD048 | 48 | 38.4 | 183 | 200 | 120/240 V, 1Ø, 1.0 pf | 200 |
| | | | | | 120/208 V, 3Ø, 0.8 pf | 173 |
| RD050 | 50 | 40 | 132 | 175 | 120/240 V, 3Ø, 0.8 pf | 150 |
| | | | | | 277/480 V, 3Ø, 0.8 pf | 75 |

SURGE CAPACITY IN AMPS

| Voltage | kW | Voltage Dip @ < 0.4 pf | |
|---------|---------------|------------------------|-----|
| | | 15% | 30% |
| | | 120/240 V, 1Ø | 53 |
| RD015 | 120/208 V, 3Ø | 37 | 90 |
| | 120/240 V, 3Ø | 32 | 78 |
| | 120/240 V, 1Ø | 87 | 211 |
| RD020 | 120/208 V, 3Ø | 59 | 143 |
| | 120/240 V, 3Ø | 51 | 124 |
| | 120/240 V, 1Ø | 66 | 168 |
| RD030 | 120/208 V, 3Ø | 59 | 144 |
| | 120/240 V, 3Ø | 51 | 125 |
| | 277/480 V, 3Ø | 26 | 64 |
| RD048 | 120/240 V, 1Ø | 69 | 189 |
| | 120/208 V, 3Ø | 90 | 218 |
| RD050 | 120/240 V, 3Ø | 78 | 189 |
| | 277/480 V, 3Ø | 36 | 87 |

ENGINE FUEL CONSUMPTION

| Load | kW | gal / hr | L / hr |
|----------------|--------------------|----------|--------|
| | | | |
| RD015 | 25% of rated load | 0.60 | 2.27 |
| | 50% of rated load | 0.85 | 3.22 |
| | 75% of rated load | 1.10 | 4.16 |
| | 100% of rated load | 1.46 | 5.53 |
| RD020 | 25% of rated load | 0.77 | 2.9 |
| | 50% of rated load | 1.03 | 3.90 |
| | 75% of rated load | 1.46 | 5.53 |
| | 100% of rated load | 1.97 | 7.46 |
| RD030 | 25% of rated load | 0.97 | 3.67 |
| | 50% of rated load | 1.37 | 5.19 |
| | 75% of rated load | 1.97 | 7.46 |
| | 100% of rated load | 2.77 | 10.49 |
| RD048 RD050 | 25% of rated load | 1.23 | 4.66 |
| | 50% of rated load | 2.02 | 7.66 |
| | 75% of rated load | 3.02 | 11.43 |
| | 100% of rated load | 4.02 | 15.22 |

15 • 20 • 30 • 48 • 50 kW

ENGINE COOLING

| | 15 kW | 20 kW | 30 kW | 48 kW & 50 kW |
|---|----------------|----------------|-----------------|-----------------|
| Air flow (inlet air including alternator and combustion air in cfm / cmm) | 2750 / 78 | 2750 / 78 | 2800 / 79 | 2824 / 80 |
| System coolant capacity (gal / Liters) | 3.0 / 11.4 | 3.0 / 11.4 | 2.5 / 9.5 | 3.0 / 11.4 |
| Heat rejection to coolant (BTU per hr / MJ per hr) | 95,220 / 100.5 | 95,220 / 100.5 | 128,638 / 135.7 | 135,900 / 143.4 |
| Maximum operation air temperature on radiator (°C / °F) | 50 / 122 | | | |
| Maximum ambient temperature (°C / °F) | 50 / 122 | | | |

COMBUSTION REQUIREMENTS

| | 15 kW | 20 kW | 30 kW | 48 kW & 50 kW |
|---------------------------------|------------|------------|----------|---------------|
| Flow at rated power (cfm / cmm) | 86.3 / 2.4 | 86.3 / 2.4 | 88 / 2.5 | 190 / 5.38 |

SOUND EMISSIONS

| | |
|---|----|
| Sound output in dB(A) at 23 ft (7 m) with generator in exercise mode* | 65 |
| Sound output in dB(A) at 23 ft (7 m) with generator operating at normal load* | 70 |

EXHAUST

| | 15 kW | 20 kW | 30 kW | 48 kW & 50 kW |
|---|-------------|-------------|-------------|---------------|
| Exhaust flow at rated output (cfm / cmm) | 98.88 / 2.8 | 98.88 / 2.8 | 296.6 / 8.4 | 448 / 12.7 |
| Exhaust temperature at rated output (°C / °F) | 482 / 900 | 482 / 900 | 499 / 930 | 499 / 930 |

ENGINE PARAMETERS

| | | | | |
|-----------------------|------|------|----|----|
| Rated Synchronous Rpm | 1800 | | | |
| HP at rated kW | 26.4 | 33.5 | 49 | 85 |

POWER ADJUSTMENT FOR AMBIENT CONDITIONS

Temperature Deration 3% for every 5 °C above 25 °C or 1.7% for every 5 °F above 77 °F
 Altitude Deration (15, 30, 48, and 50 kW) 1% for every 100 m above 915 m or 3% for every 1,000 ft above 3,000 ft
 Altitude Deration (20 kW) 1% for every 100 m above 305 m or 3% for every 1,000 ft above 1,000 ft

CONTROLLER FEATURES

2-Line Plain Text Multilingual LCD Display Simple user interface for ease of operation
 Mode Buttons: Auto Automatic Start on Utility failure. Programmable 7 day exerciser
 Manual Start with starter control, unit stays on. If utility fails, transfer to load takes place
 Off Stops unit. Power is removed. Control and charger still operate
 Ready to Run/Maintenance Message Standard
 Engine Run Hours Indication Standard
 Programmable start delay between 2-1500 seconds Standard (programmable by dealer only)
 Utility Voltage Loss/Return to Utility Adjustable From 140-171 V/190-216 V
 Future Set Capable Exerciser/Exercise Set Error Warning Standard
 Run/Alarm/Maintenance Logs 50 Events Each
 Engine Start Sequence Cyclic cranking: 16 sec on, 7 rest (90 sec maximum duration)
 Starter Lock-out Starter cannot re-engage until 5 seconds after engine has stopped
 Smart Battery Charger Standard
 Charger Fault/Missing AC Warning Standard
 Low Battery/Battery Problem Protection and Battery Condition Indication Standard
 Automatic Voltage Regulation with Over and Under Voltage Protection Standard
 Under-Frequency/Overload/Stepper Overcurrent Protection Standard
 Safety Fused/Fuse Problem Protection Standard
 Automatic Low Oil Pressure Standard
 Overcrank/Overspeed (@ 72 Hz)/rpm Sense Loss Shutdown Standard
 High Engine Temperature Shutdown Standard
 Internal Fault/Incorrect Wiring Protection Standard
 Common External Fault Capability Standard
 Field Upgradeable Firmware Standard
 Low Coolant Level Shutdown Standard

15 • 20 • 30 • 48 • 50 kW

D2.5L G2 32 Gal Tank (1 of 2)

Installation Drawings

- NOTES:**
- MINIMUM RECOMMENDED CONCRETE PAD SIZE: 1092 (43") WIDE X 1887 (74.3") LONG. ALL DIMENSIONS ARE TO THE CENTER OF GRAVITY.
 - ALLOW SUFFICIENT ROOM ON ALL SIDES OF THE GENERATOR FOR MAINTENANCE AND SERVICING. THIS UNIT MUST BE INSTALLED IN ACCORDANCE WITH CURRENT APPLICABLE NFPA 37 AND NFPA 70 STANDARDS AS WELL AS ANY OTHER FEDERAL, STATE, AND LOCAL CODES.
 - SEE SPECIFICATION SHEET OR OWNERS MANUAL.
 - ACCESSIBLE THROUGH CUSTOMER ACCESS ASSEMBLY DOOR ON REAR OF GENERATOR.
 - REMOVE THE REAR STUB-UP AND REAR ENCLOSURE COVER PANEL TO ACCESS THE REAR OF THE GENERATOR.
 - HIGH VOLTAGE CONNECTION INCLUDING AC LOAD LEAD CONDUIT CONNECTION, NEUTRAL CONNECTION, AND BATTERY CHARGER (20 VOLT AC (0.5 AMP MAX) CONNECTION).
 - LOW VOLTAGE CONNECTION INCLUDING TRANSFER SWITCH CONTROL WIRES AND ACCESSORY RELAY CONNECTION (CITY POWER).
 - RECIRCULATION OF DISCHARGE AIR AND/OR IMPROPER COOLING AIR FLOW.
 - SEE OWNERS MANUAL FOR LIFTING WARNINGS.
 - USE STANDARD SAFE TO LOOSE SPRESS.
 - MUST ALLOW FREE FLOW OF INTAKE AIR, DISCHARGE AIR AND EXHAUST. SEE SPEC SHEET FOR MINIMUM AIR FLOW AND MAXIMUM RESTRICTION REQUIREMENTS.
 - GENERATOR MUST BE INSTALLED SUCH THAT FRESH COOLING AIR IS AVAILABLE AND THAT DISCHARGE AIR FROM RADIATOR IS NOT RECIRCULATED.

WEIGHT DATA WITH EMPTY BASE TANK (SEE NOTE 5)

| SERVICE ITEM | 2.5L |
|--------------------------|-------------|
| OIL FILL CAP | RIGHT SIDE |
| OIL DIP STICK | RIGHT SIDE |
| OIL FILTER | RIGHT SIDE |
| OIL DRAIN HOSE | LEFT SIDE |
| RADIATOR DRAIN HOSE | LEFT SIDE |
| COOLANT RECOVERY BOTTLE | LEFT SIDE |
| RADIATOR FILL CAP ACCESS | ROOF |
| AIR CLEANER ELEMENT | LEFT SIDE |
| MUFFLER | FRONT |
| PAN BELT | EITHER SIDE |
| BATTERY | LEFT SIDE |

REFERENCE OWNERS MANUAL FOR PERIODIC REPLACEMENT PART LISTINGS.

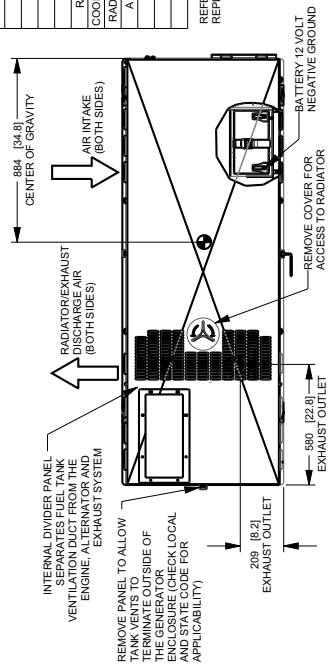

TOP VIEW

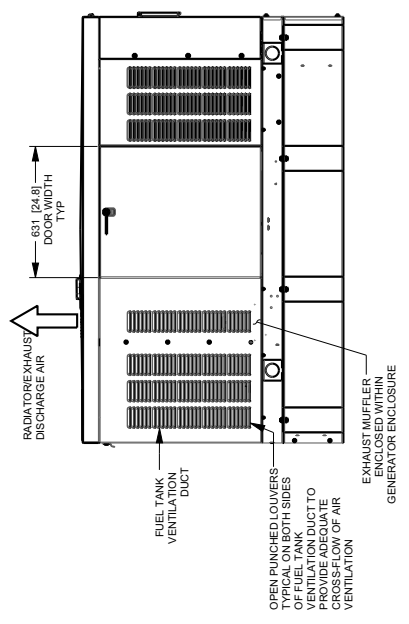

LEFT SIDE VIEW

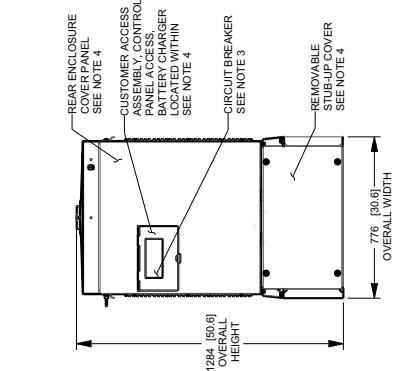

REAR VIEW

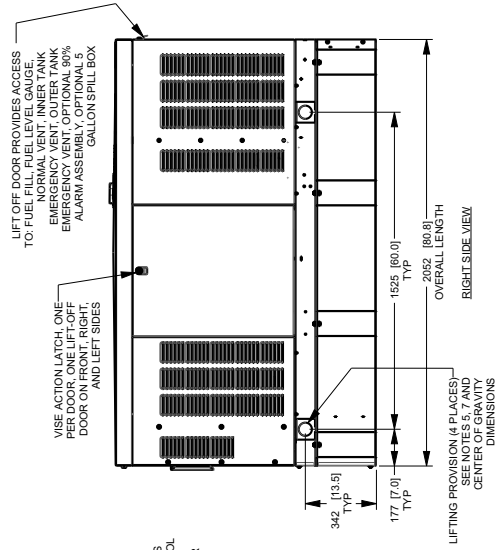

RIGHT SIDE VIEW

15 • 20 • 30 • 48 • 50 kW

D2.5L G2 32 Gal Tank (2 of 2)

| FUEL TANK | |
|-----------------|------------|
| TOTAL CAPACITY | 127 [33.5] |
| USABLE CAPACITY | 121 [32] |

CAPACITY: LITER (GALLON)
DIMENSIONS: MM (INCH)

TANK IS LISTED TO UL142 AND IJLC9601
NOTE: STUB-UP AREA FOR HIGH AND LOW VOLTAGE CONNECTIONS, CIRCUIT BREAKER, NEUTRAL AND CUSTOMER CONNECTION OPENING.

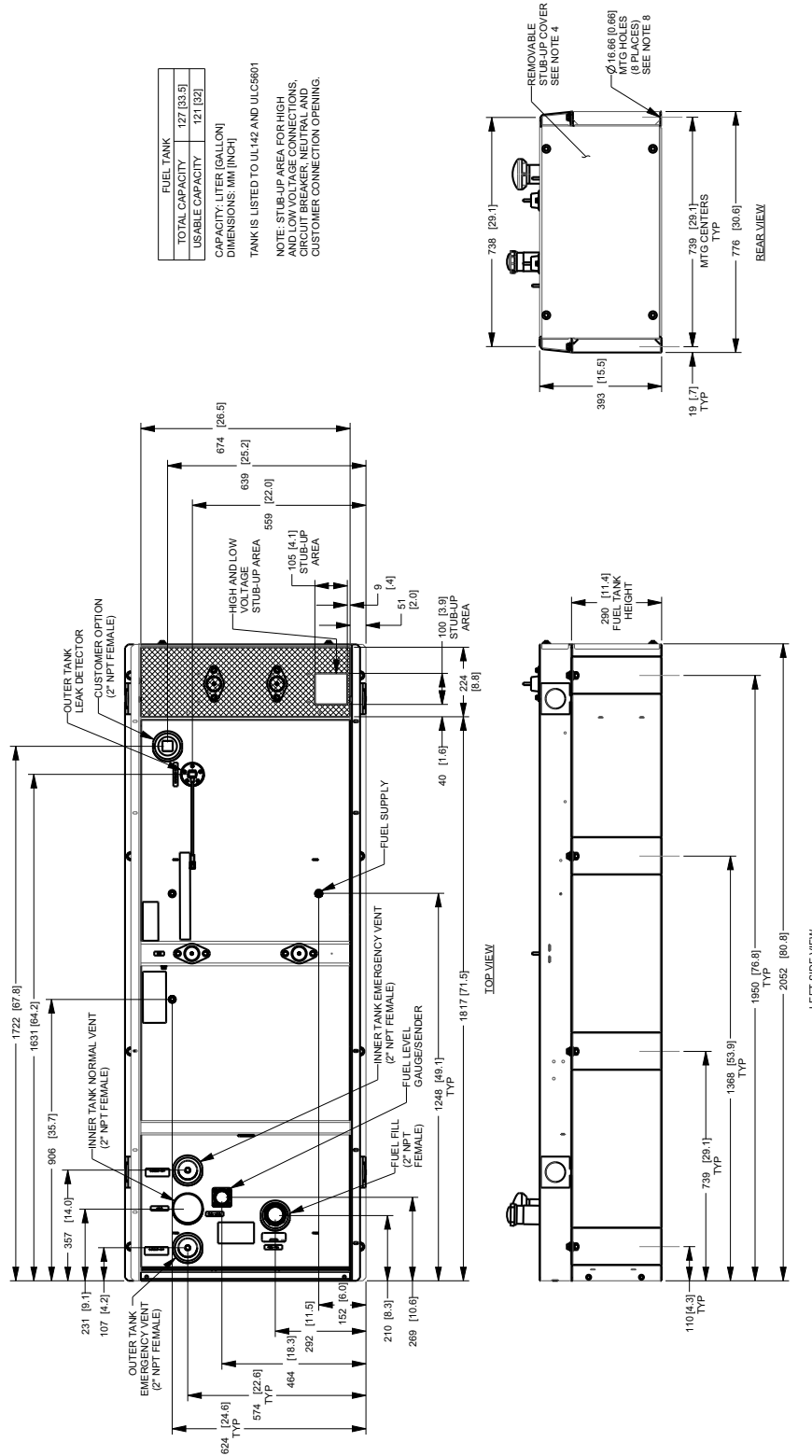

15 • 20 • 30 • 48 • 50 kW

D2.5L G2 95 Gal Tank (1 of 2)

Installation Drawings

- NOTES:
1. MINIMUM RECOMMENDED CONCRETE PAD SIZE - 1800 (48") WIDE X 1800 (48") LONG. REFER TO INSTALLATION GUIDE SUPPLIED WITH UNIT FOR CONCRETE PAD GUIDELINES.
 2. ALLOW SUFFICIENT ROOM ON ALL SIDES OF THE GENERATOR FOR MAINTENANCE AND SERVICING. THIS UNIT MUST BE INSTALLED IN ACCORDANCE WITH CURRENT APPLICABLE NFPA 37 AND NFPA 70 STANDARDS AS WELL AS ANY OTHER FEDERAL, STATE OR LOCAL REQUIREMENTS.
 3. CONTROL PANEL, CIRCUIT BREAKER INFORMATION - SEE SPECIFICATION SHEET OR OWNERS MANUAL.
 4. ACCESSIBLE THROUGH CUSTOMER ACCESS ASSEMBLY DOOR ON REAR OF GENERATOR.
 5. THE STUB-UP AREAS AS FOLLOWS:
 - HIGH VOLTAGE CONNECTION INCLUDING AC LOAD LEAD CONDUIT CONNECTION, NEUTRAL CONNECTION, AND BATTERY CHARGER (20 VOLT AC (0.5 AMP MAX) CONNECTION).
 - LOW VOLTAGE CONNECTION INCLUDING TRANSFER SWITCH CONTROL WIRES.
 6. CENTER OF GRAVITY AND WEIGHT MAY CHANGE DUE TO UNIT OPTIONS.
 7. RECIRCULATION OF DISCHARGE AIR AND/OR IMPROPER COOLING AIR FLOW.
 8. REFER TO MANUFACTURER'S INSTALLATION WARNINGS.
 9. MUST ALLOW FREE FLOW OF INTAKE AIR, DISCHARGE AIR AND EXHAUST. SEE SPEC SHEET FOR MINIMUM AIRFLOW AND MAXIMUM RESTRICTION REQUIREMENTS.
 10. DISCHARGE AIR FROM RADIATOR IS NOT RECIRCULATED AND THAT DISCHARGE AIR FROM RADIATOR IS NOT RECIRCULATED.

| SERVICE ITEM | 2.5L |
|--------------------------|-------------|
| OIL FILL CAP | RIGHT SIDE |
| OIL DIP STICK | RIGHT SIDE |
| OIL FILTER | RIGHT SIDE |
| OIL DRAIN HOSE | LEFT SIDE |
| RADIATOR DRAIN HOSE | LEFT SIDE |
| COOLANT RECOVERY BOTTLE | ROOF |
| RADIATOR FILL CAP ACCESS | FRONT |
| AIR CLEANER ELEMENT | FRONT |
| MUFFLER | EITHER SIDE |
| FAN BELT | EITHER SIDE |
| BATTERY | LEFT SIDE |

REFERENCE OWNERS MANUAL FOR PERIODIC REPLACEMENT PART LISTINGS.

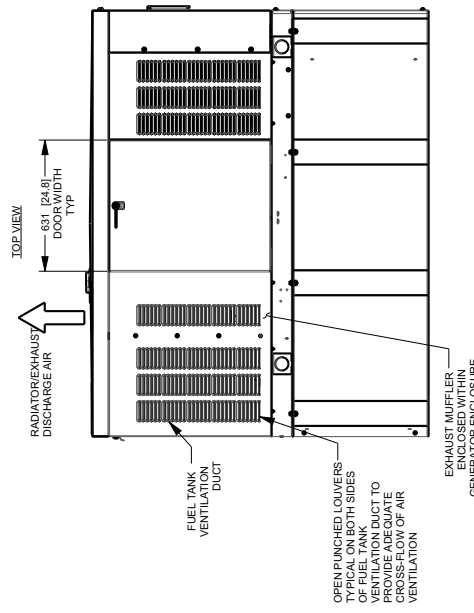
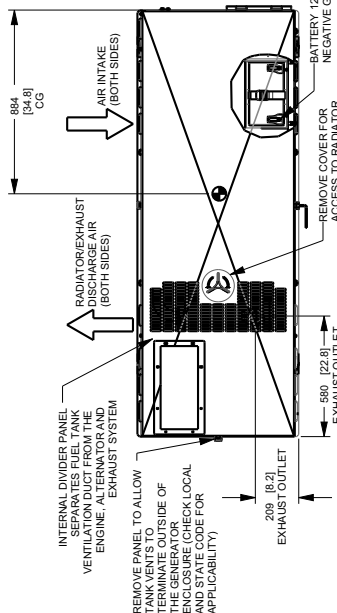

WEIGHT DATA WITH EMPTY BASE/TANK (SEE NOTE 5)

| GENERATOR AS SHOWN | 797 (175.7) |
|---------------------------|-------------|
| WITH WOODEN SHIPPING SKID | 835 (184.1) |
| WEIGHT: KG (LBS) | |
| DIMENSIONS: MM (INCH) | |

REFERENCE OWNERS MANUAL FOR PERIODIC REPLACEMENT PART LISTINGS.

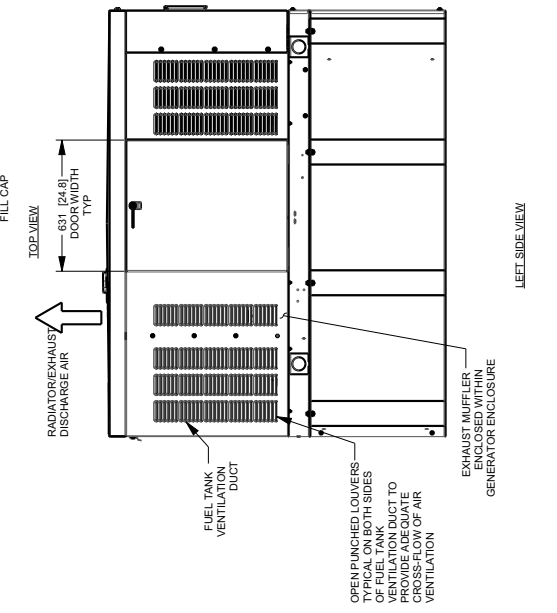
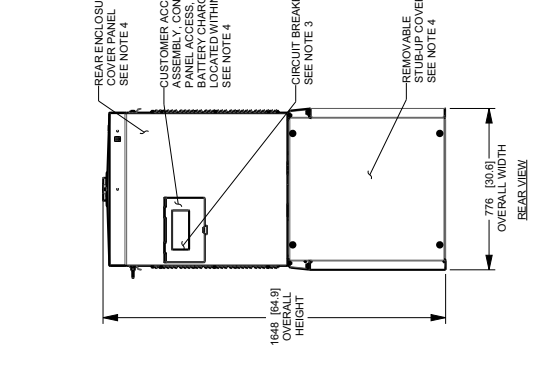
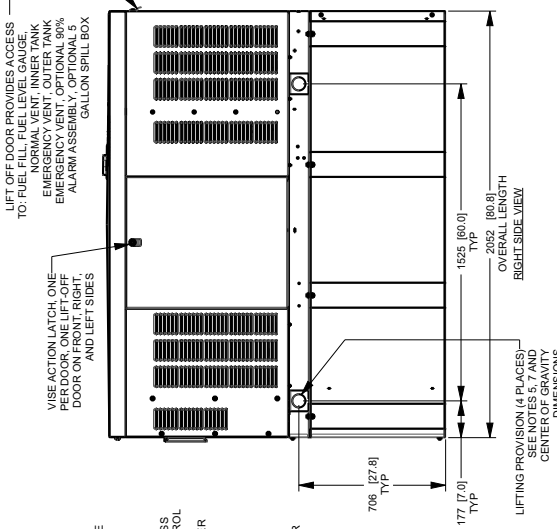

15 • 20 • 30 • 48 • 50 kW

D2.5L G2 95 Gal Tank (2 of 2)

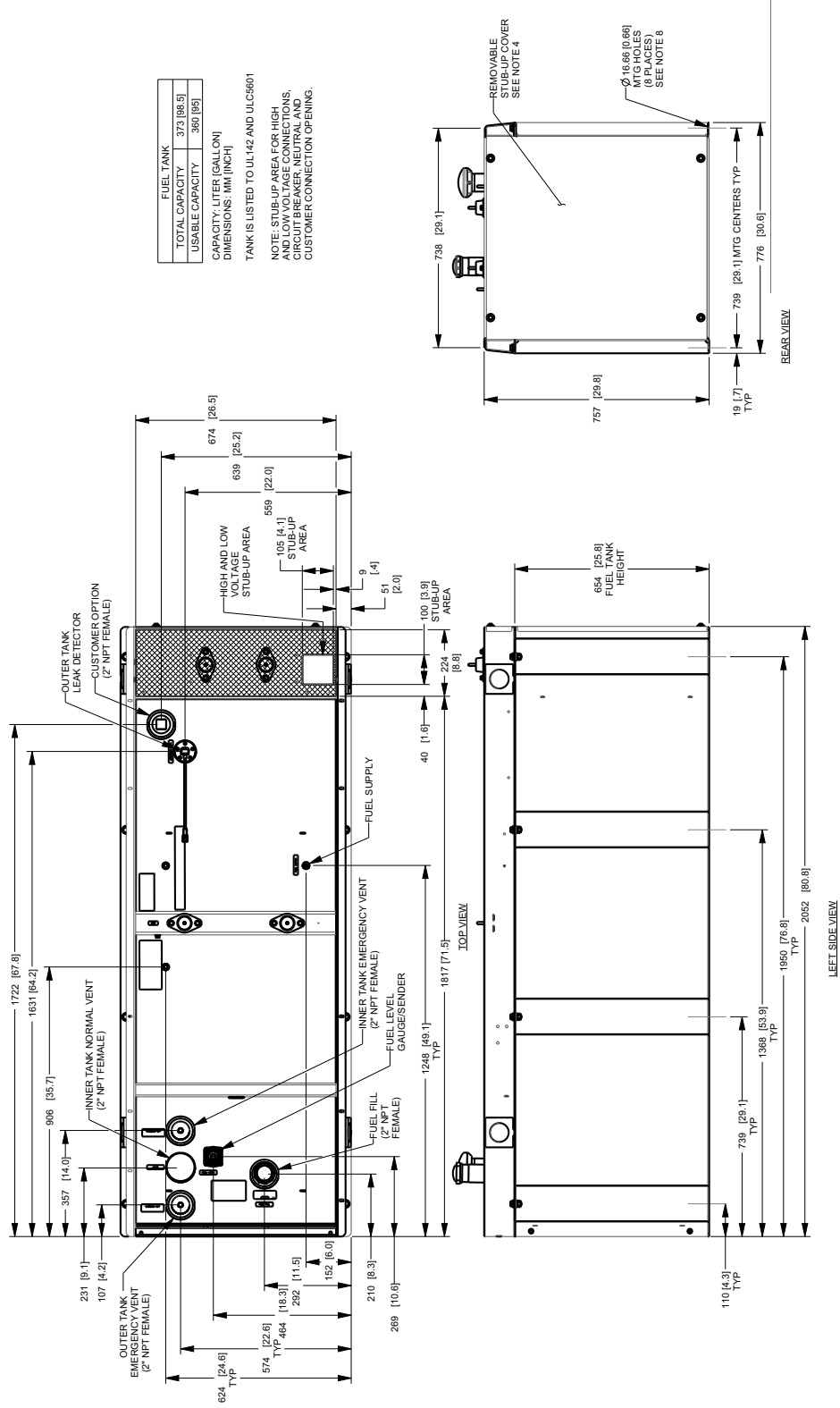

15 • 20 • 30 • 48 • 50 kW

D2.2L G22 57 Gal Tank (1 of 2)

| SERVICE ITEM | 2.2L |
|--------------------------|------------|
| OIL FILL CAP | RIGHT SIDE |
| OIL DIP STICK | RIGHT SIDE |
| OIL FILTER | RIGHT SIDE |
| OIL DRAIN HOSE | RIGHT SIDE |
| RADIATOR DRAIN HOSE | LEFT SIDE |
| COOLANT RECOVERY BOTTLE | LEFT SIDE |
| RADIATOR FILL CAP ACCESS | ROOF |
| AIR CLEANER ELEMENT | RIGHT SIDE |
| MUFFLER | FRONT SIDE |
| FAN BELT | LEFT SIDE |
| BATTERY | LEFT SIDE |

REFERENCE OWNERS MANUAL FOR PERIODIC REPLACEMENT PART LISTINGS

WEIGHT DATA WITH EMPTY BASE TANK (SEE NOTE 5)

| | |
|---------------------------|------------|
| GENERATOR AS SHOWN | 842 (1857) |
| WITH WOODEN SHIPPING SKID | 888 (1957) |

W/ WOODEN SHIPPING SKID 888 (1957)
DIMENSIONS: MM (INCH)

NOTES:

- MINIMUM RECOMMENDED CONCRETE PAD SIZE: 1184 (47") WIDE X 2261 (89") LONG. MINIMUM RECOMMENDED CONCRETE CURB HEIGHT: 100 (4") SUPPLIED WITH UNIT FOR CONCRETE PAD GUIDELINES.
- ALLOW SUFFICIENT ROOM ON ALL SIDES OF THE GENERATOR FOR MAINTENANCE AND SERVICING. THIS UNIT MUST BE INSTALLED IN ACCORDANCE WITH CURRENT NATIONAL, STATE AND LOCAL CODES.
- CONTROL PANEL / CIRCUIT BREAKER INFORMATION:
- SEE SPECIFICATION SHEET OR OWNERS MANUAL
- ACCESSIBLE THROUGH CUSTOMER ACCESS ASSEMBLY DOOR ON REAR OF THE STUB-UP AREAS AS FOLLOWS:
- HIGH VOLTAGE CONNECTIONS INCLUDING AC LOAD LEAD CONDUIT CONNECTIONS AND RE-CIRCULATION OF DISCHARGE AIR AND/OR IMPROPER COOLING AIR FLOW.
- LOW VOLTAGE CONNECTIONS INCLUDING TRANSFER SWITCH CONTROL WIRES
- ENGINE SERVICE CONNECTIONS
- OIL DRAIN: 3/8" NPT
- AIR INTAKE: 7" O.D.
- BOTTOM OF GENERATOR SET MUST BE ENCLOSED TO PREVENT PEST INTRUSION AND AND RE-CIRCULATION OF DISCHARGE AIR AND/OR IMPROPER COOLING AIR FLOW.
8. REFERENCE OWNERS MANUAL FOR LIFTING WARNINGS.
9. CONCRETE CURB OR CURB CONCRETE PAD SHALL BE 508-11 GRADE 5 (USE STANDARD SIZE TORQUE SPECS)

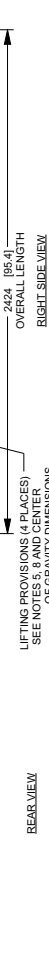
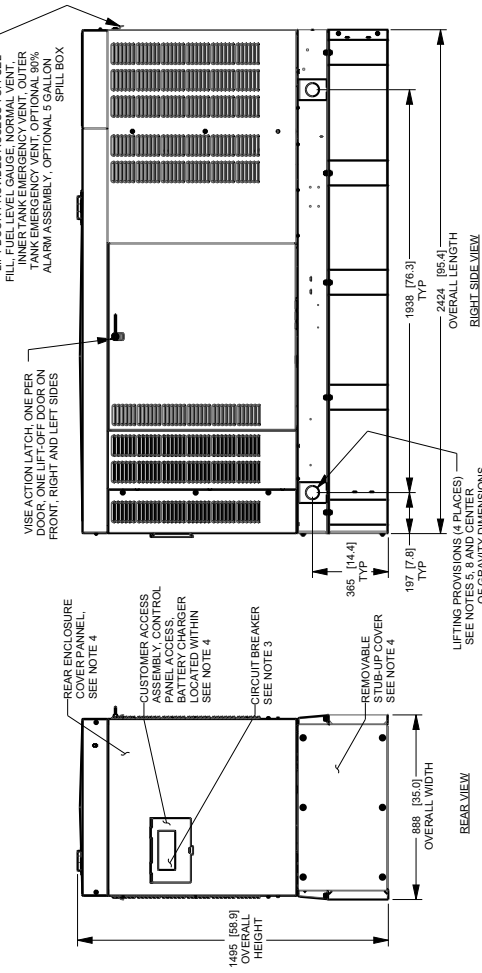
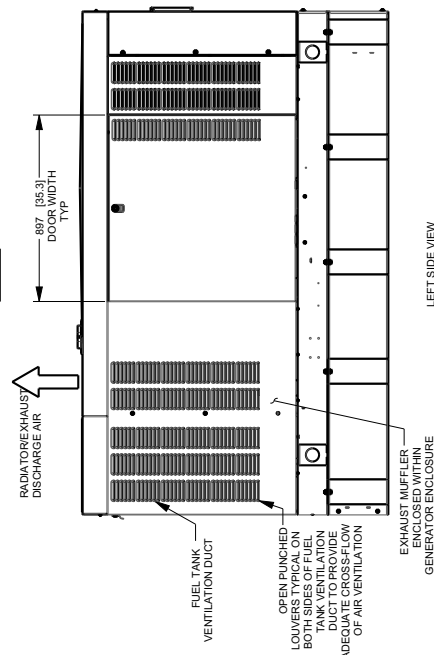
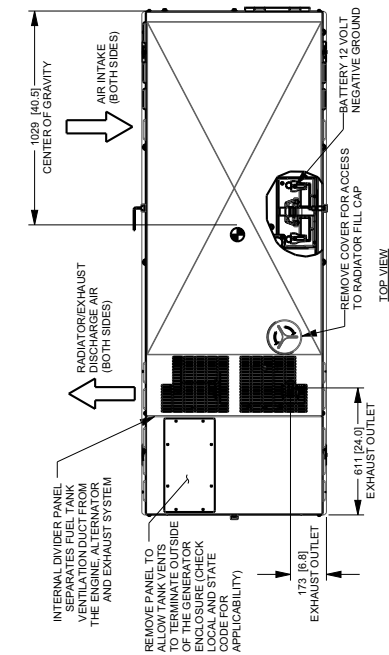

D2.2L G22 57 Gal Tank (2 of 2)

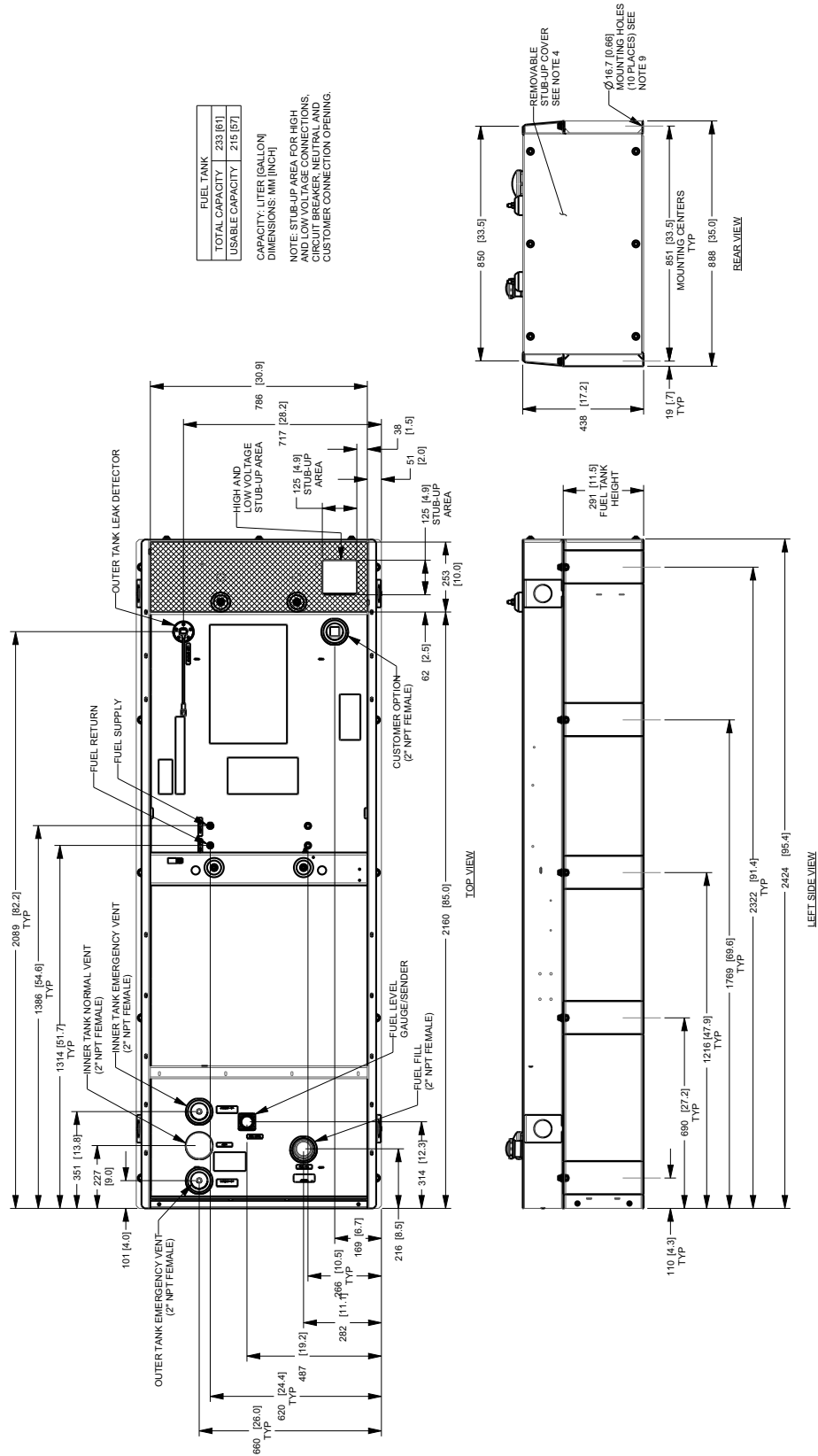

D2.2L G22 132 Gal Tank (1 of 2)

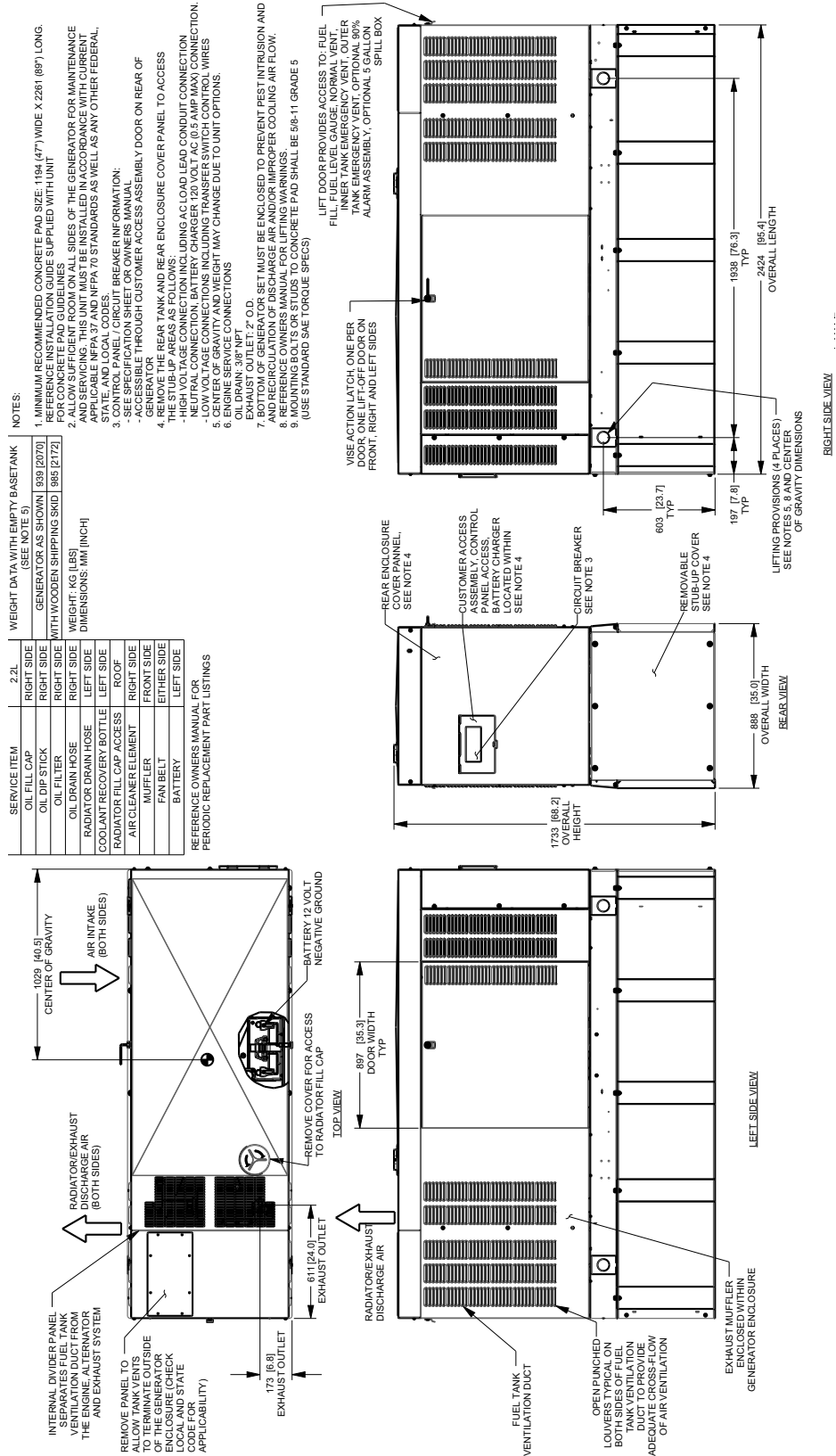

15 • 20 • 30 • 48 • 50 kW

D2.2L G22 132 Gal Tank (2 of 2)

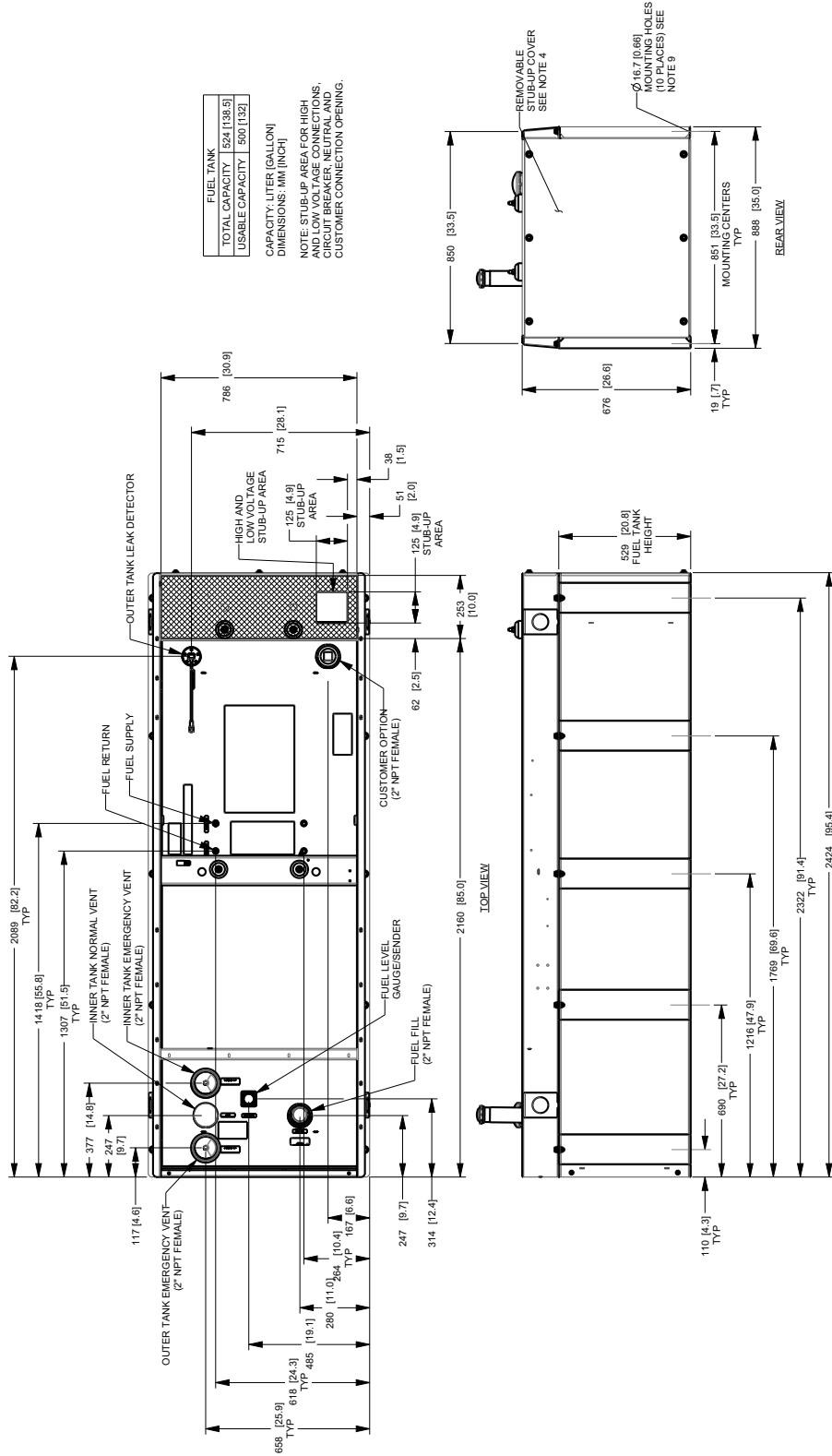

15 • 20 • 30 • 48 • 50 kW

D3.3L 57 Gal Tank (1 of 2)

Installation Drawings

NOTES:

1. MINIMUM RECOMMENDED CONCRETE PAD SIZE: 1194 (47") WIDE X 2718 (107") LONG. REFERENCE INSTALLATION GUIDE SUPPLIED WITH UNIT
2. ALLOW SUFFICIENT ROOM ON ALL SIDES OF THE GENERATOR FOR MAINTENANCE AND SERVICING. THIS UNIT MUST BE INSTALLED IN ACCORDANCE WITH CURRENT APPLICABLE NFPA 37 AND NFPA 70 STANDARDS AS WELL AS ANY OTHER FEDERAL, STATE, AND LOCAL CODES.
3. SEE SPECIFICATION SHEET OR OWNERS MANUAL FOR BREAKER INFORMATION.
4. REMOVE THE REAR TANK AND REAR ENCLOSURE COVER PANEL TO ACCESS GENERATOR.
5. HIGH VOLTAGE CONNECTION INCLUDING AC LOAD LEAD CONDUIT CONNECTION NEUTRAL CONNECTION, BATTERY CHARGER 120 VOLT AC (0.5 AMP MAX) CONNECTION.
6. LOW VOLTAGE CONNECTIONS INCLUDING TRANSFER SWITCH CONTROL WIRES.
7. CENTER OF GRAVITY AND WEIGHT MAY CHANGE DUE TO UNIT OPTIONS.
8. SEE SPECIFICATION SHEET OR OWNERS MANUAL FOR WIRING CONNECTIONS.
9. EXHAUST OUTLET, 2" O.D.
10. BOTTOM OF GENERATOR SET MUST BE ENCLOSED TO PREVENT PEST INTRUSION AND AND RECIRCULATION OF DISCHARGE AIR AND/OR IMPROPER COOLING AIR FLOW.
11. REMOVE THE CHARGING SYSTEM AND BATTERY PACKS FROM THE UNIT.
12. MARKING THE CONCRETE PAD WITH THE CENTER OF GRAVITY DIMENSIONS.
13. MOUNTING BOLTS OR STUDS TO CONCRETE PAD SHALL BE 5/8"-11 GRADE 5 (USE STANDARD SAE TORQUE SPECS)

| SERVICE ITEM | 3.3L | WEIGHT DATA WITH EMPTY BASE TANK (SEE NOTE 5) |
|--------------------------|--------|---|
| OIL FILL CAP | LEFT | GENERATOR AS SHOWN 1005 [215] |
| OIL DIP STICK | LEFT | WITH WOODEN SHIPPING SKID 1030 [235] |
| OIL DRAIN HOSE | RIGHT | WEIGHT: KG (LBS) |
| RADIATOR DRAIN HOSE | RIGHT | DIMENSIONS: MM (INCH) |
| COOLANT RECOVERY BOTTLE | RIGHT | |
| RADIATOR FILL CAP ACCESS | ROOF | |
| AIR CLEANER ELEMENT | FRONT | |
| MUFFLER | FRONT | |
| FAN BELT | EITHER | |
| BATTERY | RIGHT | |

REFERENCE OWNERS MANUAL FOR PERIODIC REPLACEMENT PART LISTINGS

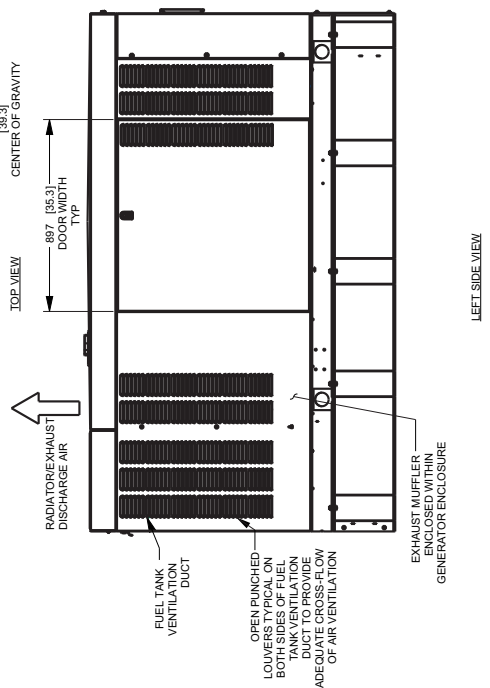
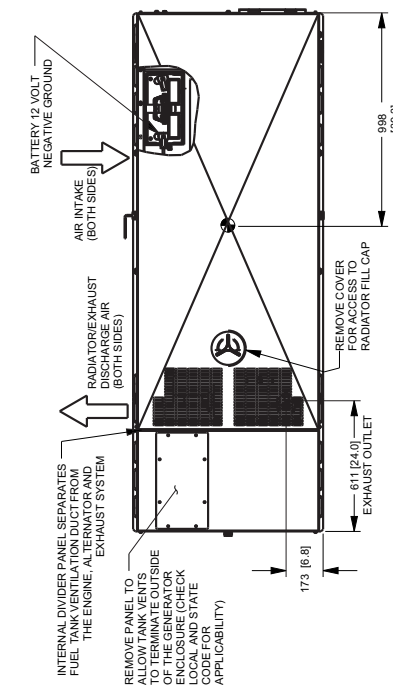

15 • 20 • 30 • 48 • 50 kW

D3.3L 57 Gal Tank (2 of 2)

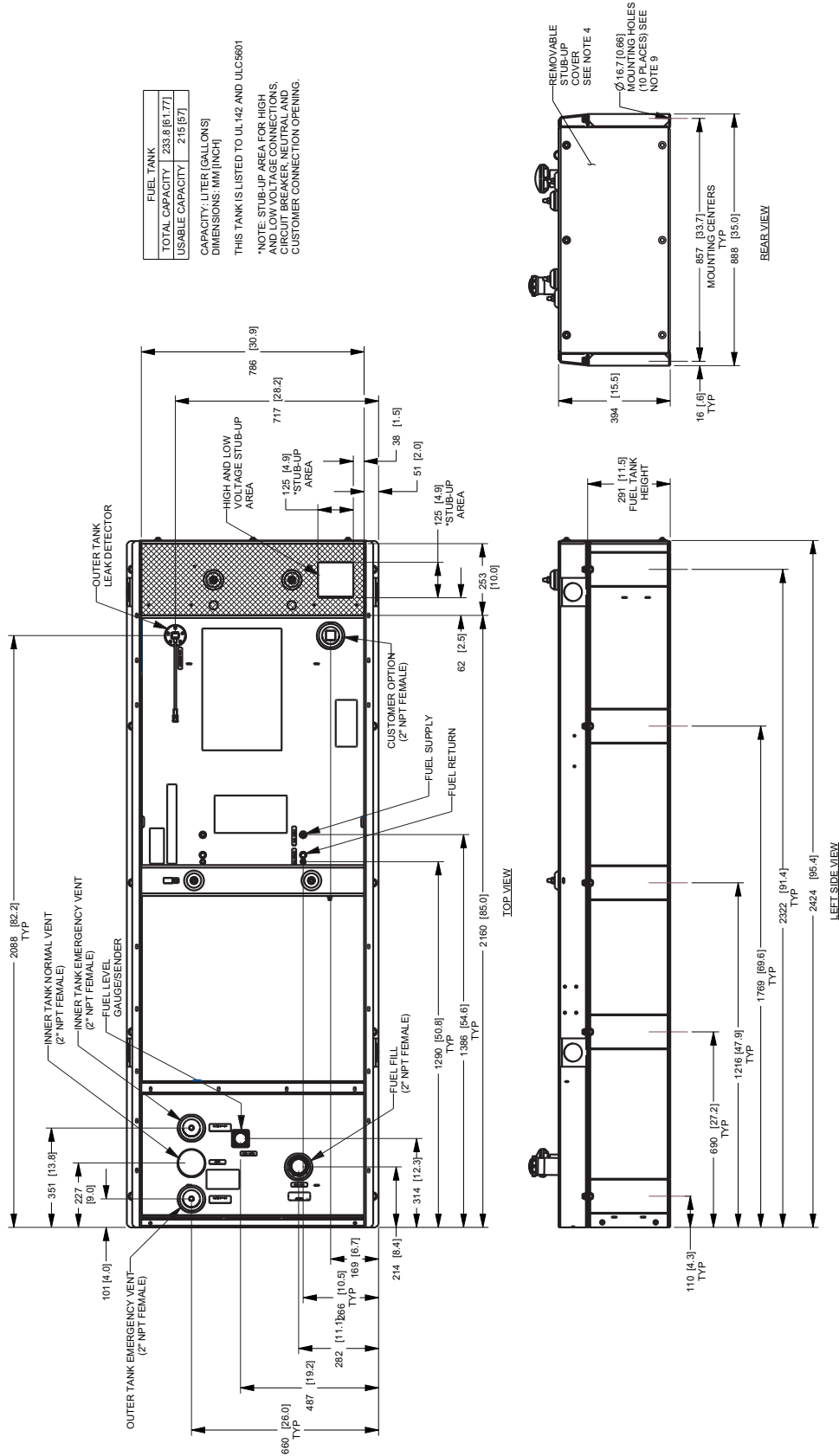

15 • 20 • 30 • 48 • 50 kW

D3.3L G16 132 Gal Tank (1 of 2)

| SERVICE ITEM | D3.3L | WEIGHT DATA WITH EMPTY BASE TANK (SEE NOTE 5) |
|--------------------------|--------|---|
| OIL FILL CAP | LEFT | GENERATOR AS SHOWN [102 (24.29)] |
| OIL DIP STICK | LEFT | WITH WOODEN SHIPPING SKID [147 (25.29)] |
| OIL FILTER | LEFT | |
| OIL DRAIN HOSE | RIGHT | |
| RADIATOR DRAIN HOSE | RIGHT | |
| COOLANT RECOVERY BOTTLE | RIGHT | |
| RADIATOR FILL CAP ACCESS | ROOF | |
| AIR CLEANER ELEMENT | RIGHT | |
| MUFFLER | FRONT | |
| BATTERY | EITHER | |
| | RIGHT | |

NOTES:

- MINIMUM RECOMMENDED CONCRETE PAD SIZE: 1184 (47") WIDE X 2718 (107") LONG. REFER TO INSTALLATION MANUAL FOR CONCRETE PAD GUIDELINES.
- ALLOW SUFFICIENT ROOM ON ALL SIDES OF THE GENERATOR FOR MAINTENANCE AND SERVICING. THIS UNIT MUST BE INSTALLED IN ACCORDANCE WITH CURRENT APPLICABLE NFPA 37 AND NFPA 70 STANDARDS AS WELL AS ANY OTHER FEDERAL, STATE, OR LOCAL APPLICABLE CODES.
- CONTROL PANEL, CIRCUIT BREAKER INFORMATION:
 - SEE SPECIFICATION SHEET OR OWNERS MANUAL.
 - ACCESSIBLE THROUGH CUSTOMER ACCESS ASSEMBLY DOOR ON REAR OF GENERATOR.
 - REAR TANK AND REAR ENCLOSURE COVER PANEL TO ACCESS THE STUB-UP AREAS AS FOLLOWS:
 - HIGH VOLTAGE CONNECTION INCLUDING AC LOAD LEAD CONDUIT CONNECTION NEUTRAL CONNECTION, BATTERY CHARGER 120 VOLT AC (0.5 AMP MAX) CONNECTION.
 - LOW VOLTAGE CONNECTIONS INCLUDING TRANSFER SWITCH CONTROL WIRES.
 - ENGINE SERVICE CONNECTIONS.
- EXHAUST OUTLET: 2" O.D.
- BOTTOM OF GENERATOR SET MUST BE ENCLOSED TO PREVENT PEST INTRUSION AND AIR DRAINAGE. THIS IS DONE BY THE REAR ENCLOSURE COVER PANEL PER COOLING AIR FLOW. REFER TO OWNERS MANUAL FOR INSTALLATION INSTRUCTIONS.
- MOUNTING BOLTS OR STUDS TO CONCRETE PAD SHALL BE 5/8-11 GRADE 5 (USE STANDARD SAE TORQUE SPECS)
- LIFT-OFF DOOR PROVIDES ACCESS TO: FUEL FILL, FUEL LEVEL GAUGE, NORMAL VENT, INNER TANK EMERGENCY VENT, OUTER TANK EMERGENCY VENT, BATTERY CHARGER ASSEMBLY, OPTIONAL 5 GALLON SPILL BOX.

REFERENCE OWNERS MANUAL FOR PERIODIC REPLACEMENT PART LISTINGS

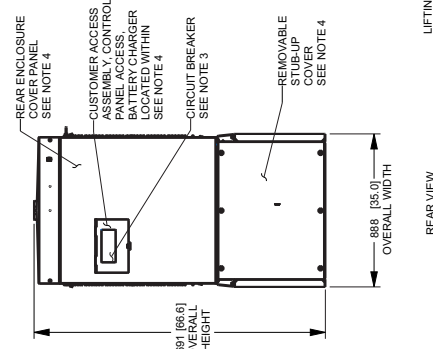
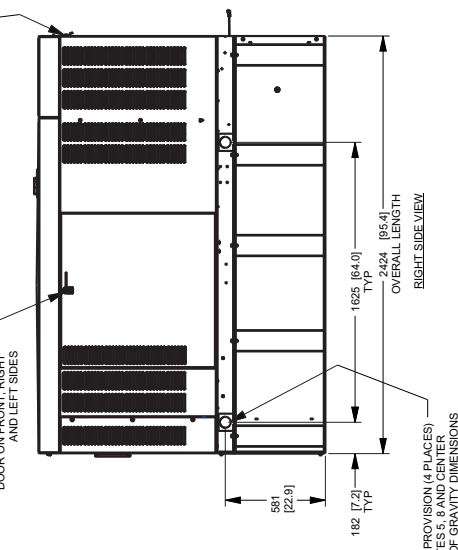
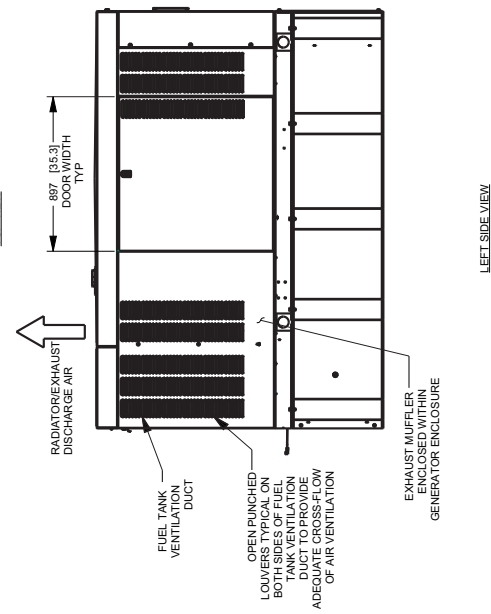
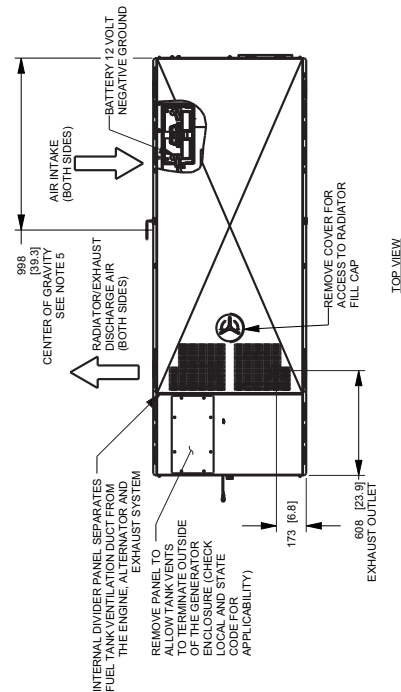

LIFTING PROVISION (4 PLACES) SEE NOTES 5, 8 AND CENTER OF GRAVITY DIMENSIONS

LEFT SIDE VIEW

REAR VIEW

RIGHT SIDE VIEW

TOP VIEW

D3.3L G16 132 Gal Tank (2 of 2)

| FUEL TANK | |
|-----------------|-------------|
| TOTAL CAPACITY | 624 [138.5] |
| USABLE CAPACITY | 500 [132] |

CAPACITY: LITER (GALLONS)
DIMENSIONS: MM (INCH)

THIS TANK IS LISTED TO UL 142 AND ULCS601

*NOTE: STUB-UP AREA FOR HIGH AND LOW VOLTAGE CONNECTIONS, CIRCUIT BREAKER, NEUTRAL AND CUSTOMER CONNECTION OPENING.

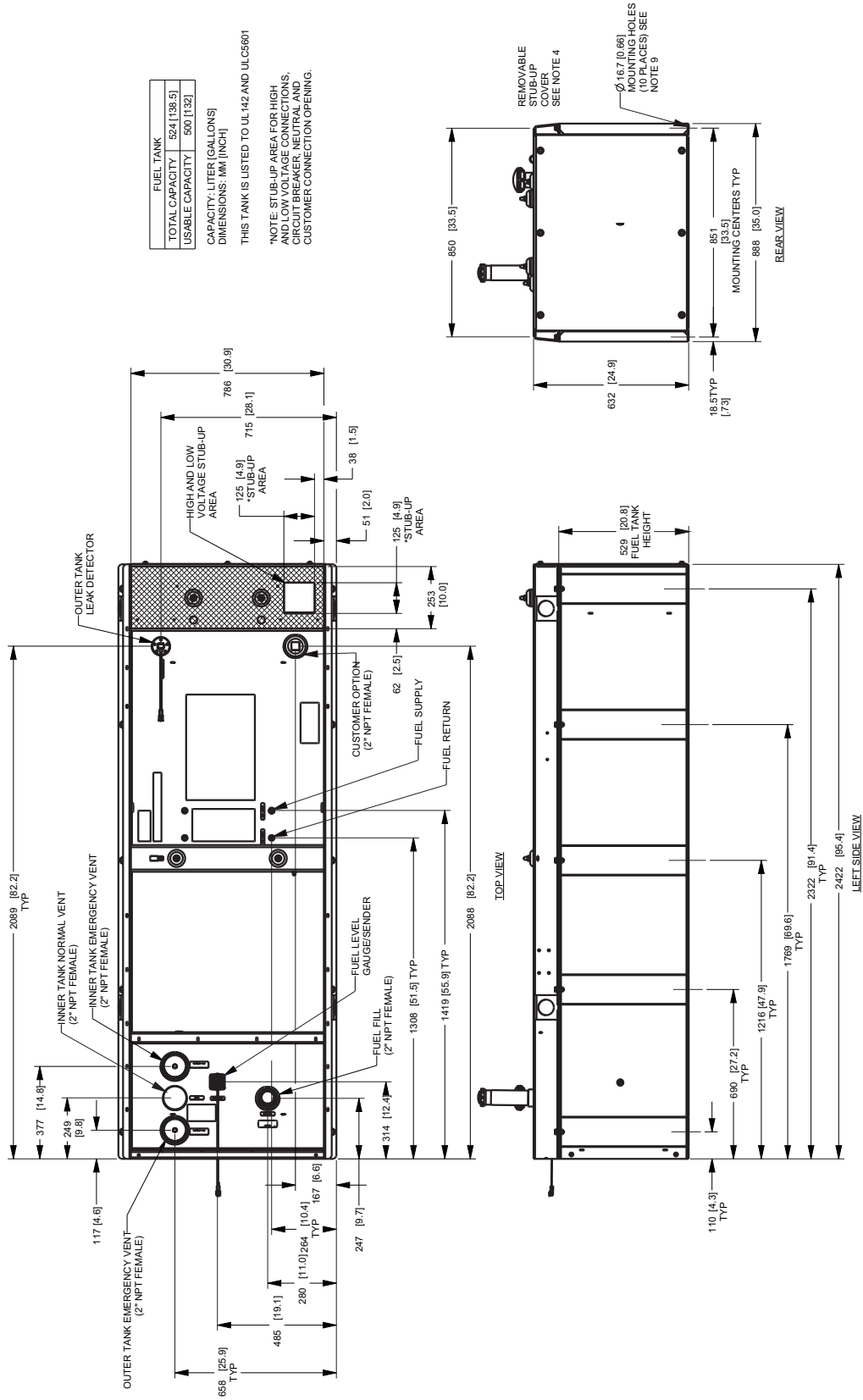

15 • 20 • 30 • 48 • 50 kW

GENERAC®**Available Accessories**

| Model # | Product | Description |
|---|-----------------------------------|---|
| G006478-0 | Harness Adapter Kit | The Harness Adapter Kit is required to make liquid-cooled units compatible with Mobile Link™. |
| G006502-0 | Spill Box | The 5-gallon spill box screws into the existing fuel fill port of the base tank. It captures and contains fuel if over fueling or spilling occurs during the fill process. |
| G006504-0 | 90% Fuel Level Alarm | The 90% fuel level alarm alerts the fuel fill operator when the tank reaches a 90% fill level by sounding an audible alarm and triggering an LED warning light. |
| G006505-0—15 & 20 kW G006506-0—30, 48, & 50 kW | Tank Risers | Tank risers are required in some municipalities to help avoid potential base tank corrosion caused by mounting on rough surfaces. |
| G006507-0 | Fuel Fill Drop Tube | A powder coat painted, steel fuel fill drop tube is required in some municipalities to prevent sparking due to static electricity buildup, which can be caused by the fuel dropping into the tank from the fill area. Using a drop tube also results in submerged filling, which increases the fuel delivery flow rate and reduces vapors, foam and potential tank evaporation. |
| G007660-0—15 & 20 kW G007661-0—30 kW G007662-0—48 & 50 kW | Stainless Steel Fuel Lines | Some municipalities require the use of stainless steel fuel lines instead of the standard hoses provided with the diesel generator products. These stainless steel lines are fire resistant for additional safety. |
| G006510-0 | E-Stop | E-stop allows for immediate fuel shutoff and generator shutdown in the event of an emergency. |
| G006511-0 | Spill Box Drainback Kit | The spill box drainback kit allows fuel that was captured in the 5-gallon spill box to be drained directly back into the fuel tank to avoid vapors. |
| G006588-1 | Vent Extension Support Kit | The vent extension support kit consists of two aluminum plates with the appropriate pipe cutouts to secure the vent extension pipes coming through the top of the generator enclosure. It helps to minimize stress on the NPT fittings integrated on the tank and also helps protect against pests. |
| G006512-0 | Lockable Fuel Cap | The cast iron, lockable fuel cap provides the ability to lock the fuel system to prevent unwanted fuel tampering or fuel siphoning. |
| G007640-0—15 & 20 kW G007641-0—30 kW G007642-0—48 & 50 kW | Maintenance Kits | The Protector Maintenance Kits offer all the hardware necessary to perform complete maintenance on Generac Protector generators. |
| G007650-0—15 & 20 kW G007651-0—30 kW G007652-0—48 & 50 kW | Cold Weather Kits | Recommended for generators installed in regions where the temperature regularly falls below 32 °F (0 °C). The Cold Weather Kits consist of a block heater with all necessary mounting hardware and a battery warmer with a thermostat built into the battery wrap. |
| G005703-0 | Paint Kit | If the generator enclosure is scratched or damaged, it is important to touch up the paint to protect from future corrosion. The paint kit includes the necessary paint to properly maintain or touch up a generator enclosure. |
| G006873-0 | Smart Management Module (50 Amps) | Manage large loads by utilizing up to 8 individual Smart Management modules. These devices are installed directly in line with existing appliance wiring for easy installation. |
| A0000018981 | Ultrasonic Cleaner Solution | An ultra-concentrated anti-corrosive cleaning solution engineered to reach the smallest cavities to clean the toughest contaminants. This water based formula is non-toxic, biodegradable, safe for both metal and plastic surfaces and is superior in rinsability. |
| A0000019001 | All Surface Protectant | All surface protectant for vinyl, rubber, plastics creates a barrier that seals & protects surfaces from water, UV rays while renewing the look of the surface. |

GENERAC®

Generac Power Systems, Inc. • S45 W29290 HWY. 59, Waukesha, WI 53189 • generac.com

©2018 Generac Power Systems, Inc. All rights reserved. All specifications are subject to change without notice. Part No. 10000023912-E 04/16/2020