

# Operator Manual

## Generator Set

with PowerCommand<sup>®</sup> Control PCC 2100

DGBB (Spec K–M)  
DGBC (Spec J–L)  
DGCA (Spec T–V)  
DGCB (Spec T–V)  
DGCG (Spec A–C)  
DGFA (Spec P–S)  
DGFB (Spec P–S)  
DGFC (Spec L–N)  
DGFS (Spec A–C)

**California**

**Proposition 65 Warning**

**Diesel engine exhaust and some of its constituents are known to the State of California to cause cancer, birth defects, and other reproductive harm.**

# Table of Contents

---

SECTION	TITLE	PAGE
	<b>IMPORTANT SAFETY INSTRUCTIONS</b> .....	iii
<b>1</b>	<b>INTRODUCTION</b>	
	General .....	1-1
	How to Obtain Service .....	1-1
<b>2</b>	<b>SPECIFICATIONS</b> .....	2-1
<b>3</b>	<b>CONTROL OPERATION</b>	
	General .....	3-1
	Prestart Checks .....	3-1
	Control Panel Power On/Off Modes .....	3-2
	Battle Short Mode (Optional) .....	3-3
	Front Panel .....	3-5
	Starting .....	3-7
	Stopping .....	3-9
	Menu Display and Buttons .....	3-13
	Main Menu .....	3-15
	Adjusting Default Settings .....	3-17
	System Messages .....	3-17
	Controller Configuration Menu .....	3-18
	Engine Menu .....	3-20
	Alternator Menu .....	3-22
	Adjust Menu .....	3-24
	Faults Menu .....	3-26
	System Menu .....	3-28
	History Menu .....	3-30
	About Menu .....	3-32
	Power Transfer Menu .....	3-34



<b>SECTION</b>	<b>TITLE</b>	<b>PAGE</b>
<b>4</b>	<b>TROUBLESHOOTING</b>	
	General .....	4-1
	Safety Considerations .....	4-1
	Status Indicators .....	4-2
	Line Circuit Breaker (Optional) .....	4-2
	Control and Diagnostics VIA Network or PC (Laptop) .....	4-2
	Fault Codes .....	4-4
	Fault Code Table .....	4-4
	Troubleshooting Table .....	4-6
<b>5</b>	<b>MAINTENANCE</b>	
	General .....	5-1
	Maintenance Schedule .....	5-2
	Generator Set Inspection .....	5-3
	Generator Set Maintenance (Battery Disconnected) .....	5-4
	Lubrication System .....	5-5
	Oil and Filter Change .....	5-6
	Cooling System .....	5-7
	Change Air Cooler System .....	5-7
	Fuel System .....	5-7
	Air Cleaner .....	5-8
	Batteries .....	5-9
<b>6</b>	<b>OPERATING RECOMMENDATIONS</b>	
	No-Load Operation .....	6-1
	Exercise Period .....	6-1
	Low Operating Temperature .....	6-1
	High Operating Temperature .....	6-1



# IMPORTANT SAFETY INSTRUCTIONS

---

**SAVE THESE INSTRUCTIONS** – This manual contains important instructions that should be followed during installation and maintenance of the generator and batteries.

**Before operating the generator set (genset)**, read the Operator's Manual and become familiar with it and the equipment. **Safe and efficient operation can be achieved only if the equipment is properly operated and maintained.** Many accidents are caused by failure to follow fundamental rules and precautions.

The following symbols, found throughout this manual, alert you to potentially dangerous conditions to the operator, service personnel, or the equipment.

**⚠ DANGER** *This symbol warns of immediate hazards which will result in severe personal injury or death.*

**⚠ WARNING** *This symbol refers to a hazard or unsafe practice which can result in severe personal injury or death.*

**⚠ CAUTION** *This symbol refers to a hazard or unsafe practice which can result in personal injury or product or property damage.*

## FUEL AND FUMES ARE FLAMMABLE

Fire, explosion, and personal injury or death can result from improper practices.

- DO NOT fill fuel tanks while engine is running, unless tanks are outside the engine compartment. Fuel contact with hot engine or exhaust is a potential fire hazard.
- DO NOT permit any flame, cigarette, pilot light, spark, arcing equipment, or other ignition source near the generator set or fuel tank.
- Fuel lines must be adequately secured and free of leaks. Fuel connection at the engine should be made with an approved flexible line. Do not use zinc coated or copper fuel lines with diesel fuel.
- Be sure all fuel supplies have a positive shutoff valve.
- Be sure battery area has been well-ventilated prior to servicing near it. Lead-acid batteries emit a highly explosive hydrogen gas that can be ignited by arcing, sparking, smoking, etc.

## EXHAUST GASES ARE DEADLY

- Provide an adequate exhaust system to properly expel discharged gases away from enclosed or sheltered areas and areas where individuals are likely to congregate. Visually and audibly inspect the exhaust daily for leaks per the maintenance schedule. Make sure that exhaust manifolds are secured and not warped. Do not use exhaust gases to heat a compartment.
- Be sure the unit is well ventilated.
- Engine exhaust and some of its constituents are known to the state of California to cause cancer, birth defects, and other reproductive harm.

## MOVING PARTS CAN CAUSE SEVERE PERSONAL INJURY OR DEATH

- Keep your hands, clothing, and jewelry away from moving parts.
- Before starting work on the generator set, disconnect battery charger from its AC source, then disconnect starting batteries, negative (-) cable first. This will prevent accidental starting.
- Make sure that fasteners on the generator set are secure. Tighten supports and clamps, keep guards in position over fans, drive belts, etc.
- Do not wear loose clothing or jewelry in the vicinity of moving parts, or while working on electrical equipment. Loose clothing and jewelry can become caught in moving parts.
- If adjustment must be made while the unit is running, use extreme caution around hot manifolds, moving parts, etc.

## DO NOT OPERATE IN FLAMMABLE AND EXPLOSIVE ENVIRONMENTS

Flammable vapor can cause an engine to overspeed and become difficult to stop, resulting in possible fire, explosion, severe personal injury and death. Do not operate a genset where a flammable vapor environment can be created by fuel spill, leak, etc., unless the genset is equipped with an automatic safety device to block the air intake and stop the engine. The owners and operators of the genset are solely responsible for operating the genset safely. Contact your authorized Cummins Power Generation distributor for more information.

## **ELECTRICAL SHOCK CAN CAUSE SEVERE PERSONAL INJURY OR DEATH**

- Remove electric power before removing protective shields or touching electrical equipment. Use rubber insulative mats placed on dry wood platforms over floors that are metal or concrete when around electrical equipment. Do not wear damp clothing (particularly wet shoes) or allow skin surface to be damp when handling electrical equipment. Do not wear jewelry. Jewelry can short out electrical contacts and cause shock or burning.
- Use extreme caution when working on electrical components. High voltages can cause injury or death. DO NOT tamper with interlocks.
- Follow all applicable state and local electrical codes. Have all electrical installations performed by a qualified licensed electrician. Tag and lock open switches to avoid accidental closure.
- DO NOT CONNECT GENERATOR SET DIRECTLY TO ANY BUILDING ELECTRICAL SYSTEM. Hazardous voltages can flow from the generator set into the utility line. This creates a potential for electrocution or property damage. Connect only through an approved isolation switch or an approved paralleling device.

## **GENERAL SAFETY PRECAUTIONS**

- Coolants under pressure have a higher boiling point than water. DO NOT open a radiator or heat exchanger pressure cap while the engine is running. Allow the generator set to cool and bleed the system pressure first.
- Used engine oils have been identified by some state or federal agencies as causing cancer or reproductive toxicity. When checking or changing engine oil, take care not to ingest, breathe the fumes, or contact used oil.
- Keep multi-class ABC fire extinguishers handy. Class A fires involve ordinary combustible materials such as wood and cloth; Class B fires, combustible and flammable liquid fuels and gaseous fuels; Class C fires, live electrical equipment. (ref. NFPA No. 10).
- Make sure that rags are not left on or near the engine.
- Make sure generator set is mounted in a manner to prevent combustible materials from accumulating under the unit.
- Remove all unnecessary grease and oil from the unit. Accumulated grease and oil can cause overheating and engine damage which present a potential fire hazard.
- Keep the generator set and the surrounding area clean and free from obstructions. Remove any debris from the set and keep the floor clean and dry.
- Do not work on this equipment when mentally or physically fatigued, or after consuming any alcohol or drug that makes the operation of equipment unsafe.
- Substances in exhaust gases have been identified by some state or federal agencies as causing cancer or reproductive toxicity. Take care not to breathe or ingest or come into contact with exhaust gases.
- Do not store any flammable liquids, such as fuel, cleaners, oil, etc., near the generator set. A fire or explosion could result.
- Wear hearing protection when going near an operating generator set.
- To prevent serious burns, avoid contact with hot metal parts such as radiator, turbo charger and exhaust system.

**KEEP THIS MANUAL NEAR THE GENSET FOR EASY REFERENCE**



# 1. Introduction

---

## GENERAL

Each operator should read this manual before operating the generator set (genset) for the first time. A genset must be operated and maintained properly if you are to expect safe and reliable operation. This manual includes a troubleshooting guide and a maintenance schedule.

The engine manual is included with the set. Where there is conflicting information, this manual takes precedence over the engine manual.

**⚠ WARNING** *Improper operation and maintenance can lead to severe personal injury or loss of life and property by fire, electrocution, mechanical breakdown or exhaust gas asphyxiation. Read Important Safety Instructions and precautions in this manual.*

## HOW TO OBTAIN SERVICE

When the generator set requires servicing, contact your nearest Cummins Power Generation distributor. Factory-trained Parts and Service representatives are ready to handle all your service needs.

To contact your local Cummins Power Generation distributor in the United States or Canada, call 1-800-888-6626 (this automated service utilizes touch-tone phones only). By selecting Option 1 (press 1), you will be automatically connected to the distributor nearest you.

If you are unable to contact a distributor using the automated service, consult the Yellow Pages. Typically, our distributors are listed under:

GENERATORS-ELECTRIC or  
ELECTRICAL PRODUCTS

For outside North America, call Cummins Power Generation, 1-763-574-5000, 7:30 AM to 4:00 PM, Central Standard Time, Monday through Friday. Or, send a fax to Cummins Power Generation using the fax number 1-763-528-7229.

When contacting your distributor, always supply the complete Model, Specification, and Serial Number as shown on the generator set nameplate.

## **⚠ WARNING**

**INCORRECT SERVICE OR PARTS REPLACEMENT CAN RESULT IN SEVERE PERSONAL INJURY, DEATH, AND/OR EQUIPMENT DAMAGE. SERVICE PERSONNEL MUST BE TRAINED AND EXPERIENCED TO PERFORM ELECTRICAL AND/OR MECHANICAL SERVICE.**



**THIS PAGE LEFT INTENTIONALLY BLANK**





## 2. Specifications

MODEL	DGBB, DGBC, DGCA, DGCB	DGCG
<b>Engine</b> Cummins Diesel Series	4B3.9	4BA3.9
<b>Generator kW Rating</b>	See Genset Nameplate for rating information	
<b>Electrical System</b> Starting Voltage Battery Group Number CCA (minimum) Cold Soak @ 0°F (-18° C)	12 Volts DC One, 12 Volt 4D  1080	
<b>Cooling System</b> Capacity with Standard Radiator	5.5 Gal (21 L)	4.7 Gal (17.7 L)
<b>Lubricating System</b> Oil Capacity with Filters Oil Type*	12 Qts (11 L)	11.5 Qts (10.9 L)
* Refer to Cummins engine <i>Operation and Maintenance Manual</i> for lubricating oil recommendations/specifications.		

### FUEL CONSUMPTION (STANDBY/FULL LOAD/60HZ)

MODEL	DGBB	DGBC	DGCA	DGCB	DGCG
<b>US gph (L/hr)</b>	2.9 (11)	3.4 (12.9)	4.2 (15.9)	4.7 (17.8)	6.3 (24)

OIL PRESSURE WARNING AND SHUTDOWN LIMITS	
<b>Normal Oil Pressure</b>	<b>40-70 psi (276-483 kPa)</b>
Warning Limit	20 psi (138 kPa)
Shutdown Limit	15 psi (103 kPa)
<b>Idle Oil Pressure</b>	<b>10-30 psi (69-207 kPa)</b>
Warning Limit	12 psi (83 kPa)
Shutdown Limit	8 psi (55 kPa)

MODEL	DGFA	DGFB	DGFC	DGFS
<b>Engine</b> Cummins Diesel Series	6CTA8.3	6CTA8.3	6CTAA8.3	
<b>Generator kW Rating</b>	See Genset Nameplate for rating information			
<b>Electrical System</b> Starting Voltage Battery Group Number CCA (minimum) Cold Soak @ 0°F (-18° C)	12 Volts DC One, 12 Volt 4D  1080			
<b>Cooling System</b> Capacity with Standard Radiator	7.5 Gal (28 L)	7.5 Gal (28 L)	6.8 Gal (26 L)	7.8 Gal (29.6 L)
<b>Lubricating System</b> Oil Capacity with Filters Oil Type*	25.2 Qts (24 L)			
* Refer to Cummins engine <i>Operation and Maintenance Manual</i> for lubricating oil recommendations/specifications.				

**FUEL CONSUMPTION (STANDBY/FULL LOAD/60HZ)**

MODEL	DGFA	DGFB	DGFC	DGFS
<b>US gph (L/hr)</b>	11.3 (42.8)	13.2 (50)	14.4 (54.6)	18.1 (68.6)



# 3. Control Operation

---

## GENERAL

The following describes the function and operation of the PowerCommand® 2100 Control (PCC). All indicators, control switches/buttons and digital display are located on the face of the control panel as illustrated in Figure 3-1.

This section covers prestart checks, starting and stopping and operating the generator set. Each operator should read through this entire section before they attempt to start the generator set. It is essential that the operator be completely familiar with the generator set and the PCC control. Refer to *Section 6* for operating recommendations.

Before starting, be sure the following checks have been made and the unit is ready for operation.

## PRESTART CHECKS

### Lubrication

Check the engine oil level. Keep the oil level near as possible to the dipstick high mark without overfilling.

### Coolant

Check the engine coolant level. Refer to “Cooling Systems” in the Maintenance section of this manual for proper procedure.

### Fuel

Make sure the fuel tanks have sufficient fuel and that fuel system is primed. Check to make sure there are no leaks and that all fittings are tight.

### Ventilation

Make sure the generator set cooling inlet/outlet and exhaust ventilation openings are clear (not blocked) and operational.

Remove all loose debris from surrounding area of generator set. Air flow from the radiator fan can blow loose items around and into ventilation openings.

### Exhaust

Check to make sure entire exhaust system is tight, that no combustible materials are near system, and gases are discharged away from building openings.

## EXHAUST GAS IS DEADLY!

***Exhaust gases contain carbon monoxide, an odorless and colorless gas. Carbon monoxide is poisonous and can cause unconsciousness and death. Symptoms of carbon monoxide poisoning can include:***

- ***Dizziness***
- ***Nausea***
- ***Headache***
- ***Weakness and Sleepiness***
- ***Throbbing in Temples***
- ***Muscular Twitching***
- ***Vomiting***
- ***Inability to Think Coherently***

***IF YOU OR ANYONE ELSE EXPERIENCE ANY OF THESE SYMPTOMS, GET OUT INTO THE FRESH AIR IMMEDIATELY. If symptoms persist, seek medical attention. Shut down the unit and do not operate until it has been inspected and repaired.***

***Protection against carbon monoxide inhalation includes proper installation and regular, frequent visual and audible inspections of the complete exhaust system.***

## CONTROL PANEL POWER ON/OFF MODES

The power on/off modes of the control panel and operating software are Power On, Screen Saver and Sleep/Awake.

**Power On Mode:** In this mode, power is continuously supplied to the control panel. The control's operating software and control panel LEDs/digital display will remain active until the Screen Saver mode is activated.

**Screen Saver Mode:** Power to the digital display is removed after 30 minutes (generator set not running or running). The 30 minute timer resets and begins after each control panel action (any button or switch selection) or signal received by the operating software. All LEDs on the control panel operate normally during Screen Saver mode, indicating that the operating software is active (Awake mode).

When a "Warning" signal is sensed by the PCC (for example, low coolant temp), the control displays the warning message.

**Sleep/Awake Mode:** In the Sleep mode, the control's operating software is inactive and the LEDs and the digital display on the control panel are all off. Sleep mode is a feature used to reduce battery power consumption when the control is not being

used and the O/Manual/Auto switch is in the O position.

When all conditions are met (i.e., no unacknowledged faults and O/Manual/Auto switch is in the O position) the Sleep mode is activated.

The operating software is initialized and the digital display and control panel LEDs are turned on in response to moving/pressing the following control panel switch/buttons:

- Off/Manual/Auto switch
- Emergency Stop button
- Fault Acknowledge/Reset button
- Panel Lamp/Lamp Test button

To activate the control and view the menu display without starting the generator set, press Fault Acknowledge or Panel Lamp button or move mode switch from O to Manual.

The InPower service tool is required to enable or disable the Sleep mode. When shipped from the factory, Sleep mode is disabled. When disabled, the operating software will always remain active (Awake mode). If network and/or power transfer control (PTC) feature is installed, the sleep mode is not available.

**The InPower service tool is required to select the desired mode. Contact an authorized service center for assistance.**



## BATTLE SHORT MODE (OPTIONAL)

The purpose of Battle Short mode is to satisfy local code requirements where necessary.

The Battle Short mode prevents the genset from being shutdown by all but a select few critical shutdown faults. **All shutdown faults, including those overridden by Battle Short, must be acted upon immediately to ensure the safety and well being of the operator and the genset.**

**⚠WARNING** *Use of this feature can cause a fire or electrical hazard, resulting in severe personal injury or death and/or property and equipment damage. Operation of the genset must be supervised during Battle Short mode operation.*

This feature should only be used during supervised, temporary operation of the genset. The faults that are overridden during Battle Short mode consist of faults that can affect genset performance or cause permanent **engine, alternator, or connected equipment damage. Operation may void generator set warranty if damage occurs that relates to fault condition.**

When Battle Short mode is enabled, the **Warning** status indicator is lit, along with displayed fault code **1131 – Battle Short Active**.

With Battle Short mode enabled and a critical shutdown fault occurs, the shutdown fault is announced but the genset does not shut down, and fault code **1416 – Fail To Shut Down** is displayed. The Fault Acknowledgement/Reset button will clear the fault message, but will remain in the Fault/History file with an asterisk sign (\* equals active fault) as long as Battle Short mode is enabled.

Battle Short is suspended and a shutdown occurs immediately if:

- Any of the following critical shutdown faults occurs:
  - Overspeed – Fault code 234
  - Emergency Stop – Fault code 1433
  - Remote Emergency Stop – Fault code 1434
  - Speed Signal Lost – Fault code 121
  - Excitation Fault – Fault code 2335
- Moving the customer installed Battle Short switch to OFF with an active but overridden shutdown fault or a shutdown fault that was overridden at any time. (Fault code **1123 – Shutdown After Battle Short** will be displayed for this type of shutdown.)

A qualified service personnel is required to enable this feature. When shipped from the factory, this feature is disabled. An external switch (customer supplied), which connects to one of the four Customer Inputs, is used by the operator to switch the genset in/out of Battle Short mode.

**The software for the Battle Short feature must be installed at the factory or ordered and installed by an authorized service representative. When installed, the InPower service tool is required to enable the Battle Short mode feature and to configure a Customer Input for external switch control (on/off) of the Battle Short mode. Contact an authorized service center for assistance.**



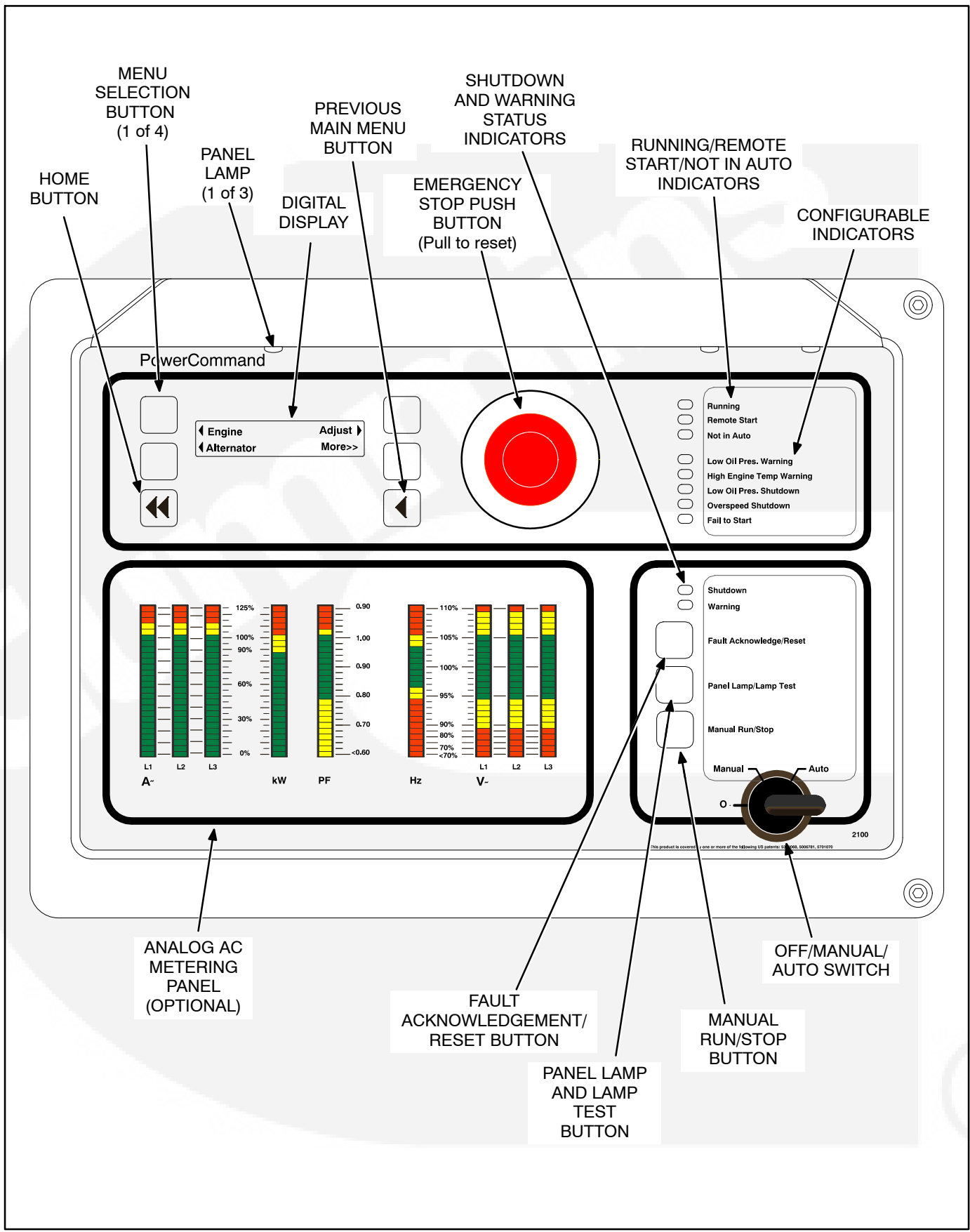

FIGURE 3-1. FRONT PANEL

## FRONT PANEL

Figure 3-1 shows the features of the front panel.

**Digital Display:** This two-line, 20-character per line alphanumeric display is used to view menus of the menu-driven operating system. Refer to the menu trees later in this section. The display is also used to show warning and shutdown messages.

**Display Menu Selection Buttons:** Four momentary buttons—two on each side of the digital display window—are used to step through the various menu options and to adjust generator set parameters. A green triangle (◀ or ▶), arrow (↑, ↓, ←, or →), >>, or plus/minus sign (+ or -) in the digital display adjacent to the button is shown when the button can be used (button is “active”). Refer to *Menu Display And Buttons* later in this section.

**Home Button:** Press this button (◀◀) to view the Home Menu. Refer to the menu trees later in this section.

**Previous Main Menu Button:** Press this button (◀) to view the previous Main Menu. All main menus include both types of green triangles (◀ and ▶). Refer to the menu trees later in this section.

**NOTE:** The up and down arrows (↑ and ↓) are used to navigate between submenus.

**Emergency Stop Button:** Push this button in for emergency shutdown of the generator set. This will stop the generator set immediately and prevent starting of the generator set from any location (local and remote).

To reset:

1. Pull the button and allow it to pop out.
2. Turn the O/Manual/Auto switch to O (Off).
3. Press the front panel Fault Acknowledge/Reset button.
4. Return O/Manual/Auto switch to desired position.

**Emergency Stop shutdown can be reset only at the PCC front panel.**

**Running Indicator:** This green lamp is lit whenever the generator set is running.

**Remote Start Indicator:** This green lamp is lit whenever the control is receiving a remote start signal.

**Not in Auto Indicator:** This red lamp flashes continuously when the O/Manual/Auto switch is not in the Auto position.

**Analog AC Metering Panel (Optional):** This panel simultaneously displays (in percent of genset rated output):

- 3-phase line-to-line AC current (A~) (L1, L2 and L3); Single phase line-to-line (L1 and L2)
- Kilowatts (kW)
- Generator output frequency in hertz (Hz)
- 3-phase line-to-line AC volts (V~) (L1, L2 and L3); Single phase line-to-neutral (L1)
- Power Factor (PF) (shown in 0.2 increments)

**Shutdown Status Indicator:** This red lamp is lit whenever the control detects a shutdown condition. The generator set cannot be started when this lamp is on. After the condition is corrected, shutdown indicators can be reset by turning the O/Manual/Auto switch to the O position and pressing the Fault Acknowledge/Reset button.

**Warning Status Indicator:** This yellow lamp is lit whenever the control detects a warning condition. After the condition is corrected, warning indicators can be reset by pressing the Fault Acknowledge/Reset button. (Majority of faults can be reset without stopping the generator set.) In auto mode, warning indicators can also be reset by cycling the remote reset input after the condition is corrected.

**Some warnings remain active after the condition is corrected and the control reset button is pressed. This will require the genset to be shutdown to reset the warning indicator.**

**Fault Acknowledge/Reset Button:** Press this button to acknowledge warning and shutdown messages after the fault has been corrected. Pressing this button clears the fault from the current fault list.

To acknowledge a Warning message, the O/Manual/Auto switch can be in any position. (It is not necessary to stop the generator set to acknowledge an inactive Warning condition.) To acknowledge a shutdown message with this button, the O/Manual/Auto switch must be in the O position.

**Panel Lamp and Lamp Test Button:** Press this button to turn the control panel lamps on or off. The lights will shut off after about ten minutes. Press and hold this button to test all front panel LEDs and meters. The meters will light one bar at a time. (Test can be enabled during genset operation.)

**Manual Run/Stop Button:** This button starts and stops the generator set locally and will bypass Time Delay to Start and Stop sequences. The O/Manual/Auto switch must be in the Manual position to enable this button.

**O/Manual/Auto Switch:** The Manual position enables the use of the Manual Run/Stop button.

The Auto position enables start/stop control of the engine from a remote location. (It disables the use of the Manual Run/Stop button.)

The O (Off) position prevents the starting of the generator set (local or remote). If the switch is set to O during generator set operation, the engine will immediately shut down (cool-down timers are bypassed). This hot shutdown should be avoided, if possible, to help prolong the life of the generator set.

## Configurable Indicators

The following configurable indicators (default values shown) can be changed with the InPower service tool. The configurable items are: change generator event and LED color (green, yellow or red), and enable/disable indicator.

**The InPower service tool is required to select the desired settings. Contact an authorized service center for assistance.**

**Low Oil Pressure Warning Indicator:** This yellow lamp indicates the oil pressure is lower than the normal range of operation.

**High Engine Temperature Warning Indicator:** This yellow lamp indicates the engine temperature is higher than the normal range of operation.

**Low Oil Pressure Shutdown Indicator:** This red lamp indicates the engine has shut down because of low oil pressure.

**Overspeed Shutdown Indicator:** This red lamp indicates the engine has shut down because of excessive speed.

**Fail to Start Indicator:** This red lamp indicates the engine failed to start.





## STARTING

The following headings cover the systems used to start the generator set. Figures 3-2, 3-3 and 3-4 provide a flow chart for all start/run/stop sequences.

Before starting the generator set, make sure that exhaust and fuel fittings are tight and properly positioned and that proper maintenance has been performed. See *Prestart Checks* in this section.

**With the optional Power Transfer Control (PTC) module installed, the function and sequence of operation of the Start command can differ and is noted as “PTC” in the following paragraphs. Refer to the *Power Transfer Menu* in this section, which describes the operation of the PTC feature.**

### Starting at the Control Panel (Manual Mode)

Turn the O/Manual/Auto switch to the Manual position and press the Manual Run/Stop button. This will activate the engine control system and the starting system. The starter will begin cranking and, after a few seconds, the engine will start and the starter will disconnect.

**The InPower service tool is required to enable/disable the warm-up at idle feature and to adjust the time-out. When shipped from the factory, this feature is disabled.**

When the switch is in the Manual position, the control will complete the warm-up at idle feature if enabled. When the coolant reaches operating temperature or the warm-up time at idle time delay (0–300 seconds) is reached, whichever occurs first, the generator set will ramp to the rated speed and voltage.

**When the switch is in the Manual position, the generator set can be operated in the idle mode (used for maintenance, troubleshooting, etc.). Refer to Adjust menu (Figure 3-11) to enable/disable the idle feature.**

If the engine does not start, the starter will disengage after a specified period of time and the control will indicate an overcrank shutdown.

The generator can be configured for a number of starting cycles (1–7) with generator set times for crank and rest periods for all starting modes (manual/remote). The default setting is for 3 start cycles, composed of 15 seconds of cranking and 15 seconds of rest.

**To change the cycle number, and the crank and rest times, contact an authorized service center for assistance.**

To clear a Fail to Start shutdown, place the O/Manual/Auto switch in the O position and press the Fault Acknowledge/Reset button. Before attempting to restart, wait two minutes for the starter motor to cool and then repeat the starting procedure. If the engine does not run after a second attempt, refer to the *Troubleshooting* section.

### Starting from a Remote Location (PTC or Remote Start Signal) (Auto Mode)

Place the O/Manual/Auto switch in the Auto position. This allows the generator set to be started from a remote switch or device (e.g., transfer switch or optional PTC module).

**PTC – If a switch is connected to the remote start input of the control and the PTC module is installed, this switch will function as a Test switch. The PTC Test sequence is shown in Figure 3-4.**

In response to the Remote Start or the control detects the loss of S1 voltage (PTC option installed), the control lights the Remote Start indicator and initiates the starting sequence as shown in Figure 3-3.

When the switch is in the Auto position, the control will complete the Time Delay To Start function.

**Refer to the Adjust submenu in this section to enable and change the time delay start/stop settings.**

## Cold Starting with Loads

In accordance with NFPA 110, Cummins Power Generation recommends installing diesel standby generator sets (life safety systems) equipped with engine jacket water coolant heaters in locations where the minimum ambient temperature is above 40°F (4°C). NFPA also requires that the engine be heated as necessary to maintain the water jacket temperature determined by the manufacturer for cold start and load acceptance for the type of system. Although most Cummins Power Generation generator sets will start in temperatures down to -25°F (-32°C) when equipped with engine jacket water coolant heaters, it might take more than 10 seconds to warm the engine before a load can be

applied when ambient temperatures are below 40°F (4°C).

The **Engine Cold (Code 1435)** message, is provided to meet the requirements of NFPA 110. The engine cold sensing logic initiates a warning when the engine jacket water coolant temperature falls below 70°F (21°C). In applications where the ambient temperature falls below 40°F (4°C), a cold engine may be indicated even though the coolant heaters are connected and operating correctly. Under these conditions, although the generator set may start, it may not be able to accept load within 10 seconds. When this condition occurs, check the coolant heaters for proper operation. If the coolant heaters are operating properly, other precautions may be necessary to warm the engine before applying a load.



## STOPPING

### Before Stopping

Run the generator set at no load for three to five minutes before stopping. This allows the lubricating oil and engine coolant to carry heat away from the combustion chamber and bearings.

### Emergency Stop

The emergency stop button is located near the center of the upper part of the control panel (Figure 3-1). Push the button in for an emergency stop. The red Shutdown status LED is lit and the emergency stop message is displayed.

To reset:

1. Pull the emergency stop button out.
2. Turn the O/Manual/Auto switch to O.
3. Press the front panel Fault Acknowledge/Reset button.
4. Return O/Manual/Auto switch to desired position.

**Emergency Stop shutdown status can be reset only at the operator control panel.**

### Stopping at Control Panel (Manual Mode)

If the generator set was started at the control panel (O/Manual/Auto switch in the Manual position), pressing the Manual Run/Stop button causes the

generator set to complete its normal (Local Start) shutdown sequence (Figure 3-2).

The generator set stops after the cool-down at idle timer (0 to 30 minutes) has timed out.

**The InPower service tool is required to enable/disable the Cool-down At Idle feature. Contact an authorized service center for assistance.**

Turning the O/Manual/Auto switch to the O position causes an immediate engine shutdown (bypasses Cool-down At Idle). If possible, this hot shutdown should be avoided to help prolong the reliability of the engine.

### Stopping from Remote Location (PTC or Remote Stop Signal) (Auto Mode)

If the control receives a remote stop signal or the control detects the return of S1 voltage (PTC option installed), the generator set completes its normal shutdown sequence (Figure 3-3). (The remote stop signal is actually the removal of the remote start signal to the control.)

The generator set stops after completing the Time Delay To Stop (0 to 600 seconds) and the cool-down at idle (0-30 minutes).

**Refer to the Adjust submenu in this section to enable and change the Time Delay To Stop setting. The InPower service tool is required to enable/disable the Cool-down At Idle feature. Contact an authorized service center for assistance.**



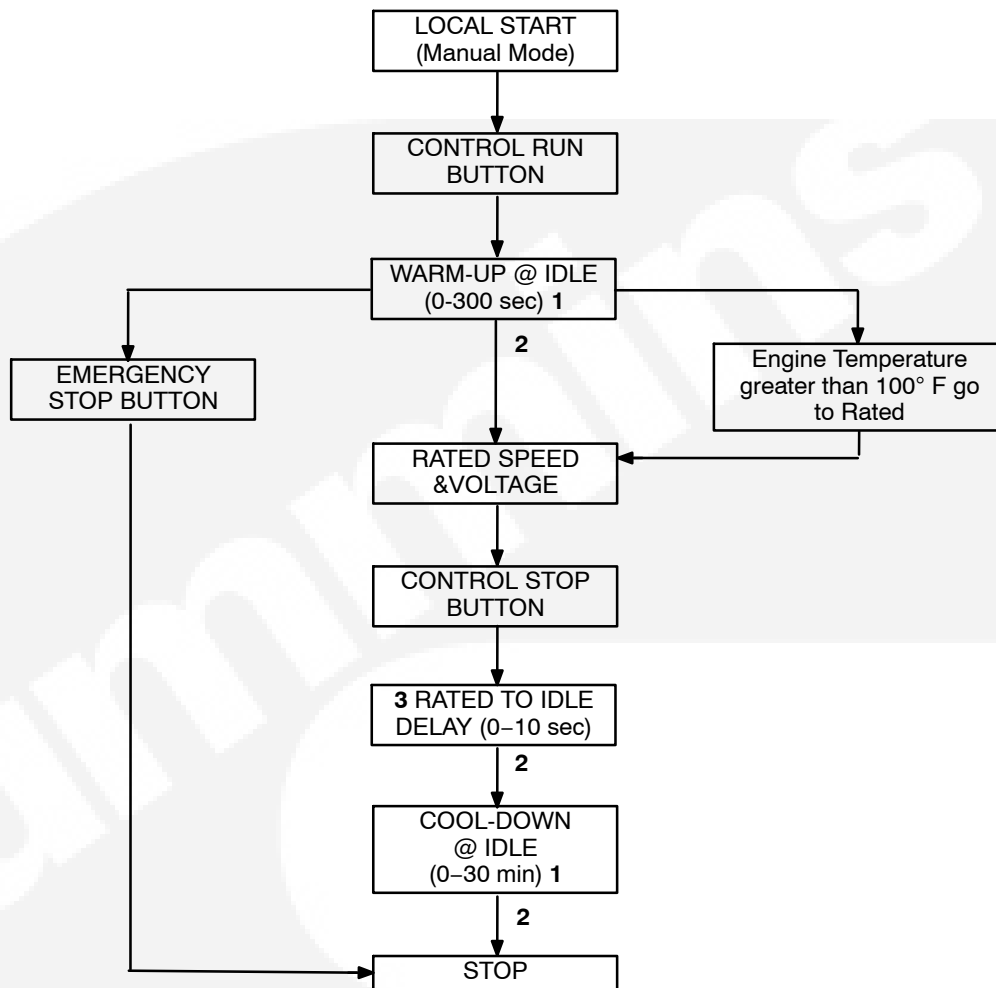

**NOTES:**

1. Warm-up/cool-down idle adjusted time-out with InPower.
2. Timer expires.
- 3, Beginning Version 2.303

**FIGURE 3-2. STARTING AT THE CONTROL PANEL (MANUAL MODE)**

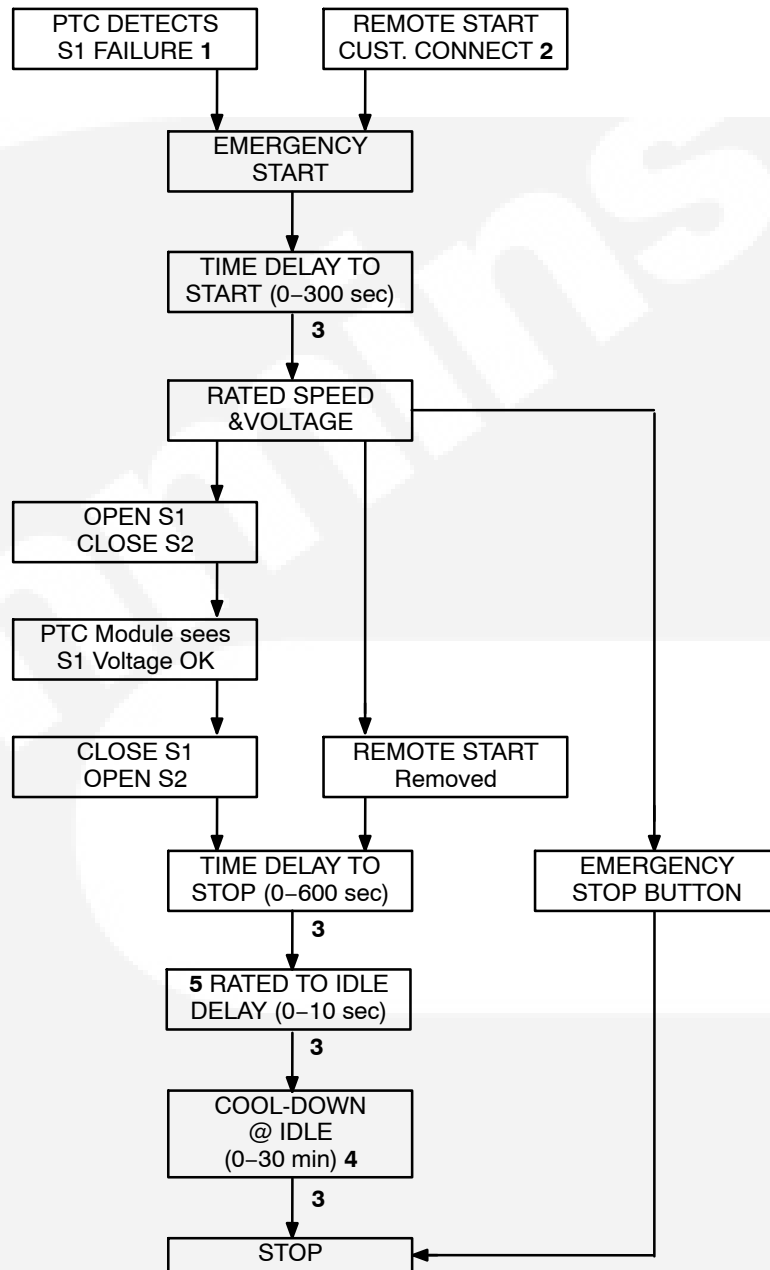

**NOTES:**

1. PTC feature installed.
2. PTC feature not installed (input from transfer switch, remote start switch, etc).
3. Timer expires.
4. Cool-down adjusted time-out with InPower.
5. Beginning Version 2.303

**FIGURE 3-3. STARTING WITH CONTROL IN AUTO MODE (PTC OR REMOTE START SIGNAL)**

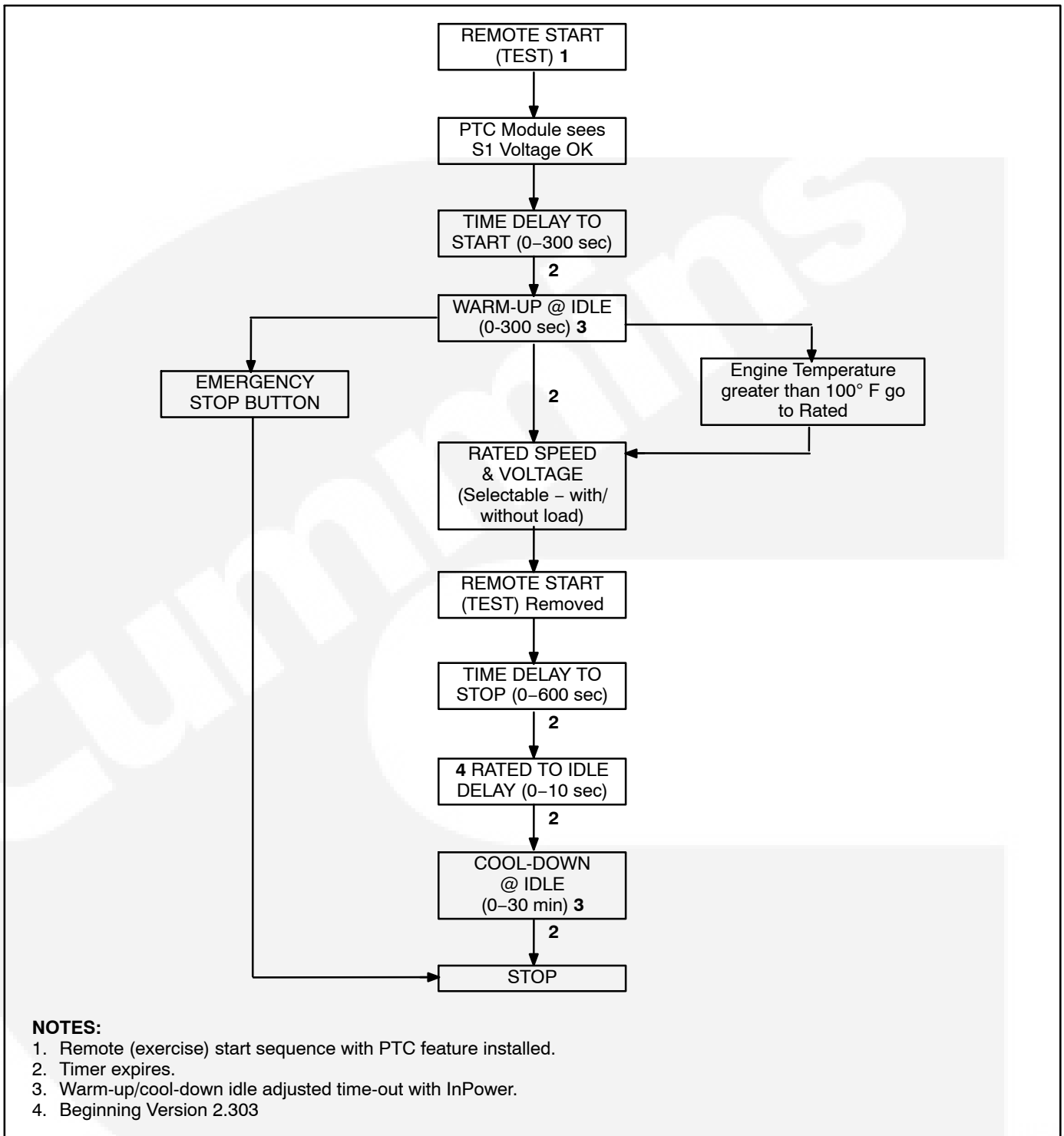

**FIGURE 3-4. PTC FEATURE REMOTE START TEST/EXERCISE SWITCH (IN AUTO MODE)**

## MENU DISPLAY AND BUTTONS

Figure 3-5 shows the digital display and the menu selection buttons.

**Digital Display:** The two-line, 20 characters per line, digital display is used to view the menus of the menu-driven operating system. Refer to the menu trees later in this section. The display is also used to show fault messages.

**Display Menu Selection Buttons:** Four momentary buttons—two on each side of the digital display window—are used to step through the various menu options and to adjust generator set parameters. The button is active when a symbol adjacent to the button is displayed. The displayed symbol indicates the function of the button.

- In the digital display for main menus (Figure 3-6), the ◀ and ▶ symbols indicate that pressing the adjacent button causes the operating program to go to the selected submenu (e.g., Engine Menu in Figure 3-9).
- In the digital display, the More>> symbol indicates that pressing the adjacent button causes the operating program to go to the next main menu, as shown in Figure 3-6.
- In the digital display, the ↓ or ↑ symbols indicate that pressing the adjacent button causes the operating program to go to the next or previous submenu, as shown in the menu diagrams. Only the ↓ symbol is displayed in the first submenu. Only the ↑ is displayed in the last submenu. Both symbols are displayed in the rest of the submenus.

- In the digital display, the plus or minus symbols (+ or -) indicate that pressing the adjacent button can be used to change a parameter or value shown on the display.

When there is a choice of two parameters, one parameter is associated with the + symbol and the other is associated with the - symbol.

When changing values, pressing the button adjacent to the + symbol increase the value and pressing the button adjacent to the - symbol decreases the value. Only one numeric character of a field can be changed at a time.

- In the digital display, the → or ← symbol indicates that pressing the adjacent button causes the operating program to move the cursor to the next numeric character. The selected numeric character can then be changed by pressing the buttons adjacent to the + and - symbols. Only the → symbol is displayed when the cursor is on the first character of a field that can be changed. Only the ← is displayed when the cursor is on the last character. Both symbols are displayed when the cursor is on any other character.
- After adjusting values/parameters, pressing the ▶ symbol results in the changes being saved. **If the Home button or Previous Main Menu button is pressed before pressing the ▶ symbol, the changes are not saved.**

**Home Button:** Pressing this button causes the operating system to show Main Menu 1 (Figure 3-6) in the digital display.

**Previous Main Menu Button:** Pressing this button causes the operating system to show the previous Main Menu in the digital display. All main menus include both types of green triangles (◀ and ▶).

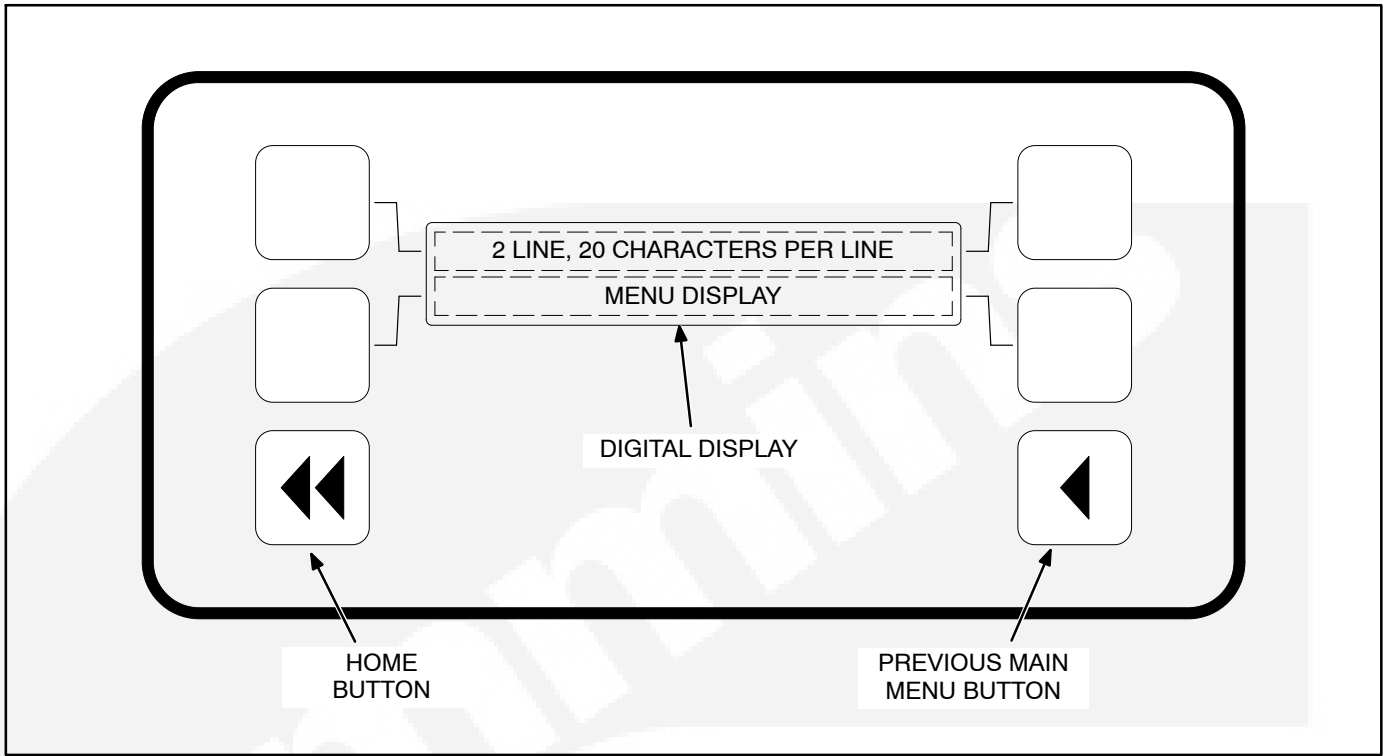

**FIGURE 3-5. DIGITAL DISPLAY AND MENU SELECTION BUTTONS**





## MAIN MENUS

Figure 3-6 shows the three major main menus available to the user. Figure 3-6 also includes references to pages in this section where you can find additional information on submenus. When viewing a submenu, you can press the previous main menu button at any time to view its main menu.

As shown in the illustration, each main menu can branch into one of four directions. Press the button next to "More>>" in the display to view the next Main menu. Main Menu 1 is redisplayed when you press the button next to "More>>" in the Main Menu 3 display.

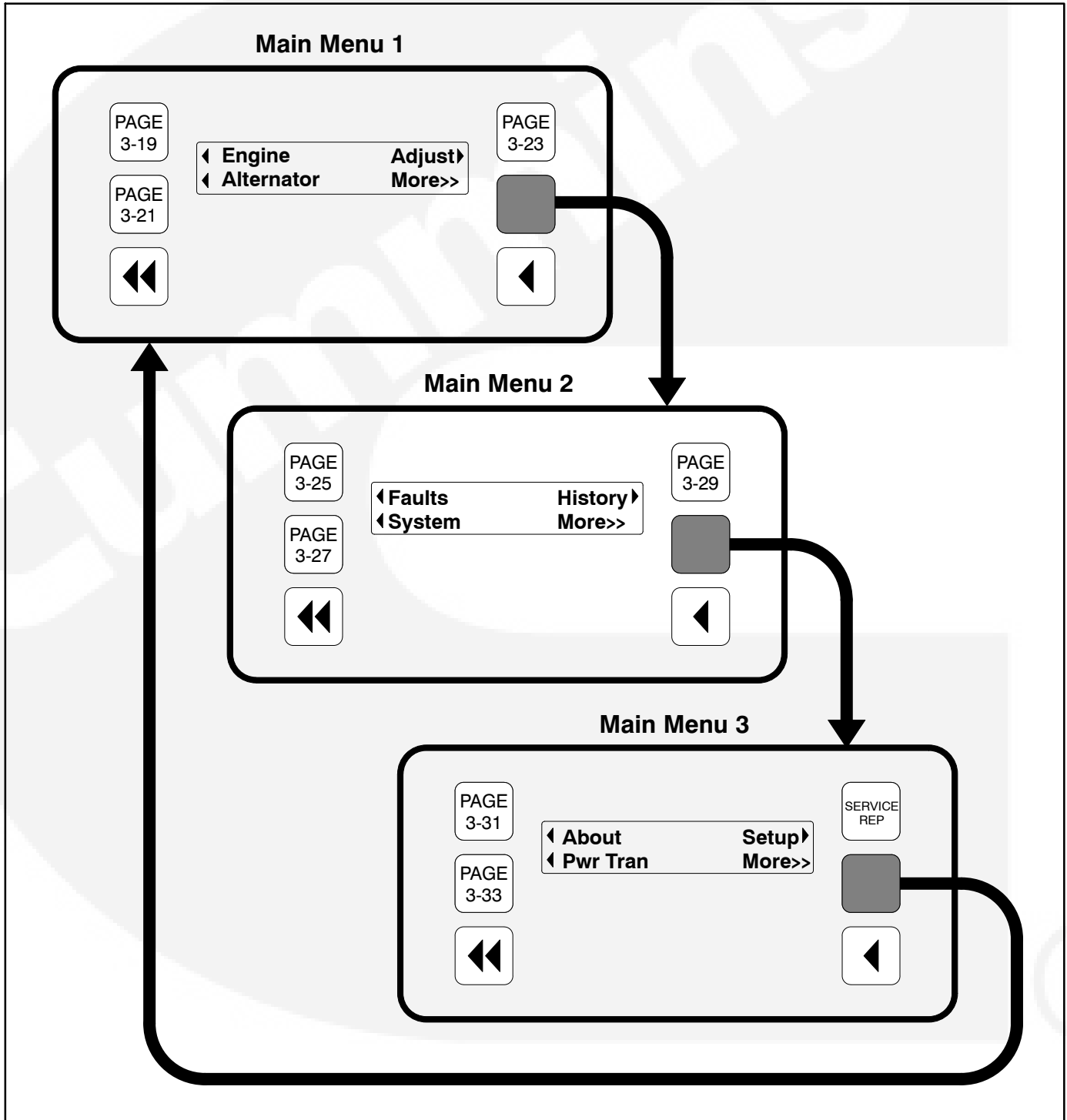

FIGURE 3-6. MAIN MENUS

## Main Menu 1

Main Menu 1 is also the Home menu. When viewing any of the other main menus or any submenu, you can press the home button to view this menu.

To display engine parameters, such as coolant temperature, oil pressure, oil temperature, etc., press the button next to the word “Engine” in the display. Turn to the Engine menu diagram on page 3-19.

To display alternator parameters, such as line-to-line voltage, line-to-neutral voltage, amperage, frequency, etc., press the button next to the word “Alternator” in the display. Turn to the Alternator menu diagram on page 3-21.

To adjust generator parameters, such as idle start, voltage, frequency, start delay, and stop delay, press the button next to the word “Adjust” in the display. Turn to the Adjust menu diagram on page 3-23.

To view one of the other main menus, press the button next to “More>>” in the display.

## Main Menu 2

To display system faults, press the button next to the word “Faults” in the display. Up to 20 of the most recent/current faults can be displayed. Turn to the Faults menu diagram on page 3-25.

To view network system parameters, such as on the automatic transfer switch (ATS), Master, or Genset

system, press the button next to the word “System” in the display. Turn to the System menu diagram on page 3-27.

To display historical engine parameters such as number of starts, engine hours, control hours, kilowatt hours, and genset duty cycle, press the button next to the word “History” in the display. Turn to the History menu diagram on page 3-29.

To view one of the other main menus, press the button next to “More>>” in the display.

## Main Menu 3

To view parameters on the generator, such as model, standby rating, and software version, press the button next to the word “About” in the display. Turn to the About menu diagram on page 3-31.

To view power transfer parameters, such as source power, frequency, generator, utility, and active transfer timer, press the button next to the word “Pwr Tran” in the display. Turn to the Power Transfer Menu on page 3-33.

Main Menu 3 also includes a link to the Setup menu. These menus can be viewed but changes to these menus are restricted to service personnel with the appropriate access code.

To view one of the other main menus, press the button next to “More>>” in the display.



## ADJUSTING DEFAULT SETTINGS

The Controller Configuration Menu can be used to adjust the following default settings:

- Language – Select from available loaded languages
- Temperature Units – Fahrenheit or Centigrade
- Fluid Pressure Units – kPA or PSI

For more information on adjusting these settings, turn to the Controller Configuration menu diagram on page 3-19.

## SYSTEM MESSAGES

A system message pop-up screen is displayed when the event it is displaying becomes active. These pop-up screens remain displayed until preempted by another pop-up screen or until any display button is pressed. Once a button is pressed, the previous menu is redisplayed. To return to an active pop-up screen from the previous menu, select the following menu:

- *Engine* to redisplay Time Delay Idle
- *Faults* to redisplay Faults
- *Power Transfer* to redisplay PTC Timer

Pop-up screens are displayed for the following:

- Faults
- Power Transfer Control timer
- Time Delay – Start, Stop, and Idle

An example of a Time Delay Idle pop-up screen is shown in Figure 3-7. A countdown, in seconds, is included in the display.

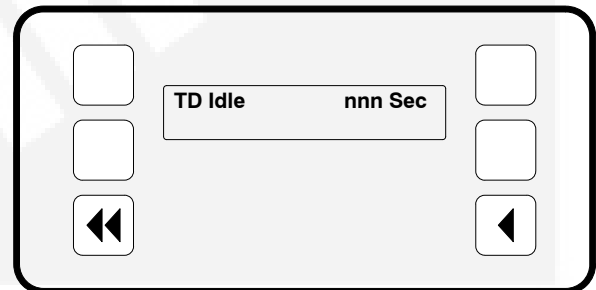

FIGURE 3-7. TIME DELAY IDLE POP-UP SCREEN

## CONTROLLER CONFIGURATION MENU

Figure 3-8 shows a block representation of the Controller Configuration menus. These menus are used to change the default language, temperature units, and pressure units to be displayed in menus.

To view the first Controller Configuration menu, make sure Main Menu 1 is displayed and simultaneously press the Home Menu and Previous Main Menu buttons.

As shown in the diagram, the Controller Configuration menu has three submenus.

Press the buttons next to the ↓ and ↑ symbols in the digital display to navigate between the menus.

Press the button next to the ▶ symbol in the display until the + and – symbols are displayed.

Press the button next to the + or – symbol to select the desired option.

After selecting option, pressing the ▶ symbol results in the changes being saved. If the Home button or Previous Main Menu button is pressed before pressing the ▶ symbol, the changes are not saved.

**Language Selected submenu:** Used to select desired language (default = English).

**Temperature Units submenu:** Used to select Fahrenheit or Centigrade for temperature readings.

**Fluid Pressure Units submenu:** Used to select PSI or kPA for pressure readings.



# CONTROLLER CONFIGURATION MENU

## Main Menu 1

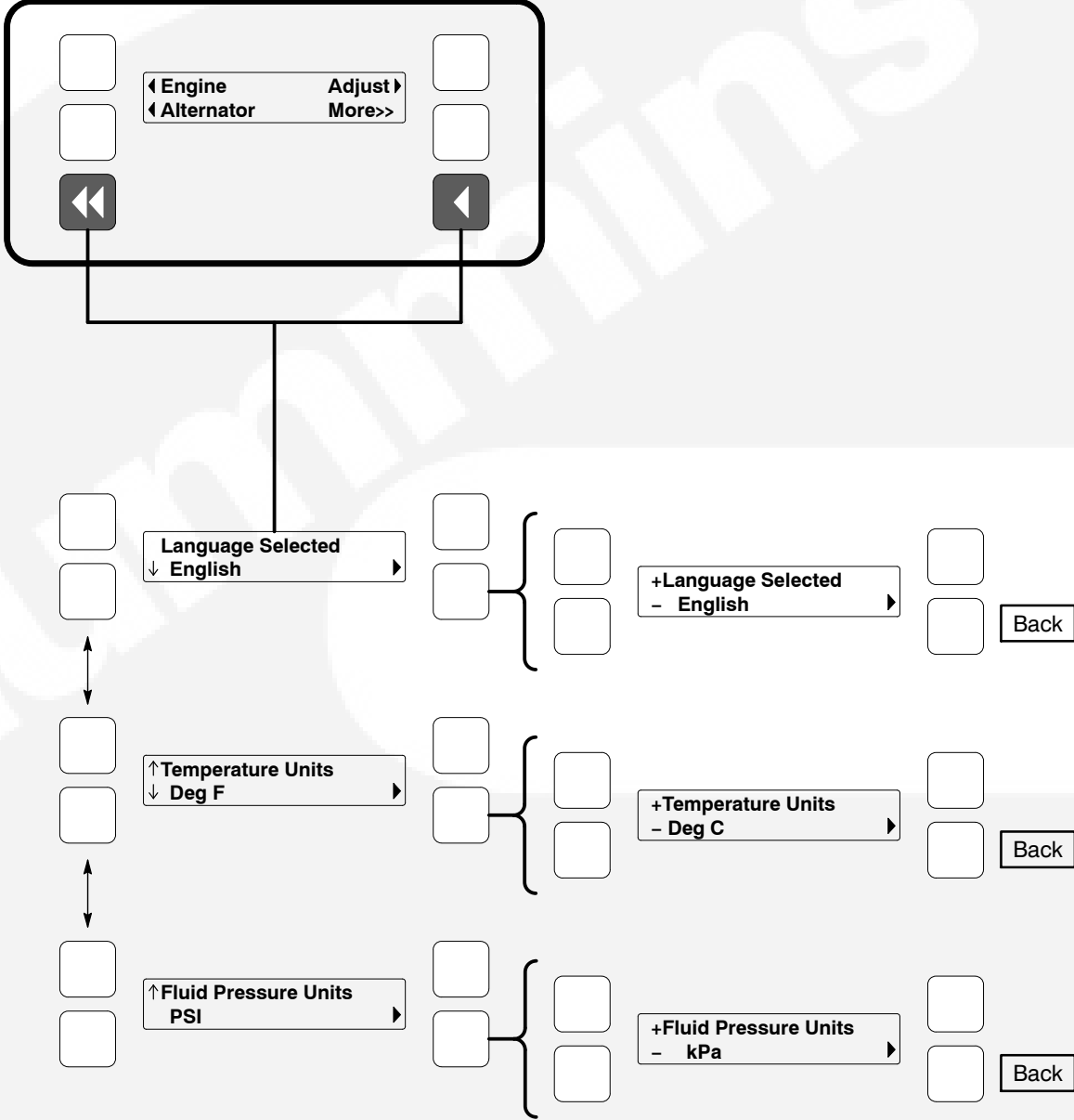

FIGURE 3-8. CONTROLLER CONFIGURATION MENU

## ENGINE MENU

Figure 3-9 shows a block representation of the Engine menu. If you press the button next to the word “Engine” in the display, the first Engine submenu is displayed.

As shown in the diagram, the Engine menu has seven submenus. The data in the submenus will vary according to the type and number of sensors provided with the engine.

Press the buttons next to the ↓ and ↑ symbols in the digital display to navigate between the menus. Press the Home button or the Previous Main Menu button to return to Main Menu 1.

**Coolant Temperature submenu:** This submenu displays the engine coolant temperature which can be viewed in degrees Fahrenheit or Centigrade (see *Controller Configuration Menu* in this section).

**Oil Pressure submenu:** This submenu displays the engine oil pressure which can be viewed in PSI or kPA (see *Controller Configuration Menu* in this section).

**Oil Temperature submenu (Only available on some models):** This submenu displays the engine oil temperature which can be viewed in degrees Fahrenheit or Centigrade (see *Controller Configuration Menu* in this section).

**Engine Speed submenu:** This submenu displays the engine RPM.

**Battery Voltage submenu:** This submenu displays the engine battery voltage.

**Governor Duty Cycle submenu:** This submenu displays the governor duty cycle (drive) levels in percentage of maximum.

**Active Time Delay submenu:** This submenu displays the time delay that is currently active: warm-up, cool down, start or stop delays.



# ENGINE MENU

## Main Menu 1

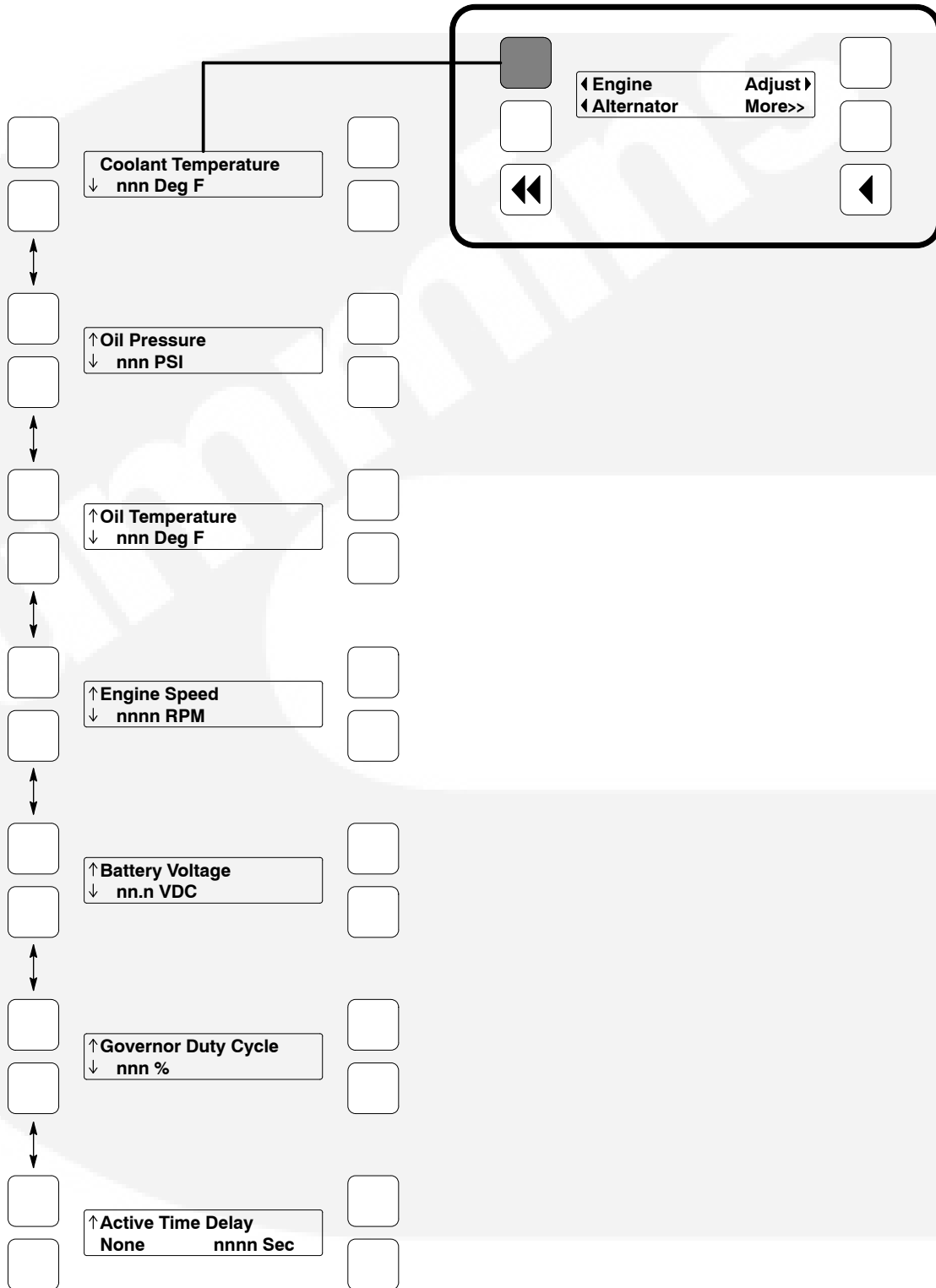

FIGURE 3-9. ENGINE MENU

## ALTERNATOR MENU

Figure 3-10 shows a block representation of the Alternator menu. If you press the button next to the word “Alternator” in the display, the first Alternator submenu is displayed.

As shown in the diagram, the Alternator menu has eleven submenus.

Press the buttons next to the ↓ and ↑ symbols in the digital display to navigate between the menus. Press the Home button or the Previous Main Menu button to return to Main Menu 1.

**Line-to-Line Voltage submenu:** The voltages Line-to-Line (L1, L2 and L3) are measured between L1 to L2, L2 to L3 and L3 to L1, respectively. (Single phase – L1 to L2 only.)

**Line-to-Neutral Voltage submenu:** Note that the Line-to -Neutral menu will not be displayed for a 3 phase/3 wire system. Single phase – L1 to N and L2 to N.

**Amps submenu:** All phases. (Single phase – L1 and L2 only.)

**Frequency submenu:** Generator set output frequency.

**Total Real Power submenu:** This submenu displays the total amount of real power output, in kilowatts (kW).

**Real Power submenu:** This submenu displays the amount of real power output for L1, L2, and L3, in kilowatts (kW). (Single phase – L1 and L2 only.)

**Total Apparent Power submenu:** This submenu displays the total amount of apparent power output, in kilovolt amps (kVA).

**Apparent Power submenu:** This submenu displays the amount of apparent power output for L1, L2, and L3, in kilovolt amps (kVA). (Single phase – L1 and L2 only.)

**Total Power Factor submenu:** This submenu displays the power factor with leading/lagging indication.

**The PF reading will contain an asterisk if the power factor is leading (for example, Total PF 0.9 \*).**

**Power Factor submenu:** This submenu displays a power factor value for L1, L2, and L3. (Single phase – L1 and L2 only.)

**The PF reading will contain an asterisk if the power factor is leading (for example, PF L1 0.9\*).**

**AVR Duty Cycle submenu:** This submenu displays the voltage regulator (drive) level in percentage of maximum. (Where maximum is 100% Duty Cycle, software clamps Duty Cycle maximum to 60% for PMG and 90% for shunt.)





# ALTERNATOR MENU

## Main Menu 1

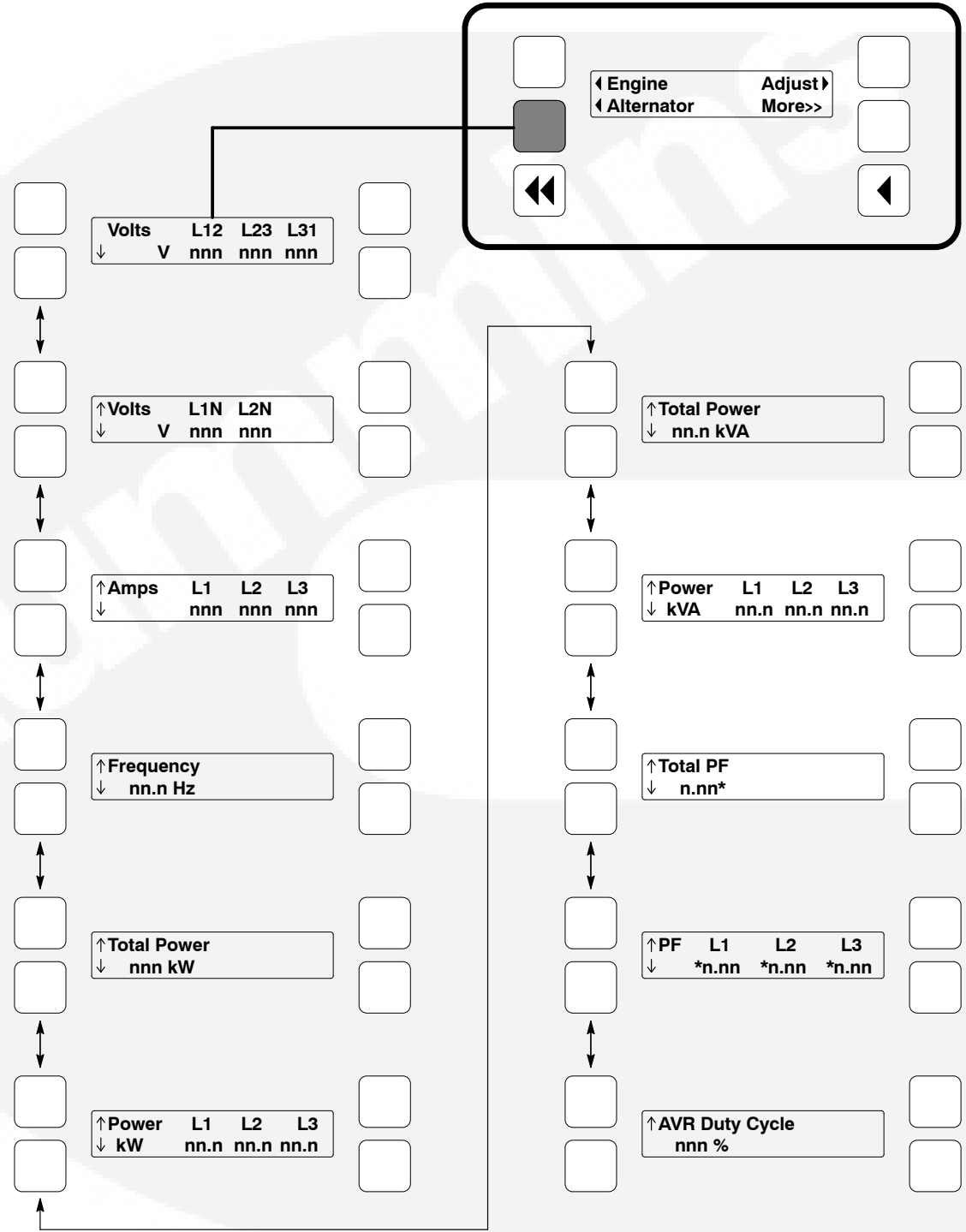

FIGURE 3-10. ALTERNATOR MENU

## ADJUST MENU

Figure 3-11 shows a block representation of the Adjust menu. If you press the button next to the word “Adjust” in the display, the first Adjust submenu is displayed.

As shown in the diagram, the Adjust menu has five submenus. Each submenu includes a parameter or value that can be changed.

Press the buttons next to the ↓ and ↑ symbols in the digital display to navigate between the menus. Press the Home button or the Previous Main Menu button to return to Main Menu 1.

### **Adjusting Values/Parameters:**

1. Press the button next to the ► symbol in the display until the + and – symbols are displayed.
2. If necessary, press the button next to the < or > symbols to move to the numeric character you wish to change.
3. Press the button next to the + symbol to increase the value or select parameter; press the button next to the – symbol to decrease the value or select parameter.
4. After adjusting values/selecting parameters, pressing the ► symbol results in the changes being saved. (When adjusting values, make sure the cursor is on the last numeric character before pressing the ► symbol).

If the Home button or Previous Main Menu button is pressed before pressing the ► symbol, the changes are not saved.

**Voltage Adjust submenu:** Voltage can be adjusted to  $\pm 5$  percent of the nominal voltage. For example, if genset output voltage is 208 volts, the voltage can be adjusted from 198 to 218 volts.

**If the displayed value is greater or less than the allowed (5%) range, the control will not accept the entry and will return to the previous setting. Retry by entering a smaller change in one volt increments.**

**Frequency Adjust submenu:** Frequency can be adjusted to  $\pm 5$  percent of the nominal frequency. For example, if the genset frequency is 60.0 Hz, the frequency can be adjusted from 57.0 to 63.0 Hz.

**Start Delay submenu:** Start Delay can be set from 0 to 300 seconds (default = 0). (Enter 1 or more to enable.) This function is bypassed during a manual start/stop sequence.

**Stop Delay submenu:** Stop Delay can be set from 0 to 600 seconds (default = 0). (Enter 1 or more to enable.) This function is bypassed during a manual start/stop sequence and engine shutdown faults.

**Rated To Idle (Beginning Version 2.303):** Rated To Idle delay can be set from 0 to 10 seconds (default = 0). (Enter 1 or more to enable.) Entering a non-zero delay will cause the genset to delay the transition to Cooldown At Idle.

**Idle Start submenu (Only available on some models):** Idle Start can be enabled or disabled (default = Disable). This function is only enabled when the genset is started in manual mode. Idle Start can also be enabled while the generator set is running in manual mode. (Auto/remote start is not affected by this setting.)

Enabling Idle Start will cause the genset to run in idle mode until Idle Start is disabled. A warning is displayed if genset is left in idle more than 10 minutes. Long periods of engine idling can eventually affect engine performance and may void engine warranty.

# ADJUST MENU

## Main Menu 1

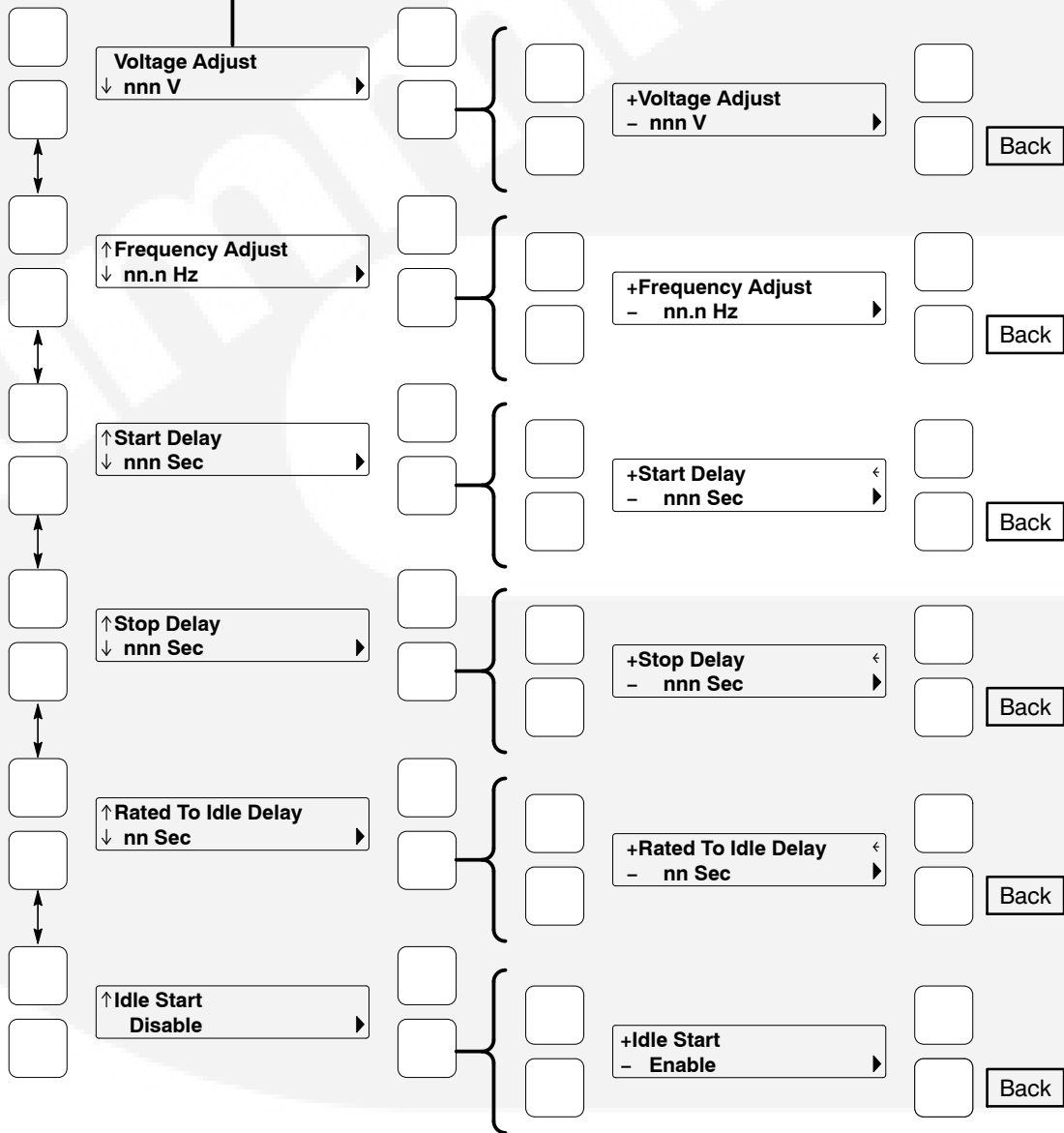
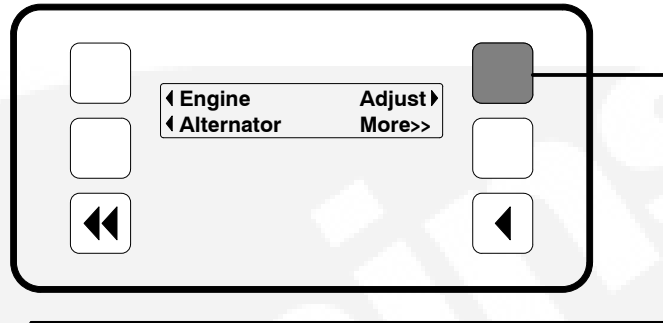

FIGURE 3-11. ADJUST MENU

## FAULTS MENU

Figure 3-13 shows a block representation of the Faults menu. Up to 20 of the most recent faults can be viewed. An example of how a fault code is displayed is shown in Figure 3-12.

The available menus are dependent on the number of faults that have occurred.

- If there are *no faults*, the ◀ symbol next to the word “Faults” is not displayed and no Fault menus are available.
- If *more than one fault* has occurred, press the button next to the word “Fault” in the screen display to view the Faults Main Menu. As shown in the diagram, the Faults Main Menu has two submenus. Press the Previous Main Menu button to return to the Faults Main Menu. Press the Previous Main Menu button a second time to return to Main Menu 2.

Press the Home button at any time to return to Main Menu 1.

**History submenu:** From the Faults Main Menu, press the button next to the word “History” in the display to view up to twenty of the most recent acknowledged faults. Press the buttons next to the ↓ and ↑ symbols in the digital display to navigate between the menus. Press the Previous Main Menu button to return to the Faults Main Menu.

**Current Fault submenu:** From the Faults Main Menu, press the button next to the word “Current” in the display to view up to twenty of the most recent unacknowledged faults. Press the Previous Main Menu button to return to the Faults Main Menu.

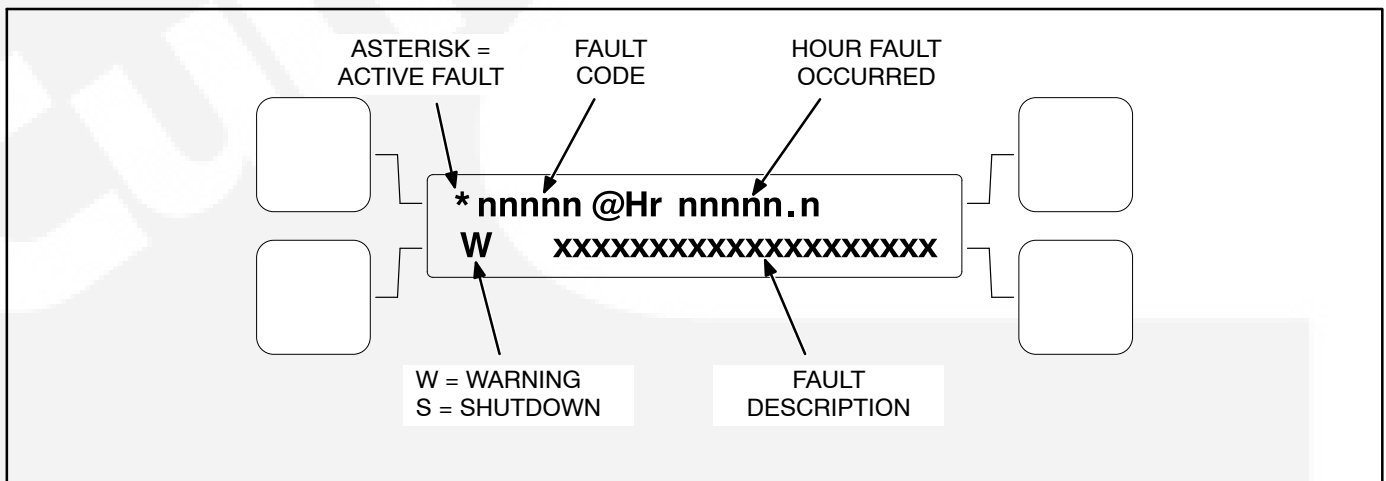

FIGURE 3-12. HISTORY/CURRENT FAULT SUBMENU

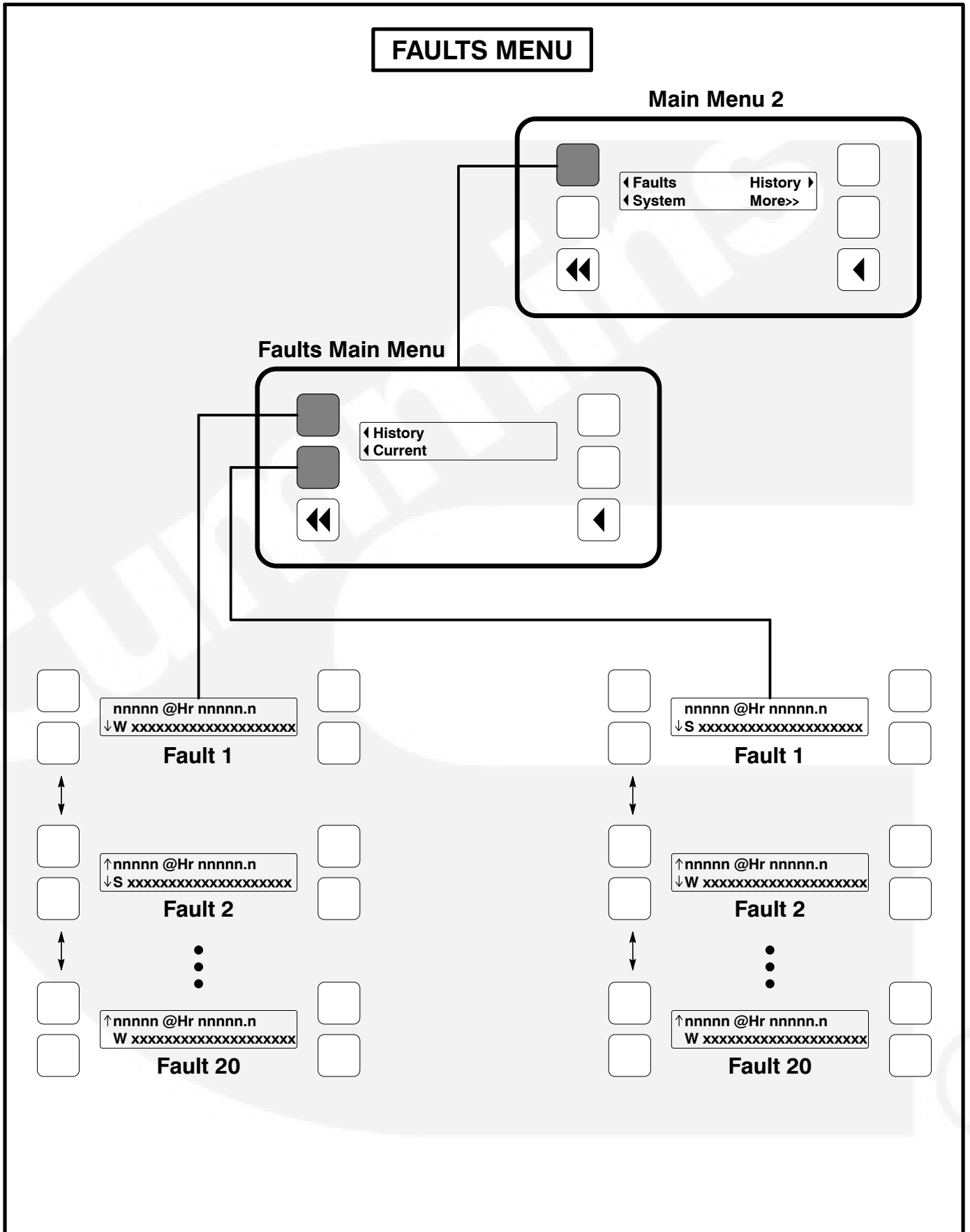

FIGURE 3-13. FAULTS MENU

## SYSTEM MENU

Figure 3-14 shows a block representation of the System menu. If you press the button next to the word “System” in the display, the System Main Menu is displayed. This menu is displayed only if the network communications module (NCM) feature is installed. The System Main Menu allows you to view the status and load of other PCC equipment connected on a common network with the PCC 2100 control.

As shown in the diagram, the System Main Menu has three submenus.

When viewing ATS and Genset System submenus, press the buttons next to the ↓ and ↑ symbols in the digital display to navigate between the menus. Press the Previous Main Menu button to return to the System Main Menu. Press the Previous Main Menu button a second time to return to Main Menu 2. Press the Home button to return to Main Menu 1.

**ATS System submenus:** From the System Main Menu, press the button next to the word “ATS” in the display to view the first of up to 16 ATS System submenus. An ATS system must be available in the network to display this submenu.

The ATS submenu allows viewing of the transfer switch name (configured with InPower), kW load (if monitored by the ATS system), status (e.g., not in auto), and source connected and availability (ON = source connected, OK = source available, or NA = source not available).

**Master System submenu:** From the System Main Menu, press the button next to the word “Master” in the display to view the Master System submenu. A master controller must be available in the network to display this submenu.

The master submenu allows viewing of the master controller name (configured with InPower), kW load and operational state.

**Genset System submenus:** From the System Main Menu, press the button next to the word “Genset” in the display to view the first of up to 16 Genset System submenus. One genset must be available in the network to display this submenu.

The genset submenu allows viewing of the genset name (configured with InPower), kW load and operational state.

**If a PCC 2100 control genset, in the network, contains the Power Transfer Control (PTC) feature, a genset system submenu will be displayed for the genset and the ATS System submenu will be displayed for the PTC feature.**

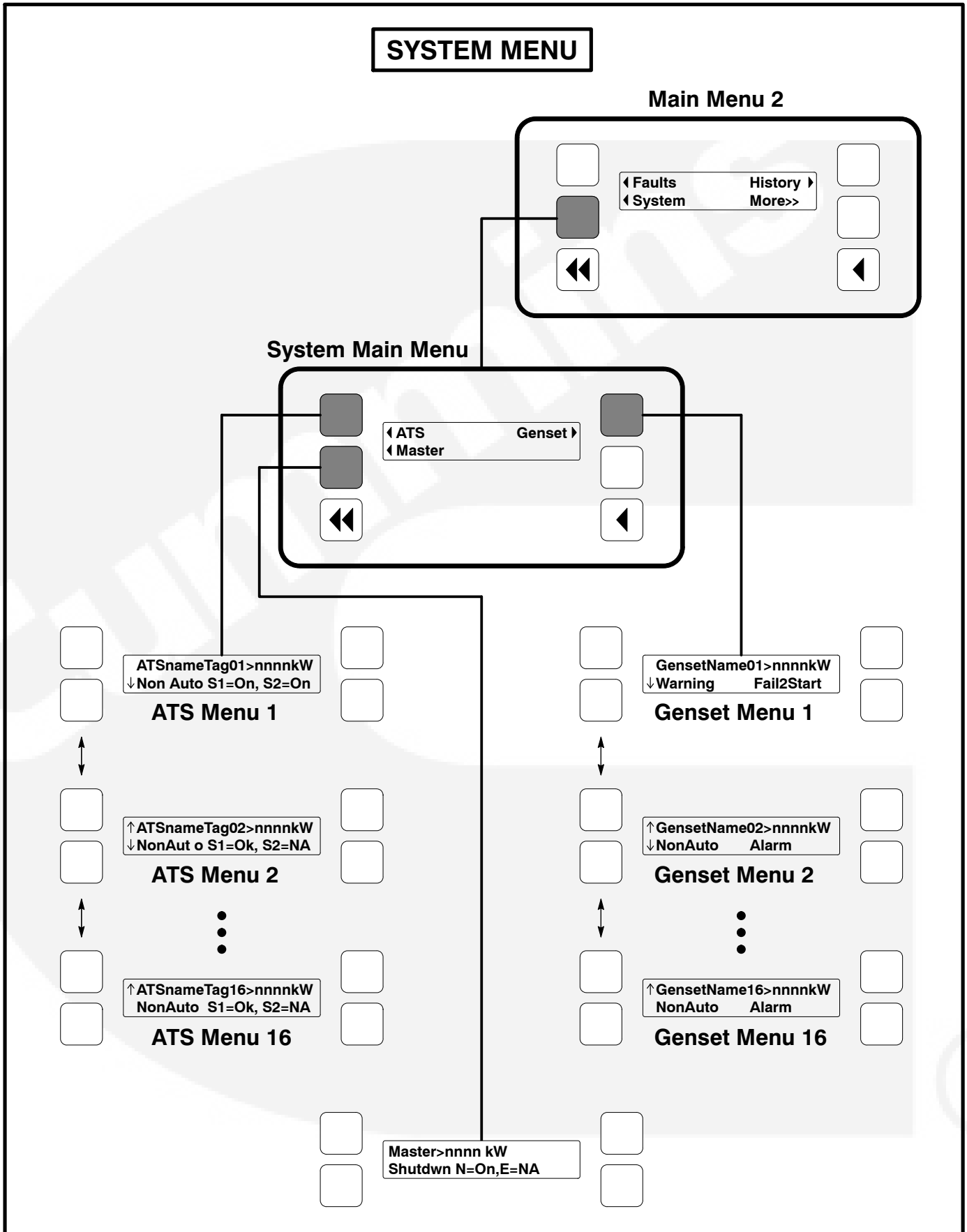

FIGURE 3-14. SYSTEM MENU

## HISTORY MENU

Figure 3-15 shows a block representation of the History menu. If you press the button next to the word “History” in the display, the first History submenu is displayed.

As shown in the diagram, the History menu has five submenus. This information is stored in non-volatile memory and will not be deleted due to loss of battery power.

Press the buttons next to the ↓ and ↑ symbols in the digital display to navigate between the menus. Press the the Previous Main Menu button to return to Main Menu 2. Press the Home button to return to Main Menu 1.

**Number of Starts submenu:** This submenu shows the number of engine starts.

**Engine Hours submenu:** This submenu shows the number of operating hours for the engine.

**Control Hours submenu:** This submenu shows the number of operating hours for the control.

**Kilowatt Hours submenu:** This submenu shows the number of kilowatt (kW) or megawatt (MW) hours.

**Genset Duty Cycle submenu:** This submenu shows the percent of genset operating hours that are less than 30 percent of rated load and percent of hours that are greater than 90 percent.





# HISTORY MENU

## Main Menu 2

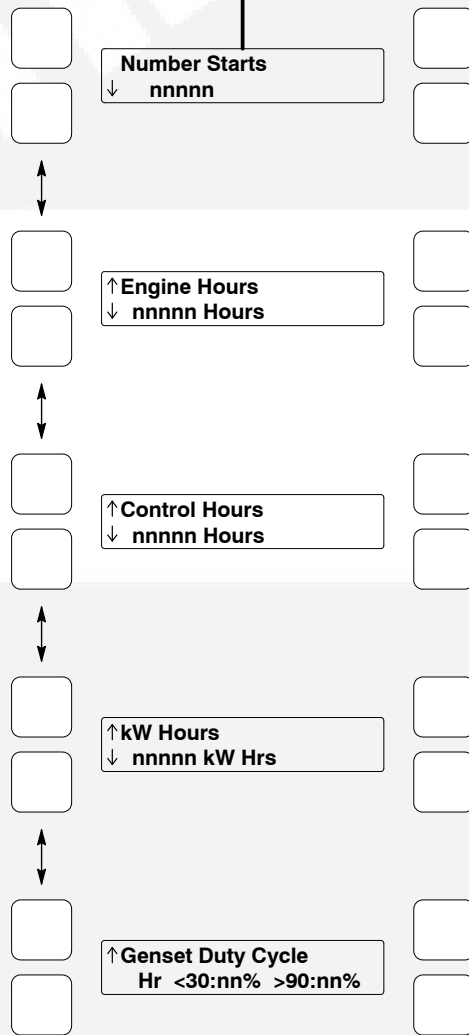
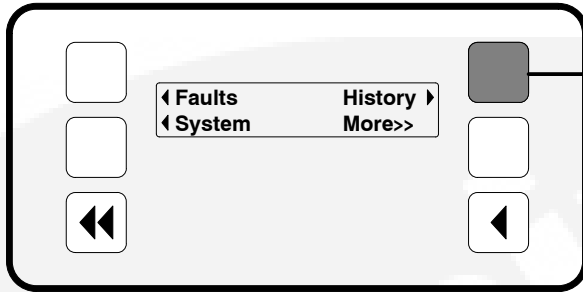

FIGURE 3-15. HISTORY MENU

## ABOUT MENU

Figure 3-16 shows a block representation of the About menu. If you press the button next to the word “About” in the display, the first About submenu is displayed.

As shown in the diagram, the About menu has three submenus.

Press the buttons next to the ↓ and ↑ symbols in the digital display to navigate between the menus. Press the the Previous Main Menu button to return to Main Menu 3. Press the Home button to return to Main Menu 1.

**Model submenu:** This submenu shows the genset model.

**Rating submenu:** This submenu shows the rating (Standby or Prime and number of kilowatts (kW)).

**Software Version submenu:** This submenu shows the software version level. This information is required to service the generator set.



# ABOUT MENU

## Main Menu 3

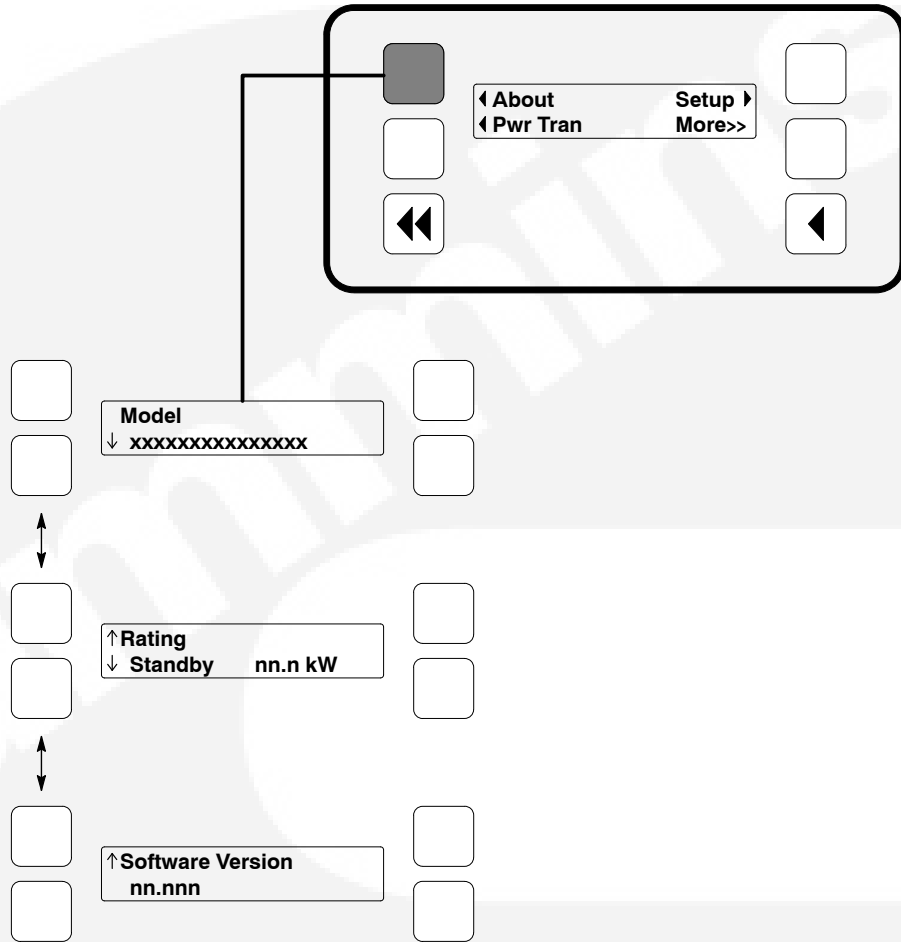

FIGURE 3-16. ABOUT MENU

## POWER TRANSFER MENU

Figure 3-17 shows a block representation of the Power Transfer menu. If you press the button next to the word “Pwr Tran” in the display, the first Power Transfer submenu is displayed. The Power Transfer Control (PTC) feature must be installed to display this submenu.

The PTC module enables the PCC to monitor the utility voltage (mains) and frequency for failure and control the opening and closing of the contacts (circuit breakers) for Source 1 (S1 utility) and Source 2 (S2 genset).

If S1 power fails, the control will initiate the starting sequence (Figure 3-3), open S1 and close S2 to the load. When S1 returns, the load is retransferred to S1 and the control initiates the genset shutdown sequence.

As shown in the diagram, the Power Transfer menu has five submenus.

Press the buttons next to the ↓ and ↑ symbols in the digital display to navigate between the menus. Press the the Previous Main Menu button to return to Main Menu 3. Press the Home button to return to Main Menu 1.

**S1 (Source 1) submenu:** This submenu shows power transfer source voltage. The voltages Line-to-Line (L1, L2 and L3) are measured between L1 to L2, L2 to L3 and L3 to L1, respectively. (Single phase – L1 to L2 only.)

**S1 (L-N Source) submenu:** This submenu is displayed only if the control system is configured for line-to-neutral voltage sensing of source 1. Single phase only – L1 to N and L2 to N.

**Frequency submenu:** This menu shows power transfer source frequency.

**Source 1 submenu:** This submenu shows utility status (On, Ok, or NA). “On” means Source 1 is connected and available. “Ok” means Source 1 is available but not connected. “NA” means Source 1 is not available.

**Genset submenu:** This submenu shows generator status (On, Ok, or NA). “On” means the genset is connected and available. “Ok” means the genset is available but not connected. “NA” means the genset is not available.

**Active Transfer Timer submenu:** This submenu shows the time delay, in seconds.



# POWER TRANSFER MENU

## Main Menu 3

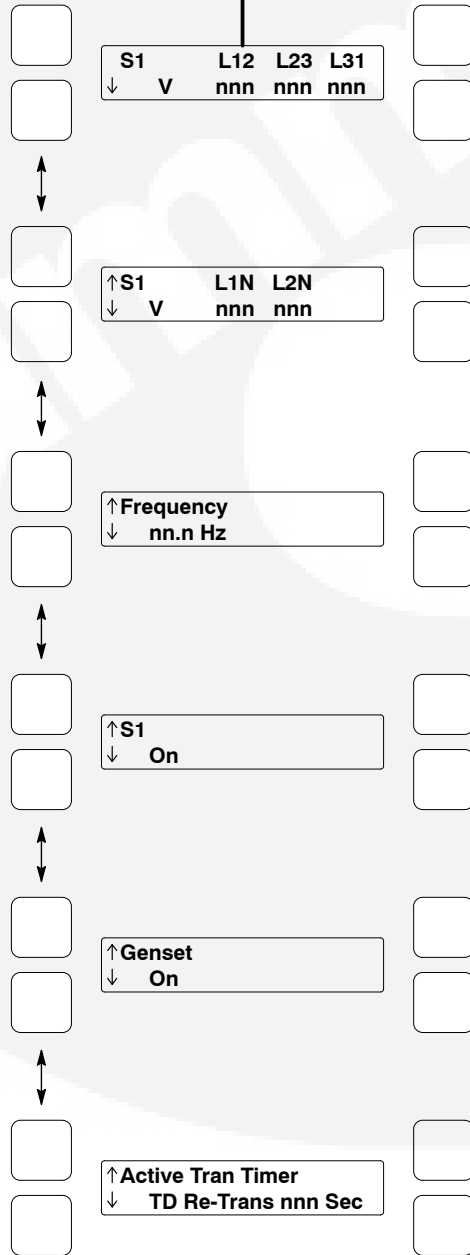
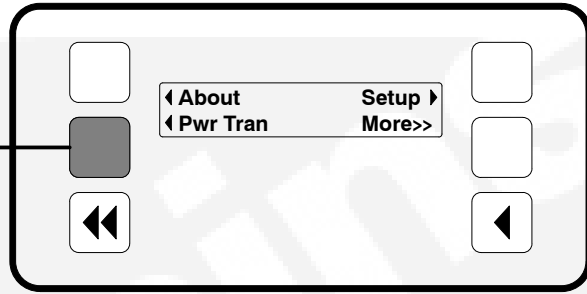

FIGURE 3-17. POWER TRANSFER MENU



**THIS PAGE LEFT INTENTIONALLY BLANK**



# 4. Troubleshooting

---

## GENERAL

The genset control continuously monitors engine sensors for abnormal conditions, such as low oil pressure and high coolant temperature. If any of these conditions occur, the control will light a yellow Warning lamp or a red Shutdown lamp and display a message on the digital display.

This section lists the warning and shutdown codes/messages (Table 4-1), and suggests troubleshooting procedures (Table 4-2).

Displayed error codes that are not listed in Table 4-2 will require an authorized service representative to correct the fault. Contact an authorized service center for assistance.

## SAFETY CONSIDERATIONS

**⚠️ WARNING** *Contacting high voltage components can result in severe personal injury or death. Keep the output box covers in place during troubleshooting.*

High voltages are present when the set is running. Do not open the generator output box while the set is running.

**⚠️ WARNING** *Ignition of explosive battery gases can cause severe personal injury or death. Arcing at battery terminals, light switch or other equipment, flame, pilot lights and sparks can ignite battery gas. Do not smoke, or switch trouble light ON or OFF near battery. Discharge static electricity from body before touching batteries by first touching a grounded metal surface.*

*Ventilate battery area before working on or near battery—Wear goggles—Stop genset and disconnect charger before disconnecting battery cables—Disconnect negative (-) cable first and reconnect last.*

**⚠️ CAUTION** *Disconnect battery charger from AC source before disconnecting battery cables. Otherwise, disconnecting cables can result in voltage spikes damaging to DC control circuits of the generator set.*

**⚠️ WARNING** *Accidental starting of the generator set can cause severe personal injury or death. Prevent accidental starting by disconnecting the negative (-) cable from the battery terminal.*

When troubleshooting a set that is shut down, make certain the generator set cannot be accidentally restarted as follows:

1. Move the O/Manual/Auto switch on the control panel to the O (off) position.
2. Turn off or remove AC power from the battery charger.
3. Remove the negative (-) battery cable from the generator set starting battery.



## STATUS INDICATORS

**Running Indicator:** This green lamp is lit whenever the generator set is running (Figure 4-1).

**Remote Start Indicator:** This green lamp is lit whenever the control is receiving a remote run signal.

**Not in Auto Indicator:** This red lamp flashes continuously when the O/Manual/Auto switch is not in the Auto position. (if in Auto position and the lamp is flashing, service is required.)

**Configurable Indicators:** Defaults for the configurable indicators shown in Figure 4-1 can be changed with the InPower service tool.

**Shutdown Status Indicator:** This red lamp is lit whenever the control detects a shutdown condition. The generator set cannot be started when this lamp is on. After the condition is corrected, shutdown indicators can be reset by turning the O/Manual/Auto switch to the O position and pressing the Fault Acknowledge/Reset button.

**Warning Status Indicator:** This yellow lamp is lit whenever the control detects a warning condition. After the condition is corrected, warning indicators can be reset by pressing the Fault Acknowledge/Reset button. (It may **not** be necessary to stop the generator set.) In auto mode, warning indicators

can also be reset by cycling the remote reset input after the condition is corrected.

**Some warnings remain active after the condition is corrected and the control reset button is pressed. This will require the genset to be shutdown to reset the warning indicator.**

**Digital Display:** This two-line, 20-characters per line alphanumeric display is used to view menus of the menu-driven operating system and to show warning and shutdown messages.

## LINE CIRCUIT BREAKER (OPTIONAL)

Optional line circuit breakers mount in the generator output box. If the load exceeds the circuit breaker current rating, the line circuit breaker will open, preventing the generator from being overloaded. If the circuit breaker trips, locate the source of the overload and correct as necessary. Manually reset the breaker to reconnect the load to the generator.

## CONTROL AND DIAGNOSTICS VIA NETWORK OR PERSONAL COMPUTER (LAPTOP)

See your authorized Cummins Power Generation dealer regarding software, hardware and network requirements for control and diagnostics via network or personal computer.





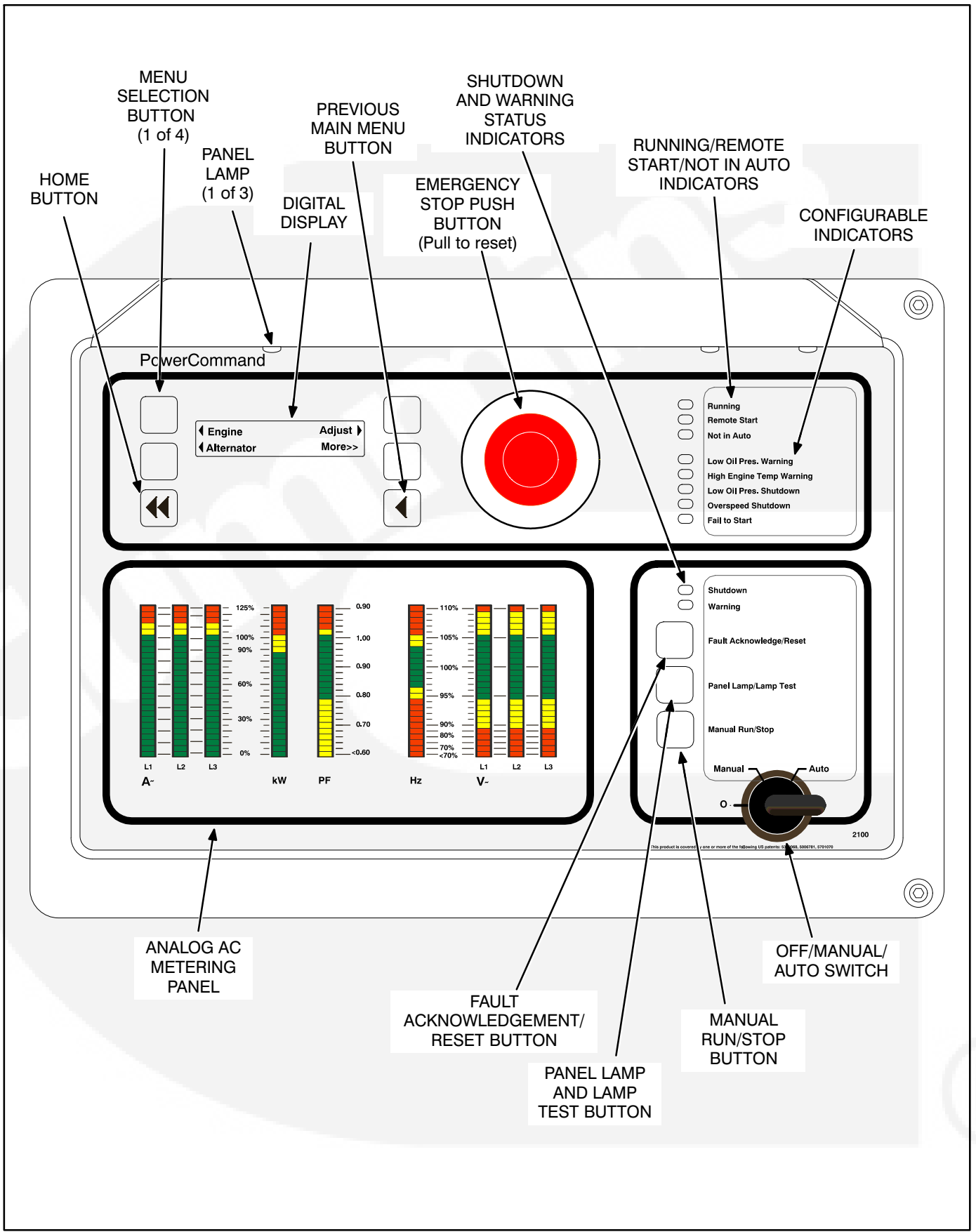

FIGURE 4-1. FRONT PANEL (FULL FEATURED)

## FAULT CODES

The fault codes have been divided into five categories to help you determine what corrective action to take for safe operation of the generator set. Use Table 4-1 to find the category (CTG) and fault description for all codes. *Gaps in the code numbers are for codes that do not apply to this genset.*

**Category A Fault Codes:** Pertain to engine or alternator shutdown faults that require immediate repair by qualified service personnel (generator set non-operational). The control prevents the generator set from being restarted if the shutdown fault is not corrected.

**Category B Fault Codes:** Consist of faults that can affect genset performance or cause **engine, alternator, or connected equipment damage**. Operate genset only when it is powering critical loads and cannot be shut down. Requires repair by qualified service personnel.

**Category C Fault Codes:** Consist of faults that do not affect generator set performance but require qualified service personnel to repair. These code indicate a defective harness or wiring problem.

These codes can also indicate a defective engine sensor, leaving no engine protection. (Engine damage can occur without detection.) **Continued operation may void generator set warranty if damage occurs that relates to fault condition.**

**Category D Fault Codes:** Consist of faults that are repairable by site personnel. Service will be required by qualified service personnel if site personnel cannot resolve the problem after taking the corrective actions suggested in Table 4-2.

**Category E Fault Codes:** Indicates non-critical operational status of generator set, external faults, or customer fault inputs. May require repair by qualified service personnel.

TABLE 4-1. FAULT CODES

CTG	CODE	LAMP	DISPLAYED MESSAGE
A	121	Shtdn	Speed Signal Lost
C	135	Wrng	Oil Pressure Sensor H
C	141	Wrng	Oil Pressure Sensor L
D	143	Wrng	Pre-Low Oil Pres
C	144	Wrng	Coolant Sensor High
C	145	Wrng	Coolant Sensor Low
D	146	Wrng	Pre-High Coolant Temp
D	151	Shtdn	High Coolant Temp
D	197	Wrng	Low Coolant Level
C	212	Wrng	Oil Temp Sensor H
C	213	Wrng	Oil Temp Sensor L

CTG	CODE	LAMP	DISPLAYED MESSAGE
A	234	Shtdn	Overspeed
D	235	Shtdn	Low Coolant Level
D	359	Shtdn	Fail To Start
D	415	Shtdn	Low Oil Pressure
D	421	Wrng	Oil Temp
D	441	Wrng	Low Bat Voltage
D	442	Wrng	High Bat Voltage
E	1122	None	Rated/Idle Trans
A	1123 *	Shtdn	Shutdown After Battle Short
E	1124	Wrng	Delayed Shutdown
E	1131 *	Wrng	Battle Sh Active

\* Refer to Battle Short Mode description in Section 3.

**TABLE 4-1. FAULT CODES (CONT.)**

CTG	CODE	LAMP	DISPLAYED MESSAGE
E	1311	Shtdn/ Wrng/ None	Customer Input #1
E	1312	Shtdn/ Wrng/ None	Customer Input #2
E	1313– 1316	Shtdn/ Wrng/ None	Network Fault 1 thru 4
E	1317	Shtdn/ Wrng/ None	Customer Input #3
E	1318	Shtdn/ Wrng/ None	Customer Input #4
A	1334	Shtdn	Crit Scaler Out Of Range
B	1335	Wrng	Noncrit Scaler Out Of Range
E	1337	None	No Message
C	1416 *	Wrng	Fail To Shutdown
D	1417	Wrng	Powr Down Error
D	1433	Shtdn	Emergency Stop
D	1434	Shtdn	Remote E-Stop
D	1435	Wrng	Low Coolant Temp
D	1438	Shtdn	Fail To Crank
D	1442	Wrng	Weak Battery
D	1443	Shtdn	Battery Failed
B	1444	Wrng	KW Overload
A	1445	Shtdn	Short Circuit
A	1446	Shtdn	High AC Voltage
A	1447	Shtdn	Low AC Voltage
A	1448	Shtdn	Under Frequency
A	1449	Wrng	Over Frequency

CTG	CODE	LAMP	DISPLAYED MESSAGE
A	1452	Wrng	Gen CB Not Close
A	1453	Wrng	Gen CB Not Open
A	1459	Shtdn	Reverse Power
A	1461	Shtdn	Loss Of Field
C	1466	Wrng	Modem Failure
C	1468	Wrng	Network Error
A	1469	Shtdn	Speed/Hz Match
B	1471	Wrng	Over Current
A	1472	Shtdn	Over Current
E	2323– 2326	Shtdn/ Wrng/ None	Network Fault 5 thru 8
B	2327	Wrng	PTC Fault
E	2329	Wrng	Low S1 Frequency
E	2331	Wrng	Low S1 Voltage
A	2335	Shtdn	Excitation Fault
A	2336	Shtdn	Memory Error
C	2337	Wrng	Pwr Tran Disabled
C	2338	Wrng	Pwr Tran Failure
E	2339	Wrng	Pwr Down Enabled
B	2341	Wrng	High Control Temp
E	2342	Wrng	Too Long In Idle (10 min.)
E	2358	Wrng	High S1 Voltage
E	2396	Wrng	S1 CB Not Close
E	2397	Wrng	S1 CB Not Open
C	2966	Wrng	PTC Timeout
C	2967	Wrng	Governor Fault
C	2968	Wrng	AVR Fault
C	2969	Wrng	LON Failure
A	2972	Shtdn	Field Overload

\* Refer to Battle Short Mode description in Section 3.

**⚠ WARNING** Hazards present in troubleshooting can cause equipment damage, severe personal injury or death. Only trained and experienced service personnel with knowledge of fuels, electricity, and machinery hazards should perform service procedures. Read Safety Precautions page and observe all instructions and precautions in this manual.

**TABLE 4-2. WARNING AND SHUTDOWN CODES**

FAULT CODE	CORRECTIVE ACTION
<b>143</b> <b>PRE-LOW OIL PRES</b> Lamp: Warning	Indicates engine oil pressure has dropped below the warning trip point.. If generator is powering critical loads and cannot be shut down, wait until next shutdown period and then follow code <b>415</b> procedure.
<b>146</b> <b>PRE-HIGH COOL TMP</b> Lamp: Warning	Indicates engine is operating near cooling system capacity. Increase in load or higher ambient temperature may cause High Coolant Temp ( <b>151</b> ) shutdown. Review <b>151</b> correction list for other possible causes.
<b>151</b> <b>HIGH COOLANT TEMP</b> Lamp: Shutdown	Indicates engine has overheated (coolant temperature has risen above the shutdown trip point). Allow engine to cool down completely before proceeding with the following checks: <ol style="list-style-type: none"> <li>a. Check coolant level and replenish if low. Look for coolant leaks and repair if necessary.</li> <li>b. Check for obstructions to cooling airflow and correct as necessary.</li> <li>c. Check fan belt and repair or tighten if necessary.</li> <li>d. Check blower fan and circulation pumps on remote radiator installations.</li> <li>e. Reset control and restart after locating and correcting problem.</li> </ol>
<b>197</b> <b>LOW COOLANT LEVEL</b> Lamp: Warning (Optional)	Indicates engine coolant level has fallen below the warning trip point. If generator is powering critical loads and cannot be shut down, wait until next shutdown period, then follow code <b>235</b> procedure. If engine can be stopped, follow code <b>235</b> procedure.
<b>235</b> <b>LOW COOLANT LEVEL</b> Lamp: Shutdown (Optional)	Indicates engine coolant level has fallen below the shutdown trip point. Allow engine to cool down completely before proceeding. <ol style="list-style-type: none"> <li>a. Check coolant level and replenish if low. Look for possible coolant leakage points and repair if necessary.</li> <li>b. Reset control and restart after locating and correcting problem.</li> </ol>
<b>359</b> <b>FAIL TO START</b> Lamp: Shutdown	Indicates possible fuel system or air induction problem. (Engine cranks but fails to start) <ol style="list-style-type: none"> <li>a. Check for empty fuel tank, fuel leaks, or plugged fuel lines and correct as required.</li> <li>b. Check for dirty fuel filter and replace if necessary.</li> <li>c. Check for dirty or plugged air filter and replace if necessary.</li> <li>d. Reset the control and restart after correcting the problem.</li> </ol>
<b>415</b> <b>LOW OIL PRESSURE</b> Lamp: Shutdown	Indicates engine oil pressure has dropped below the shutdown trip point. Check oil level. If oil level is low, replenish. Reset control and restart.

**⚠ WARNING** Hazards present in troubleshooting can cause equipment damage, severe personal injury or death. Only trained and experienced service personnel with knowledge of fuels, electricity, and machinery hazards should perform service procedures. Read Safety Precautions page and observe all instructions and precautions in this manual.

**TABLE 4-2. WARNING AND SHUTDOWN CODES (CONT.)**

FAULT CODE	CORRECTIVE ACTION
<b>421</b> <b>OIL TEMP</b> Lamp; Warning (Optional)	Indicates engine has begun to overheat (oil temperature has risen to an unacceptable level). If generator is powering non-critical and critical loads and cannot be shut down, use the following: <ol style="list-style-type: none"> <li>a. Reduce load if possible by turning off non-critical loads.</li> <li>b. Check air inlets and outlets and remove any obstructions to airflow.</li> </ol> If engine can be stopped, follow code <b>151</b> procedure and also check engine oil level.
<b>441</b> <b>LOW BAT VOLTAGE</b> Lamp: Warning	Indicates battery voltage supply to the control is approaching a low level at which unpredictable operation will occur. <ol style="list-style-type: none"> <li>a. Discharged or defective battery. Check the battery charger fuse. Recharge or replace the battery.</li> <li>b. Poor battery cable connections. Clean the battery cable terminals and tighten all connections.</li> <li>c. Check battery charge voltage float level if applicable (raise float level).</li> </ol>
<b>442</b> <b>HIGH BAT VOLTAGE</b> Lamp: Warning	Indicates battery voltage supply to the control is approaching a high level at which damage to the control can occur. Check float level on battery charger if applicable (lower float level).
<b>1311, 1312, 1317, 1318</b> <b>CUSTOMER INPUT #1 – #4</b> Lamp: Warning/Shutdown or none for status message.	The nature of the fault is an optional customer selection. Example inputs: Low Fuel Day Tank, Water In Fuel, Ground Fault, Low Starting Hydraulic Pressure, Low Starting Air Pressure, etc. Each of the fault functions can be programmed (using service tool), as follows: <ul style="list-style-type: none"> <li>• Enable/disable input (Default: enable)</li> <li>• Status, Warning or Shutdown (Default: #1–None, #2 thru #4–Warning)</li> <li>• Active closed or open (Default: closed [ground])</li> <li>• Change display name using up to 19 characters (Default: #1– Customer Fault 1, #2–Ground Fault, #3–Low Fuel, #4–Rupture Basin Fault)</li> </ul>
<b>1417</b> <b>POWER DOWN ERROR</b> Lamp: Warning	Indicates that the controller can not power down because of some unknown condition. Possible drain on battery. Contact an authorized service center for service.
<b>1433</b> <b>EMERGENCY STOP</b> Lamp: Shutdown	Indicates local Emergency Stop. To reset the local/remote Emergency Stop button: <ol style="list-style-type: none"> <li>4. Pull the button out.</li> <li>5. Move the O/Manual/Auto switch to O.</li> <li>6. Press the front panel Fault Acknowledge/Reset button.</li> <li>7. Return O/Manual/Auto switch to desired position.</li> </ol>

**⚠ WARNING** Hazards present in troubleshooting can cause equipment damage, severe personal injury or death. Only trained and experienced service personnel with knowledge of fuels, electricity, and machinery hazards should perform service procedures. Read Safety Precautions page and observe all instructions and precautions in this manual.

**TABLE 4-2. WARNING AND SHUTDOWN CODES (CONT.)**

FAULT CODE	CORRECTIVE ACTION
<b>1434</b> <b>REMOTE E-STOP</b> Lamp: Shutdown	Indicates remote Emergency Stop. See code <b>1433</b> to reset.
<b>1435</b> <b>LOW COOLANT TEMP</b> Lamp: Warning Set is not operating. Warning occurs when engine coolant temperature is 70° F (21° C) or lower. <b>NOTE: In applications where the ambient temperature falls below 40° F (4° C), Low Coolant Temp may be indicated even though the coolant heaters are operating.</b>	Indicates engine coolant heater is not operating or is not circulating coolant. Check for the following conditions: <ul style="list-style-type: none"> <li>a. Coolant heater not connected to power supply. Check for blown fuse or disconnected heater cord and correct as required.</li> <li>b. Check for low coolant level and replenish if required. Look for possible coolant leaks and repair as required.</li> </ul>
<b>1438</b> <b>FAIL TO CRANK</b> Lamp: Shutdown	Indicates possible fault with control, speed sensing or starting system. See code <b>441</b> for corrective action.
<b>1442</b> <b>WEAK BATTERY</b> Lamp: Warning	Indicates that during cranking, the battery voltage is at or below the weak battery warning trip point for a time greater than or equal to the weak battery set time. See code <b>441</b> for corrective action.
<b>1443</b> <b>BATTERY FAILED</b> Lamp: Shutdown	Dead battery – engine will not start. See code <b>441</b> for corrective action.
<b>2342</b> <b>TOO LONG IN IDLE</b> Lamp: Warning	Indicates genset has been in Idle mode too long (10 minutes maximum).

# 5. Maintenance

---

## GENERAL

Establish and adhere to a definite schedule for maintenance and service based on the application and severity of the environment. Table 5-1 covers the recommended service intervals for a generator set on STANDBY service. If the set will be subjected to extreme operating conditions, the service intervals should be reduced accordingly. Some of the factors that can affect the maintenance schedule are the following:

- Use for continuous duty (prime power)
- Extremes in ambient temperature
- Exposure to weather

- Exposure to salt water
- Exposure to dust, sand or other airborne contaminants

Consult with your local Cummins Power Generation distributor if the generator set will be subjected to any extreme operating conditions and determine a suitable schedule of maintenance. Use the running time meter (Figure 5-1) to keep an accurate log of all service performed for warranty support. Perform all service at the time period indicated or after the number of operating hours indicated, whichever comes first. Use Table 5-1 to determine the maintenance required and then refer to the sections that follow for the correct service procedures.



**TABLE 5-1. MAINTENANCE SCHEDULE**

MAINTENANCE ITEMS	SERVICE TIME				
	See Engine Schdl.	Daily or after 8 Hours	Weekly or after 50 Hours	Monthly or after 100 Hours	6 Months or after 250 Hours
General Genset Inspection	X <sup>1</sup>	X <sup>2</sup>			
Check Coolant Heater		X			
Check Oil Level		X			
Check Coolant Level		X			
Check Fuel Level		X			
Check Charge Air Piping		X			
Check Air Cleaner (Clean if required)			X <sup>3</sup>		
Check Battery Charging System			X		
Drain Water and Sediment from Fuel Tank			X <sup>5</sup>		
Drain Exhaust Condensate Trap				X	
Check Starting Batteries				X	
Change Air Cleaner Element					X <sup>3</sup>
Check Radiator Hoses for Wear & Cracks					X
Drain Fuel Filter(s)	X <sup>1</sup>				
Check Anti-freeze and DCA Concentration	X <sup>1</sup>				
Change Crankcase Oil and Filter	X <sup>1, 6</sup>				
Check Drive Belt Tension	X <sup>1</sup>				
Change Coolant Filter	X <sup>1</sup>				
Clean Crankcase Breather	X <sup>1</sup>				
Change Fuel Filters	X <sup>1</sup>				
Clean Cooling System	X <sup>1</sup>				
Adjust Valve Lash	After 1000 hours <sup>7</sup>				
Inspect Alternator Bearings	Inspect all sealed bearings every 4000 to 4500 hours (10000 hr/2 years).				
Replace Alternator Bearings	Replace all sealed bearings every 30000 hr/5 years (or if necessary after 10000 hr/2 years).				

- X<sup>1</sup> Refer to Cummins Engine Operation and Maintenance Manual for maintenance interval and/or procedure.
- X<sup>2</sup> Check for oil, fuel, cooling and exhaust system leaks. Check exhaust system audibly and visually with set running and repair any leaks immediately.
- X<sup>3</sup> Perform more often in dusty conditions.
- X<sup>4</sup> Visually check belt for evidence of wear or slippage. Replace if hard or brittle.
- X<sup>5</sup> Drain 1 cup or more of fuel to remove water and sediment.
- X<sup>6</sup> If genset is used for standby applications, change oil every 12 months or 250 hours, whichever comes first.
- X<sup>7</sup> Contact an authorized service center for service.



## GENERATOR SET INSPECTION

During operation, be alert for mechanical problems that could create unsafe or hazardous conditions. The following sections cover several areas that should be frequently inspected for continued safe operation.

### Exhaust System

With the generator set operating, inspect the entire exhaust system visually and audibly including the exhaust manifold, muffler and exhaust pipe. Check for leaks at all connections, welds, gaskets and joints and also make sure that exhaust pipes are not heating surrounding areas excessively. If any leaks are detected, shut down the genset and have leaks corrected immediately.

**⚠️WARNING** *Inhalation of exhaust gases can result in severe personal injury or death. Be sure deadly exhaust gas is piped outside and away from any windows, doors, vents or other inlets to building and not allowed to accumulate in inhabitable areas.*

### Fuel System

With the generator set operating, inspect the fuel supply lines, return lines, filters and fittings for cracks and abrasions and make sure they are not rubbing against anything that could cause breakage. If any leaks are detected, have them corrected immediately.

**⚠️WARNING** *Ignition of fuel can cause severe personal injury or death by fire or explosion. Do not permit any flame, cigarette, arcing switch or equipment, pilot light, or other igniter near the fuel system or in areas sharing ventilation.*

### AC Electric System

Check the following while the genset is operating.

**Frequency/RPM (Alternator/Engine Menu):** The generator frequency should be stable under load

and the reading should be the same as the genset nameplate rating (50 or 60 Hz/1500 or 1800 RPM). Under no-load conditions the frequency can vary between 50-53 or 60-63 Hz.

**AC Voltmeter (Alternator Menu):** At no load, the line-to-line or line-to-neutral voltage(s) should be the same as the genset nameplate rating.

**AC Ammeter (Alternator Menu):** At no load the current ratings should be zero. With a load applied, each line current should be about the same.

**Panel Lamp/Lamp Test Button:** Press and hold this button to test all front panel LEDs and meters. The meters will light one bar at a time. Make sure that all LEDs and meters are OK and then release the button.

### DC Electrical System

Check the terminals on the batteries for clean and tight connections. Loose or corroded connections create resistance which can hinder starting. Refer to *BATTERIES* later in this section for cleaning and safety precautions.

### Engine

Monitor fluid levels and oil pressure and coolant temperatures frequently. Most engine problems give an early warning. Look and listen for changes in engine performance, sound, or appearance that can indicate service or repair is needed. Some engine changes to look for are as follows:

- Misfire
- Vibration
- Unusual noises
- Sudden changes in engine operating temperatures or pressures
- Excessive exhaust smoke
- Loss of power
- An increase in oil consumption
- An increase in fuel consumption
- Fuel, oil, or coolant leaks.



## GENERATOR SET MAINTENANCE (Battery Disconnected)

**⚠WARNING** *Ignition of explosive battery gases can cause severe personal injury or death. Arcing at battery terminals, light switch or other equipment, flame, pilot lights and sparks can ignite battery gas. Do not smoke, or switch trouble light ON or OFF near battery. Discharge static electricity from body before touching batteries by first touching a grounded metal surface.*

*Ventilate battery area before working on or near battery—Wear goggles—Stop genset and disconnect charger before disconnecting battery cables—Disconnect negative (-) cable first and reconnect last.*

**⚠CAUTION** *Disconnect battery charger from AC source before disconnecting battery cables. Otherwise, disconnecting cables can result in voltage spikes damaging to DC control circuits of the set.*

**⚠WARNING** *Accidental starting of the generator set can cause severe personal injury or death. Prevent accidental starting by disconnecting the negative (-) cable from the battery terminal before beginning maintenance procedures.*

When performing the following maintenance procedures, make certain the generator set cannot be accidentally restarted as follows:

1. Move the O/Manual/Auto switch on the control panel to the O (off) position.
2. Turn off or remove AC power from the battery charger.
3. Remove the negative (-) battery cable from the generator set starting battery.

### **Mechanical Inspection**

With the generator set stopped, check for loose belts and fittings, leaking gaskets and hoses, or any signs of mechanical damage. If any problems are found, have them corrected immediately.



## LUBRICATION SYSTEM

**Gensets are shipped with oil added. Be sure to check oil level before initial start.**

### Oil API Classification

Refer to the Cummins engine *Operation and Maintenance Manual* for lubricating oil classification.

### Oil Viscosity

Refer to the Cummins engine *Operation and Maintenance Manual* for lubricating oil recommendations/specifications.

### Engine Oil Level

Check the engine oil level during engine shutdown periods at the intervals specified in the Maintenance Table. The oil filter location is shown in Figure 5-2. The dipstick is stamped with high and low marks to indicate the level of oil in the crankcase.

For accurate readings, shut off the engine and wait approximately 15 minutes before checking the oil level. This allows oil in the upper portion of the engine to drain back into the crankcase. The dipstick and oil fill are located on the same side of the engine as shown in Figure 5-3.

**⚠ WARNING** *Crankcase pressure can blow out hot oil and cause severe burns. Do NOT check oil while the generator set is operating.*

Keep the oil level as near as possible to the high mark on the dipstick. Remove the oil fill cap (see Figure 5-3) and add oil of the same quality and brand when necessary. Install the oil fill cap after adding oil.

**⚠ CAUTION** *Do not operate the engine with the oil level below the low mark or above the high mark. Overfilling can cause foaming or aeration of the oil while operation below the low mark may cause loss of oil pressure.*



## OIL AND FILTER CHANGE

Change the oil and filter at the intervals recommended in the maintenance table. Use oil that meets Cummins recommendations/specifications.

### Engine Oil Change

Refer to the Cummins engine *Operation and Maintenance Manual* for lubricating oil and filter changing procedure. Refer to *Specifications* in Section 2 of this manual for oil capacity. Use oil that meets Cummins recommendations/specifications.

**⚠WARNING** *State or federal agencies have determined that contact with used engine oil can cause cancer or reproductive toxicity. Do not contact oil or breath vapors. Use rubber gloves and wash exposed skin.*

*Used oil and filters must be disposed of properly to avoid environmental damage and clean-up liability. Check all federal, state and local regulations for disposal requirements.*

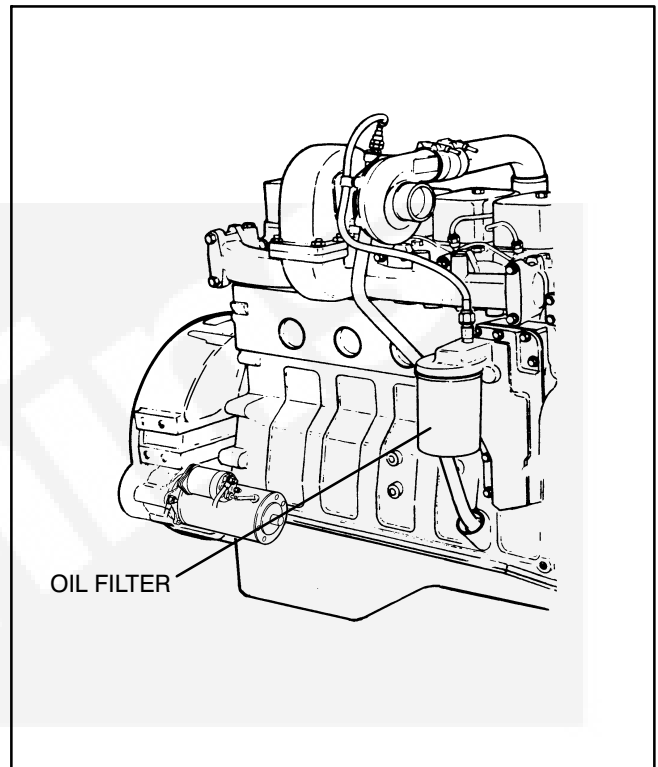

FIGURE 5-1. OIL FILTER

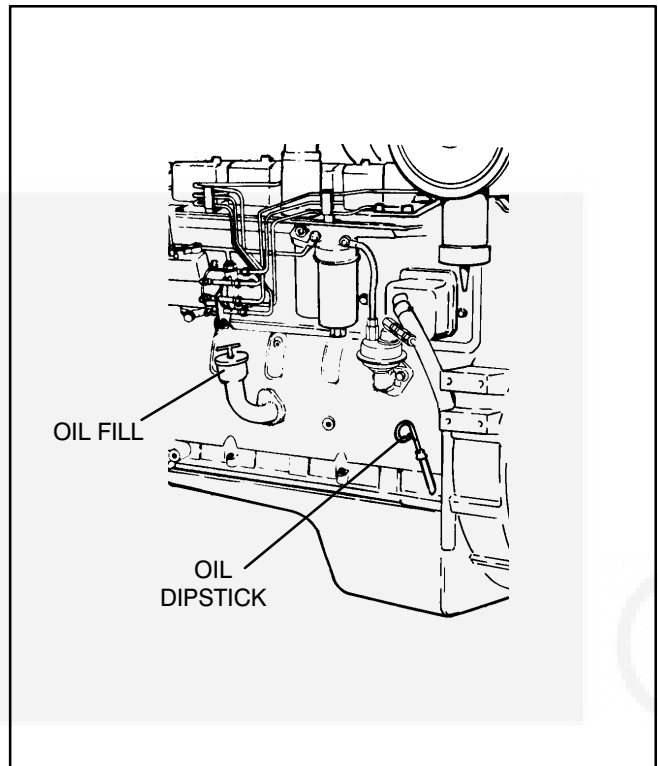

FIGURE 5-2. OIL FILL AND DIPSTICK LOCATIONS

## COOLING SYSTEM

Gensets are shipped with coolant added. Be sure to check coolant level before initial start.

**CAUTION** *The coolant heater must not be operated while the cooling system is empty or when the engine is running or damage to the heater will occur.*

**CAUTION** *Do not add cold coolant to a hot engine. Engine castings can be damaged. Allow the engine to cool to below 120° F (50° C) before adding coolant.*

### Coolant Level

**With Coolant Recovery Tank:** Check the recovery tank coolant level during shutdown periods at the interval specified in Table 5-1. Also, make sure that the coolant recovery system is working (no air leaks), by checking the coolant level in the radiator at least once a year. Coolant level at top of radiator indicates that the coolant recovery system is working. If radiator coolant level is low and the coolant level in the coolant recovery tank is correct, this would indicate a defective radiator cap or an air leak in either the radiator to coolant tank hose or the tube in the recovery tank. Repair as necessary.

Always keep level in the coolant recovery tank between LOW and FULL.

**Without coolant recovery tank:** Check the coolant level during shutdown periods at the intervals specified in the Maintenance Table. Remove the radiator cap after allowing the engine to cool and if necessary, add coolant until the level is near the top of the radiator.

Refer to the Cummins engine *Operation and Maintenance Manual* for coolant recommendations/specifications.

**WARNING** *To prevent severe scalding, let engine cool down before removing coolant pressure cap. Turn cap slowly, and do not open it fully until the pressure has been relieved.*

**CAUTION** *Loss of coolant can allow engine to overheat without protection of shutdown device and cause severe damage to the engine. Maintain coolant level for proper operation of the high engine temperature shutdown system.*

### Coolant Requirements

Heavy duty diesel engines require a balanced coolant mixture of water, antifreeze and coolant additives.

Refer to the Cummins engine *Operation and Maintenance Manual* for all cooling system maintenance, such as, coolant requirements, filling of cooling system, coolant filter replacement and flushing and cleaning.

### Radiator

Inspect the exterior of the radiator for obstructions. Remove all dirt or foreign material with a soft brush or cloth. Use care to avoid damaging the fins. If available, use low pressure compressed air or stream of water (maximum of 35 psi/242 kPa), in opposite direction of normal air flow to clean radiator. If using water, protect the engine and the generator from over spray.

### Coolant Heater

Check the operation of the coolant heater by verifying that hot coolant is being discharged from the outlet hose. **Do not touch outlet hose** – if heater is operational, radiant heat should be felt with hand held close to outlet hose.

**WARNING** *Contact with cooling system or engine can result in serious burns. Do not touch cooling system or engine during genset maintenance until they are cool.*

## CHARGE AIR COOLER SYSTEM

Refer to the Cummins engine *Operation and Maintenance Manual* for the instructions to perform the charge air cooler system maintenance checks.

## FUEL SYSTEM

Refer to the Cummins engine *Operation and Maintenance Manual* for fuel system maintenance.

## AIR CLEANER

The filter element should be replaced yearly or sooner if the service indicator button pops up indicating air restriction. Two types of air filter assemblies are used on the generator set. Refer to Figure 5-3 to determine which procedure to use to replace the air filter.

The vacuator valve dumps collected dust automatically.

Inspect all components of the air filtering system including all ducts and hoses. Verify that all connections and clamps are tight and inspect each component for cracks, dents, or other damage. Repair or service as required.

**⚠ CAUTION** *Filters should be handled with care to prevent damage. If the filter does become damaged, install recommended replacement part.*

The following procedure should be followed when replacing the element.

### Type A Filter Assembly

1. Release the three cover clips and remove the air cleaner cover.
2. Slowly remove the air filter to reduce the amount of dust dislodged. There may be some initial resistance when removing the filter.

Gently move the end of the filter up and down and side to side or twist to break the seal.

3. Wipe out the interior of the air cleaner housing and cover with a clean, damp cloth. Make sure that **ALL** dust is removed from **ALL** interior surfaces of the air cleaner housing. Be careful not to damage the sealing area on the outlet tube.
4. Inspect new air filter for shipping damage. Pay attention to the inside of the open end (sealing area). Do not install a damaged filter.
5. Install new air filter. The seal area is on the inside of the open end of the filter. The sealing area will stretch slightly and adjust itself over the outlet tube. To complete the seal, apply pressure at the outer rim of the filter, not the flexible center. No cover pressure is required to hold the seal.
5. Put on the air cleaner cover and secure with the three cover clips.

### Type B Filter Assembly

1. Remove the air cleaner cover.
2. Remove thumb screw and gasket washer, then remove the element from air cleaner.
3. Wipe out the interior of the air cleaner housing and cover with a clean, damp cloth.
4. Install new element and secure with gasket washer and thumb screw.
5. Put on the air cleaner cover and secure.

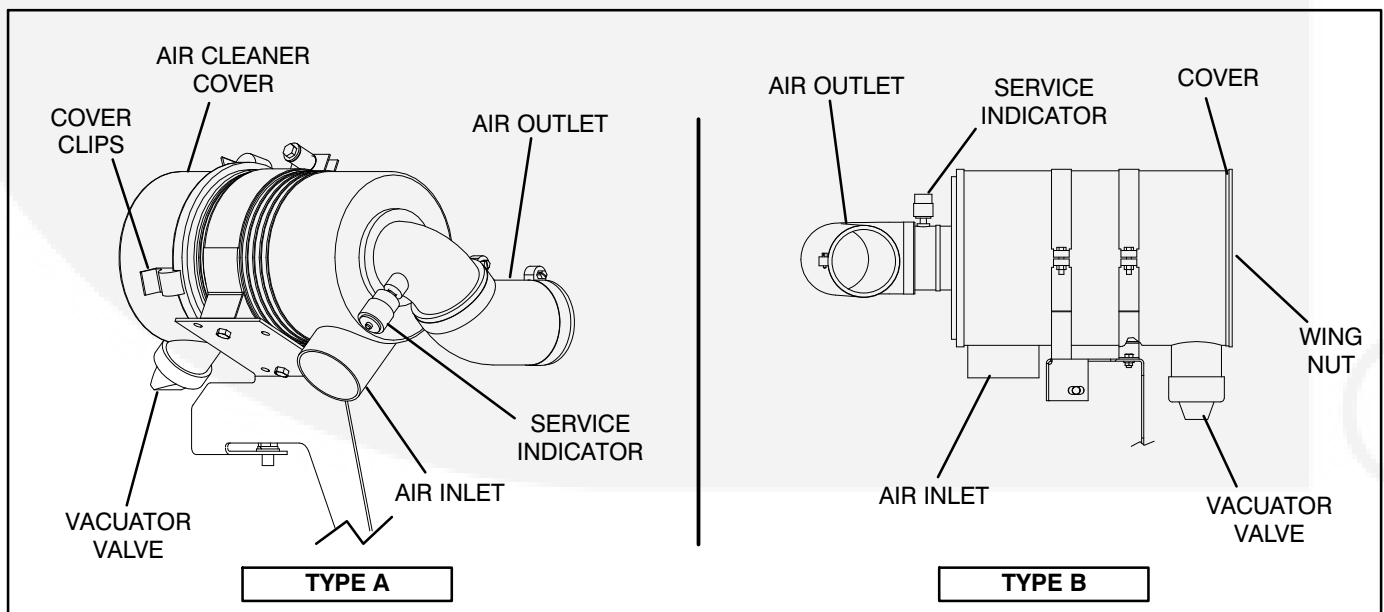

FIGURE 5-3. AIR CLEANER

## BATTERIES

**⚠ WARNING** *Ignition of explosive battery gases can cause severe personal injury or death. Arcing at battery terminals, light switch or other equipment, flame, pilot lights and sparks can ignite battery gas. Do not smoke, or switch trouble light ON or OFF near battery. Discharge static electricity from body before touching batteries by first touching a grounded metal surface.*

*Ventilate battery area before working on or near battery—Wear goggles—Stop genset and disconnect charger before disconnecting battery cables—Disconnect negative (-) cable first and reconnect last.*

**⚠ CAUTION** *Disconnect battery charger from AC source before disconnecting battery cables. Otherwise, disconnecting cables can result in voltage spikes damaging to DC control circuits of the set.*

Check the condition of the starting batteries at the interval specified in the Maintenance Table. To prevent dangerous arcing, always disconnect the negative ground cable from the battery before working on any part of the electrical system or the engine. Disregard the sections On Checking Specific Gravity and Checking Electrolyte Level if using a “maintenance-free” battery.

### Cleaning Batteries

**⚠ WARNING** *Electrolyte is a dilute sulfuric acid that is harmful to the skin and eyes. Do not get the substance in your eyes or contact with skin. Wear goggles and protective, rubber gloves and apron when servicing batteries.*

*In case of contact, immediately wash skin with soap and water. In case of contact, immediately flood eyes with large amounts of water for a minimum of 15 minutes. IMMEDIATELY CALL A PHYSICIAN.*

Keep the batteries clean by wiping them with a damp cloth whenever dirt appears excessive.

If corrosion is present around the terminal connections, remove battery cables and wash the terminals with a solution consisting of 1/4 pound of baking soda added to 1 quart of water. (This solution is also used for washing down spilled electrolyte.)

Be sure the vent plugs are tight to prevent cleaning solution from entering the cells.

After cleaning, flush the outside of the battery and surrounding areas with clean water.

Keep the battery terminals clean and tight. After making connections, coat the terminals with a light application of petroleum jelly or non-conductive grease to retard corrosion.

### Checking Specific Gravity

Use a battery hydrometer to check the specific gravity of the electrolyte in each battery cell.

Hold the hydrometer vertical and take the reading. Correct the reading by adding four gravity points (0.004) for every ten degrees the electrolyte temperature is above 80° F (27° C). A fully charged battery will have a corrected specific gravity of 1.260. Charge the battery if the reading is below 1.215.

### Checking Electrolyte Level

**⚠ CAUTION** *Do not add water in freezing weather unless the engine will run long enough (two to three hours) to assure a thorough mixing of water and electrolyte.*

Check the level of the electrolyte (acid and water solution) in the batteries at least every 200 hours of operation.

Fill the battery cells to the bottom of the filler neck. If cells are low on water, add distilled water and recharge. If one cell is low, check case for leaks. Keep the battery case clean and dry. An accumulation of moisture will lead to a more rapid discharge and battery failure.

## Battery Replacement

Always replace the starting battery with the same number and type (vented, lead acid). Properly dispose of battery in accordance with local environmental agency requirements.

**⚠WARNING** *Electrolyte or explosion of battery can cause severe personal injury or death. Do not mutilate or burn the battery in a fire for disposal.*

*Damage to case will release electrolyte which is harmful to the skin and eyes and is also toxic. Burning of battery may cause an explosion.*

## NiCad Batteries

NiCad (nickel-cadmium) battery systems are often specified where extreme high or low ambient temperature is expected because their performance is less affected by temperature extremes than that of lead-acid batteries.

NiCad batteries require special battery chargers in order to bring them to the full-charge level. These chargers must be provided with filter to reduce “charge ripple” which can disrupt engine and generator control systems.





# 6. Operating Recommendations

---

## **NO-LOAD OPERATION**

Periods of no load operation should be held to a minimum. If it is necessary to keep the engine running for long periods of time when no electric output is required, best engine performance will be obtained by connecting a load bank of at least 30 percent of nameplate rating.

## **EXERCISE PERIOD**

Generator sets on continuous standby must be able to go from a cold start to being fully operational in a matter of seconds. This can impose a severe burden on engine parts.

Regular exercising keeps engine parts lubricated, prevents oxidation of electrical contacts and in general helps provide reliable engine starting.

Exercise the generator set at least once a month for a minimum of 30 minutes, under not less than 30 percent of the nameplate rating.

## **LOW OPERATING TEMPERATURE**

Use a coolant heater if a separate source of power is available. The optional heater will help provide reliable starting under adverse weather conditions. Be sure the voltage of the separate power source is correct for the heater element rating.

## **HIGH OPERATING TEMPERATURE**

Refer to the genset nameplate for the maximum ambient operating temperature, if applicable.





**THIS PAGE LEFT INTENTIONALLY BLANK**





[www.power.cummins.com](http://www.power.cummins.com)

Copyright © 2015 Cummins Power Generation Inc. All rights reserved.

Cummins Power Generation, the "C" logo, and Cummins are registered trademarks of Cummins Inc. PowerCommand, AmpSentry, InPower and "Our energy working for you." are trademarks of Cummins Power Generation. Other company, product, or service names may be trademarks or service marks of others. Specifications are subject to change without notice.

